

**BLANCO UNIT**  
drink. prep. clean.

 **GERMANY**  
SINCE 1925



**VASCHE SILGRANIT®**
**da pag. 25**

BLANCO ETAGON	28-33	BLANCO SUBLINE 500-U Black Edition	42	BLANCO SUBLINE 500-IF/A SteelFrame	43
BLANCO SUBLINE-U, -F	34-41	BLANCO SUBLINE 500-IF SteelFrame	43		

**VASCHE ACCIAIO INOX**
**da pag. 45**

BLANCO ANDANO -U, -IF, -IF/A	84-85	BLANCO CLARON-U, -IF, -IF/A	46-55	BLANCO ZEROX Dark Steel	56-59
BLANCO ANDANO XL 6 S-IF Compact	95	BLANCO ETAGON-U, -IF, -IF/A	80-83	BLANCO ZEROX Durinox	76-79
BLANCO ANDANO XL 6 S-IF	95	BLANCO SOLIS-U	96-103	BLANCO ZEROX -U, -IF, -IF/A	60-67
BLANCO CLARON Durinox	70-75	BLANCO SUPRA -U, -IF, -IF/A	104-107		

**VASCHE CERAMICA**
**da pag. 108**

BLANCO SUBLINE-U	112-113	BLANCO PALONA 6	114
BLANCO ETAGON 500-U	110	BLANCO PANOR 60	115
BLANCO ETAGON 6	111		

**LAVELLI SILGRANIT®**
**da pag. 116**

BLANCO DALAGO, -F	134-137	BLANCO NAYA	120-123	BLANCO VINTERA XL 9	119
BLANCO ELON	128-129	BLANCO PLEON	124-127	BLANCO ZIA	142-149
BLANCO LEGRA	146-149	BLANCORONDO	150		
BLANCO METRA	130-133	BLANCO SONA	130-141		

**LAVELLI ACCIAIO INOX**
**da pag. 151**

BLANCO CLASSIMO-IF	156-159	BLANCO DIVON II	152-155	BLANCO RONDOSOL, -IF	179
BLANCODANA 45	176	BLANCO LANTOS-IF	164-167	BLANCO TIPO	168-171
BLANCODANA 6	177	BLANCO LEMIS-IF	160-163		
BLANCO DINAS	172-175	BLANCO PLENTA	178		

**MISCELATORI CUCINA**
**da pag. 180**

BLANCO ALTA, -S Compact	194	BLANCO FONTAS	198	BLANCO MIDA, -S	214
BLANCO AMBIS, -S	207	BLANCO FONTAS-S II	199	BLANCO MIDA-S Nero opaco	215
BLANCO AVONA, -S	199	BLANCO FONTAS, -S II Nero Opaco	197	BLANCO MILA, -S	216
BLANCO ANTAS, -S	212	BLANCO FONTAS, S II Satin Gold	200	BLANCO MILA Nero Opaco	217
BLANCO CANDOR, -S	208	BLANCO JANDORA, -S	210	BLANCO MILI	218
BLANCO CARENA, -S	201	BLANCO JURENA, -S	202	BLANCO MILI Nero Opaco	218
BLANCO CATRIS-S	195	BLANCO LANORA, -S	209	BLANCO PANERA-S	185
BLANCO CATRIS-S Flexo	195	BLANCO LANORA-F, -S-F	222	BLANCO SOLENTA-S	184
BLANCO CATRIS-S Nero Opaco	195	BLANCO LARESSA-F	224	BLANCO SOLENTA-S Senso	192
BLANCO CORESSA-F	224	BLANCO LINEE, -S	188, 189	BLANCO SONEA-S Flexo	192
BLANCO CUCULINA-S Duo	186	BLANCO LINUS, -S	203, 206	BLANCO TIVO, -S	211
BLANCO CUCULINA-S Mini	187	BLANCO LINUS, -S Nero Opaco	204	BLANCO TIVO-F, -S-F	221
BLANCO CUCULINA-S	187	BLANCO LINUS, -S Satin Gold	205	BLANCO TRIMA	213
BLANCO DARAS, -S	219	BLANCO LINUS-F, -S-F	223	BLANCO TRIMA Satin Gold	213
BLANCO DARAS-F, -S-F	225	BLANCO LIVIA-S	191	BLANCO VONDA	190
BLANCO ELOSOCPE-F II	220	BLANCO LIVIA-S Satin Gold	191		

**drink.systems**
**183**

BLANCO drink.filter EVOL-S Pro	183
--------------------------------	-----

**DISPENSER DI SAPONE**
**da pag. 226**

BLANCO LATO Cromato, Nero Opaco	229	BLANCO TANGO	226
BLANCO LATO Satin Gold	230	BLANCO TIGA	226
BLANCO LATO finitura Silgranit	230	BLANCO TORRE	227
BLANCO LIVIA	229	BLANCO TORRE Satin Gold	227
BLANCO LIVIA Satin Gold	229	BLANCO YANO	226
BLANCO PIONA	226		

**COMANDI SALTARELLO**
**da pag. 231**

BLANCO COMFORT	231
BLANCO COMFORT Nero Opaco	231
BLANCO LIVIA	232
BLANCO LIVIA Satin Gold	232

**SISTEMI PER RACCOLTA DIFFERENZIATA**
**da pag. 233**

BLANCO BOTTON Pro Manuale	240	BLANCO SELECT II	235
BLANCO BOTTON Pro Automatica	241	BLANCO SELECT II Orga	234
BLANCO FLEXON II	237-238	BLANCO SINGOLO	243
BLANCO FLEXON II Low	239	BLANCO SOLON-IF	242

**ACCESSORI RACCOLTA DIFFERENZIATA**
**244-245**
**DISSIPATORI DI RIFIUTI**
**da pag. 246**

BLANCO FWD Lite	249	BLANCO FWD Medium	248	BLANCO FWD Max	247
-----------------	-----	-------------------	-----	----------------	-----

**ACCESSORI, MANUTENZIONE E CURA**
**da pag. 250**

ACCESSORI	251-255, 259-259
BLANCO CARE	256-257

**VARIE, INFORMAZIONI**
**da pag. 260**

COMANDI SALTARELLO	264-265
INFORMAZIONI	266-276
SCHEMI TROPPOPIENO	260
SOLUZIONI DI INSTALLAZIONE	261-262

# CHE COS'È BLANCO UNIT?

Ingegnosità in cucina, con competenza tedesca.



Una BLANCO UNIT è la soluzione ottimale per l'area del lavello in cucina, perfettamente integrata, progettata per semplificare la vita quotidiana in cucina. La combinazione di lavello, miscelatore, organizzazione del mobile sottolavello e degli accessori BLANCO, semplifica il lavoro in cucina e migliora l'esperienza con l'acqua. Tutto il necessario per bere, preparare e pulire, tutto in un unico posto.

L'area del lavello gioca un ruolo fondamentale nelle attività in cucina: oltre il 60 per cento del tempo in cucina viene trascorso in questo spazio. BLANCO UNIT soddisfa ogni necessità, essendo il punto principale in cui bere e cucinare, dove preparare i pasti e un sistema unico per tenere tutto pulito e sistemato.

Ci sono infinite possibilità di personalizzare una BLANCO UNIT in base al design e alle proprie preferenze. All'interno di questo listino, a fondo pagina, troverete i nostri suggerimenti per creare la vostra BLANCO UNIT personalizzata.

Fondata nel 1925 a Oberderdingen, Germania, BLANCO ha oltre 95 anni di esperienza internazionale, portando prodotti di alta qualità e soluzioni funzionali nelle cucine di tutto il mondo.

 **GERMANY**  
SINCE 1925

**BLANCO UNIT**  
drink. prep. clean.





# COME SCEGLIERE LA PROPRIA BLANCO UNIT

La soluzione integrata di lavello, miscelatore e sistema di raccolta differenziata.



## Progettare la cucina

Quando si pianifica la propria cucina, pensare alle proprie necessità quotidiane è la chiave per creare uno spazio che supporti appieno il proprio stile di vita. Dai più golosi, agli chefs gourmet, noi tutti utilizziamo attivamente la cucina e la riconosciamo come il cuore della casa. Siamo tutti diversi, ma tutti vogliamo godere pienamente del tempo passato in cucina. Ecco perché la progettazione comincia dalle proprie abitudini. Capire il modo in cui si usa la cucina, i gesti di ogni giorno sono un ottimo punto di partenza.

Un altro punto chiave è il design. Definire il proprio stile, i colori e i materiali è molto importante per trovare i giusti elementi per la propria cucina. BLANCO vi invita a esplorare e sperimentare il suo design, i suoi colori e le sue combinazioni: mescolare e combinare per creare la perfetta area del lavello, secondo il proprio gusto e stile di vita.

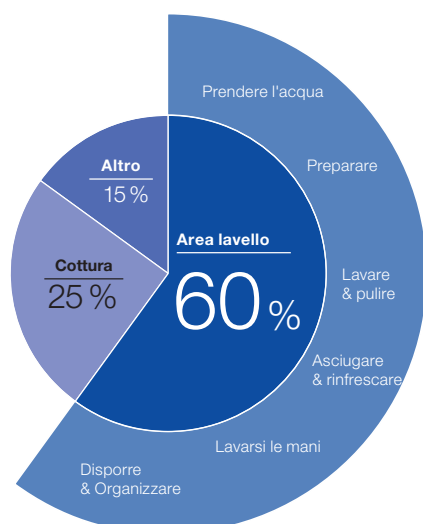

## Il ruolo chiave dell'area lavello

L'area più frequentata della cucina è l'area lavello, in cui trascorriamo oltre il 60% del nostro tempo. Anche se l'utilizzo può variare, generalmente tutti noi consideriamo l'area lavello un punto chiave: come avamposto di igiene, in cui eliminare lo sporco e i batteri dagli alimenti e dalle stoviglie, per lavarsi le mani, per bere (acqua fresca, o da far bollire, per es. per il tè), per prelevare l'acqua di cottura e come area di raccolta degli scarti alimentari e dei rifiuti.



## Una BLANCO UNIT parte dal lavello

Esistono forti tendenze di design della cucina per vari stili di lavello, ma la decisione dovrebbe essere presa in base a come verrà utilizzata l'area del lavello. Ci sono molte opzioni da considerare: vasca singola o vasca doppia, con o senza gocciolatoio, sottotop, sopratop o filotop, in materiale Silgranit, acciaio inox o ceramica. Con così tante opzioni, bisogna soffermarsi a considerare i propri bisogni e le necessità.



## Stili, caratteristiche e finiture dei miscelatori

I nostri miscelatori di alta qualità sono durevoli e semplici da usare. Con un'ampia gamma di design e finiture, caratteristiche molto utili come la doccetta estensibile o il filtraggio dell'acqua e persino modelli speciali per l'installazione su finestre, determinano quale stile si adatta al design della cucina e soddisfa le esigenze quotidiane in cucina. Tenere conto delle dimensioni critiche come altezza e portata dell'acqua, assicurerà che vi sia lo spazio adeguato sopra il miscelatore e che esso sia proporzionato alle dimensioni del lavello.

## Accessori che migliorano la funzionalità

I giusti accessori che supportano il lavoro in cucina. Migliora la tua BLANCO UNIT con un dispenser di sapone abbinato, un robusto tagliere che può essere posizionato sopra la vasca o una griglia pieghevole, creando un flusso di lavoro continuo. Gli accessori aiuteranno a personalizzare la UNIT, soddisfacendo specifiche esigenze.



## Sfruttare al massimo la base sottolavello

La combinazione di un miscelatore e un lavello BLANCO ha vantaggi che dureranno tutta la vita, ma per sfruttare davvero al meglio questa zona, bisogna organizzarla al meglio! I mobili sottolavello hanno un grande potenziale per ottimizzare i flussi di lavoro conservando i prodotti per la pulizia e/o i sistemi per la raccolta differenziata, organizzati e facilmente accessibili, fornendo una soluzione pulita e flessibile proprio dove serve.

## Lasciati ispirare

Come punto di partenza, ti consigliamo di trovare l'ispirazione per la tua UNIT nelle pagine seguenti. Contengono una selezione accurata di prodotti che si combinano perfettamente per creare un'area lavello adatta alle proprie esigenze. Trasforma le faccende quotidiane in momenti gioiosi con una pratica e bella BLANCO UNIT.

Gira la pagina per trovare l'ispirazione per la tua UNIT personalizzata.

# UNIT Inspirations



- Questa UNIT soddisfa le esigenze di uno chef casalingo.
- Un solido miscelatore in acciaio inox a canna alta e doccetta estraibile a doppio getto che raggiunge ogni angolo del lavello.
- Il grande volume della vasca e il bordo ribassato (0,5 cm) offrono ampio spazio e proteggono il piano di lavoro.
- Il sistema di raccolta differenziata interno al mobile offre ordine e praticità, tenendo tutti i tuoi utensili da cucina a portata di mano, ma fuori dalla vista.

**NUOVO**

## Miscelatore



## Vasca/lavello



## Sistema per raccolta differenziata

**Installazione  
sopratop**

### JANDORA-S

Acciaio massiccio spazzolato  
v. pag. 221

### PLEON 6

SILGRANIT nero  
v. pag. 132

### FLEXON II XL 60/3

v. pag. 250

#### Altre opzioni disponibili:

PLEON è disponibile in altri colori. V. pagg. 130-133

## Accessori opzionali



Tagliere in legno multistrato

1230700  
v. pag. 277



Vaschetta angolare  
multifunzione

1235866  
v. pag. 273



Dispenser di sapone PIONA

1517667  
v. pag. 237



Controllo a piede MOVEX

1519357  
v. pag. 256



**NUOVO**

- Questa UNIT supporta le esigenze quotidiane degli chef amatoriali.
- Miscelatore semi-professionale a canna alta, con supporto magnetico e doccetta a doppio getto che raggiunge ogni angolo del lavello.
- La combinazione di una grande vasca con gocciolatoio aggiunge funzionalità a quest'area, semplificando ogni fase di lavoro in cucina.
- Il sistema di raccolta differenziata interno al mobile offre ordine e praticità, tenendo tutti i tuoi utensili da cucina a portata di mano, ma fuori dalla vista.

## Miscelatore

## Vasca/lavello

## Sistema per raccolta differenziata



**Installazione  
sopratop**



### SONEA-S Flexo

Acciaio massiccio spazzolato  
v. pag. 204

### METRA XL 6 S

SILGRANIT bianco  
v. pag. 137

### FLEXON II XL 60/3

v. pag. 250

#### Altre opzioni disponibili:

METRA è disponibile in altri colori. V. pag. 136

## Accessori opzionali



Tagliere a ponte in legno massello

1218313  
v. pag. 276



Tagliere a ponte in materiale sintetico bianco

1217611  
v. pag. 276



Vaschetta angolare multifunzione

1235866  
v. pag. 273



Dispenser di sapone PIONA

1517537  
v. pag. 237



Controllo a piede MOVEX

1519357  
v. pag. 256



# UNIT Inspirations



- Forme moderne e funzionalità premium creano un'interazione perfetta tra lavello e miscelatore, per un flusso di lavoro ottimale in cucina.
- Il miscelatore 3 in 1 eroga acqua filtrata, calda e fredda
- Eccezionale funzionalità della vasca, grazie al gradino integrato e alle barre in acciaio inox ETAGON in dotazione
- Il sistema di raccolta differenziata interno al mobile offre ordine e praticità, tenendo tutti i tuoi utensili da cucina a portata di mano, ma fuori dalla vista.

**NUOVO**

## Miscelatore



## Vasca/lavello



## Sistema per raccolta differenziata



Installazione  
filotop



### EVOL-S Pro Filtrò

Finitura PVD Steel  
v. pag. 192

### ETAGON 500-IF/A

Acciaio inox  
v. pag. 90

### SELECT II 60/2

v. pag. 247

## Accessori opzionali



Vaschetta forata in acciaio inox

1231396  
v. pag. 276



Set rompigitto per miscelatori

1521746  
v. pag. 189



Comando saltarello COMFORT

1225112  
v. pag. 2413



- Un miscelatore moderno abbinato a un lavello nei bellissimi colori Silgranit, che aggiungono un tocco di stile a qualsiasi cucina.
- Questa UNIT ha un miscelatore con doccetta estraibile e un'ampia vasca che agevola il lavaggio e la preparazione del cibo.
- Una funzionalità extra si aggiunge grazie al sistema per raccolta differenziata dei rifiuti, posizionata direttamente sotto al lavello, che permette di tenere la cucina pulita e ordinata, il tutto a portata di anta.
- Materiali di alta qualità, per una lunga durata della vostra UNIT nel tempo.

**NUOVO**

## Miscelatore



## Vasca/lavello



## Sistema per raccolta differenziata



Installazione  
sopratop



### AMBIS-S

Acciaio massiccio spazzolato  
v. pag. 218

### NAYA 5

SILGRANIT grigio roccia,  
v. pag. 128

### FLEXON II XL 60/3

v. pag. 250

#### Altre opzioni disponibili:

NAYA 5 è disponibile in altri colori. V. pag. 126

## Accessori opzionali



Tagliere a ponte in legno massello

1218313  
v. pag. 276



Vaschetta multifunzione  
in acciaio inox

1223297  
v. pag. 275



Cestello inox  
con griglia per piatti

1507829  
v. pag. 275



Set rompigitto per miscelatori

1521746  
v. pag. 189



Dispenser di sapone LATO

1526817  
v. pag. 241-242

# VASCHE E LAVELLI BLANCO COLORI E FINITURE

## Acciaio inox



Acciaio inox  
Dark Steel

Acciaio inox  
Durinox

Acciaio inox  
satinato lucido

Acciaio inox  
satinato opaco

Acciaio inox

## Colori SILGRANIT®



nero

antracite

grigio roccia

aluminale

grigio vulcano

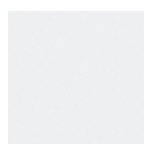

bianco

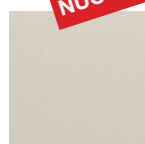

soft white



tartufo



caffè

## Colori ceramica



nero

basalto

bianco cristallo

magnolia  
brillante

## Legenda delle icone per vasche e lavelli



installazione  
SOPRATOP



installazione  
SOTTOTOP



installazione  
SOPRATOP (effetto semifilo)  
e FILOTOP



installazione  
FILOTOP



# MISCELATORI BLANCO

## COLORI E FINITURE

### Superfici metalliche



Cromato



Effetto inox



Ottone satinato



Grigio  
Manganese

### PVD



Finitura  
PVD steel



Satin Gold

### Acciaio inox



Acciaio inox  
satinato lucido



Acciaio inox  
satinato opaco

### Colori Speciali



Nero opaco

### Finitura Silgranit



nero

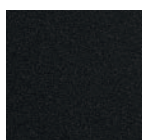

antracite



grigio roccia



alumetallic



grigio vulcano

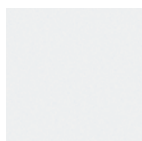

bianco

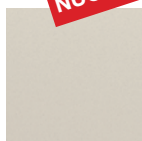

soft white

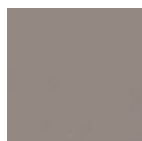

tartufo

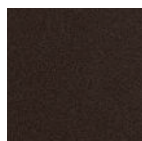

caffè

### Legenda delle icone per miscelatori



eroga la quantità  
di acqua desiderata



doccetta  
estraibile



installazione sottofinestra



sistema filtrante



doccetta estraibile  
con variatore di getto



connessione elettrica



versione con sensore  
di movimento



leva a sinistra

**Incasso sottotop** **Vasche** **SILGRANIT**

<p><b>ETAGON 700-U</b></p>  <p>SILGRANIT 730 x 460 mm</p>  <p>p. 29</p>	<p><b>ETAGON 500-U</b></p>  <p>SILGRANIT 530 x 460 mm</p>  <p>p. 30</p>	<p><b>SUBLINE 430/320-U</b></p>  <p>SILGRANIT 855 x 460 mm</p>  <p>p. 41</p>	<p><b>SUBLINE 340/160-U</b></p>  <p>SILGRANIT 555 x 460 mm</p>  <p>p. 40</p>	<p><b>SUBLINE 430/270-U</b></p>  <p>SILGRANIT 755 x 460 mm</p>  <p>p. 41</p>
<p><b>SUBLINE 350/350-U</b></p>  <p>SILGRANIT 730 x 460 mm</p>  <p>p. 41</p>	<p><b>SUBLINE 700-U Level</b></p>  <p>SILGRANIT 730 x 460 mm</p>  <p>p. 39</p>	<p><b>SUBLINE 800-U</b></p>  <p>SILGRANIT 830 x 460 mm</p>  <p>p. 39</p>	<p><b>SUBLINE 700-U</b></p>  <p>SILGRANIT 730 x 460 mm</p>  <p>p. 38</p>	<p><b>SUBLINE 500-U</b></p>  <p>SILGRANIT 530 x 460 mm</p>  <p>p. 38</p>
<p><b>SUBLINE 500-U Black Edition</b></p>  <p>SILGRANIT 530 x 460 mm</p>  <p>p. 42</p>	<p><b>SUBLINE 400-U</b></p>  <p>SILGRANIT 430 x 460 mm</p>  <p>p. 37</p>	<p><b>SUBLINE 320-U</b></p>  <p>SILGRANIT 350 x 460 mm</p>  <p>p. 36</p>	<p><b>SUBLINE 160-U</b></p>  <p>SILGRANIT 190 x 460 mm</p>  <p>p. 36</p>	

**Incasso sopratop e incasso sopratop/filotop** **Vasche** **SILGRANIT**

<p><b>ETAGON 8</b></p>  <p>SILGRANIT 780 x 510 mm</p>  <p>p. 31</p>	<p><b>ETAGON 6 Black Edition</b></p>  <p>SILGRANIT 600 x 510 mm</p>  <p>p. 33</p>	<p><b>ETAGON 6</b></p>  <p>SILGRANIT 600 x 510 mm</p>  <p>p. 32</p>
<p><b>SUBLINE 500-IF/A SteelFrame</b></p>  <p>SILGRANIT 543 x 510 mm</p>  <p>p. 43</p>	<p><b>SUBLINE 500-IF SteelFrame</b></p>  <p>SILGRANIT 543 x 510 mm</p>  <p>p. 43</p>	

**Incasso sottotop e incasso sopratop** **Vasche** **Ceramica**

<p><b>ETAGON 500-U</b></p>  <p>Ceramica 780 x 510 mm</p>  <p>p. 110</p>	<p><b>ETAGON 6</b></p>  <p>Ceramica 600 x 510 mm</p>  <p>p. 111</p>	<p><b>SUBLINE 350/150-U</b></p>  <p>Ceramica 600 x 510 mm</p>  <p>p. 113</p>	<p><b>SUBLINE 500-U</b></p>  <p>Ceramica 600 x 510 mm</p>  <p>p. 113</p>	<p><b>SUBLINE 375-U</b></p>  <p>Ceramica 600 x 510 mm</p>  <p>p. 113</p>
---	---	--	--	--

 installazione SOTTOTOP    
  installazione SOPRATOP    
  installazione SOPRATOP (effetto semifilo) e FILOTOP    
  installazione FILOTOP

**BLANCO PALONA 6**



Ceramica  
600 x 510 mm



p. 114

**BLANCO PANOR 60**



Ceramica  
600 x 510 mm



p. 115

**BLANCO ZEROX 700-U Dark Steel**



Acciaio inox Dark Steel  
740 x 440 mm



p. 59

**BLANCO ZEROX 500-U Dark Steel**



Acciaio inox Dark Steel  
540 x 440 mm



p. 58

**BLANCO CLARON 700-U Durinox**



Acciaio inox Durinox  
740 x 440 mm



p. 75

**BLANCO CLARON 500-U Durinox**



Acciaio inox Durinox  
540 x 440 mm



p. 74

**BLANCO CLARON 400-U Durinox**



Acciaio inox Durinox  
440 x 440 mm



p. 73

**BLANCO CLARON 340-U Durinox**



Acciaio inox Durinox  
380 x 440 mm



p. 72

**BLANCO CLARON 400/400-U**



Acciaio inox  
865 x 440 mm



p. 54

**BLANCO CLARON 340/180-U**



Acciaio inox  
585 x 440 mm



p. 53

**BLANCO CLARON 700-U**



Acciaio inox  
740 x 440 mm



p. 52

**BLANCO CLARON 550-U**



Acciaio inox  
590 x 440 mm



p. 51

**BLANCO CLARON 500-U**



Acciaio inox  
540 x 440 mm



p. 50

**BLANCO CLARON 450-U**



Acciaio inox  
490 x 440 mm



p. 49

**BLANCO CLARON 400-U**



Acciaio inox  
740 x 440 mm



p. 48

**BLANCO CLARON 340-U**



Acciaio inox  
380 x 440 mm



p. 47

**BLANCO CLARON 180-U**



Acciaio inox  
220 x 440 mm



p. 47

**BLANCO ZEROX 700-U Durinox**



Acciaio inox Durinox  
740 x 440 mm



p. 79

**BLANCO ZEROX 500-U Durinox**



Acciaio inox Durinox  
540 x 440 mm



p. 78

**BLANCO ZEROX 400-U Durinox**



Acciaio inox Durinox  
440 x 440 mm



p. 77

**BLANCO ZEROX 400/400-U**



Acciaio inox  
865 x 440 mm



p. 67

**BLANCO ZEROX 340/180-U**



Acciaio inox  
585 x 440 mm



p. 66

**BLANCO ZEROX 700-U**



Acciaio inox  
740 x 440 mm



p. 65

**BLANCO ZEROX 550-U**



Acciaio inox  
590 x 440 mm



p. 64

**BLANCO ZEROX 500-U**



Acciaio inox  
540 x 440 mm



p. 63



installazione SOTTOTOP



installazione SOPRATOP



installazione SOPRATOP  
(effetto semifilo)  
e FILOTOP



installazione FILOTOP



**BLANCO ZEROX 450-U**



Acciaio inox  
490 x 440 mm

p. 62

**BLANCO ZEROX 400-U**



Acciaio inox  
440 x 440 mm

p. 62

**BLANCO ETAGON 700-U**



Acciaio inox  
740 x 440 mm

p. 83

**BLANCO ETAGON 500-U**



Acciaio inox  
540 x 440 mm

p. 82

**BLANCO ANDANO 500/180-U**



Acciaio inox  
745 x 440 mm

p. 94

**BLANCO ANDANO 400/400-U**



Acciaio inox  
865 x 440 mm

p. 93

**BLANCO ANDANO 340/340-U**



Acciaio inox  
745 x 440 mm

p. 92

**BLANCO ANDANO 340/180-U**



Acciaio inox  
585 x 440 mm

p. 91

**BLANCO ANDANO 700-U**



Acciaio inox  
740 x 440 mm

p. 90

**BLANCO ANDANO 500-U**



Acciaio inox  
540 x 440 mm

p. 89

**BLANCO ANDANO 450-U**



Acciaio inox  
490 x 440 mm

p. 88

**BLANCO ANDANO 400-U**



Acciaio inox  
440 x 440 mm

p. 87

**BLANCO ANDANO 340-U**



Acciaio inox  
380 x 440 mm

p. 86

**BLANCO ANDANO 180-U**



Acciaio inox  
220 x 440 mm

p. 86

**BLANCO SOLIS 340/180-U**



Acciaio inox  
585 x 440 mm

p. 103

**BLANCO SOLIS 700-U**



Acciaio inox  
740 x 440 mm

p. 102

**BLANCO SOLIS 500-U**



Acciaio inox  
540 x 440 mm

p. 101

**BLANCO SOLIS 450-U**



Acciaio inox  
490 x 440 mm

p. 100

**BLANCO SOLIS 400-U**



Acciaio inox  
440 x 440 mm

p. 99

**BLANCO SOLIS 340-U**



Acciaio inox  
380 x 440 mm

p. 98

**BLANCO SOLIS 180-U**



Acciaio inox  
380 x 440 mm

p. 98

**BLANCO SUPRA 340/340-U**



Acciaio inox  
765 x 450 mm

p. 106

**BLANCO SUPRA 500-U**



Acciaio inox  
530 x 430 mm

p. 107

**BLANCO SUPRA 450-U**



Acciaio inox  
490 x 430 mm

p. 106

**BLANCO SUPRA 400-U**



Acciaio inox  
430 x 430 mm

p. 105

**BLANCO SUPRA 340-U**



Acciaio inox  
370 x 430 mm

p. 105

 installazione SOTTOTOP

 installazione SOPRATOP

 installazione SOPRATOP (effetto semifilo) e FILOTOP

 installazione FILOTOP

BLANCO ZEROX 700-IF Dark Steel



Acciaio inox Dark Steel  
740 x 440 mm



BLANCO ZEROX 500-IF Dark Steel



Acciaio inox Dark Steel  
540 x 440 mm



BLANCO CLARON 700-IF/A Durinox



Acciaio inox Durinox  
760 x 510 mm



BLANCO CLARON 500-IF/A Durinox



Acciaio inox Durinox  
560 x 510 mm



BLANCO CLARON 400-IF/A Durinox



Acciaio inox Durinox  
460 x 510 mm



BLANCO CLARON 400/400-IF/A



Acciaio inox  
885 x 510 mm



BLANCO CLARON 340/180-IF/A



Acciaio inox  
605 x 510 mm



BLANCO CLARON 700-IF/A



Acciaio inox  
760 x 510 mm



BLANCO CLARON 550-IF/A



Acciaio inox  
610 x 510 mm



BLANCO CLARON 500-IF/A



Acciaio inox  
560 x 510 mm



BLANCO CLARON 400-IF/A



Acciaio inox  
460 x 510 mm



BLANCO ZEROX 700-IF/A Durinox



Acciaio inox Durinox  
760 x 510 mm



BLANCO ZEROX 500-IF/A Durinox



Acciaio inox Durinox  
560 x 510 mm



BLANCO ZEROX 400-IF/A Durinox



Acciaio inox Durinox  
460 x 510 mm



BLANCO ZEROX 400/400-IF/A



Acciaio inox  
605 x 510 mm



BLANCO ZEROX 340/180-IF/A



Acciaio inox  
605 x 510 mm



BLANCO ZEROX 700-IF/A



Acciaio inox  
760 x 510 mm



BLANCO ZEROX 550-IF/A



Acciaio inox  
610 x 510 mm



BLANCO ETAGON 700-IF/A



Acciaio inox  
740 x 500 mm



BLANCO ETAGON 500-IF/A



Acciaio inox  
540 x 500 mm



BLANCO SUPRA 500-IF/A R12



Acciaio inox  
540 x 500 mm



BLANCO SUPRA 400-IF/A R12



Acciaio inox  
440 x 500 mm



BLANCO ANDANO 400/400-IF/A



Acciaio inox  
865 x 500 mm



BLANCO ANDANO 340/340-IF/A



Acciaio inox  
745 x 500 mm



BLANCO ANDANO 340/180-IF/A



Acciaio inox  
585 x 500 mm



BLANCO ANDANO 700-IF/A



Acciaio inox  
740 x 500 mm



BLANCO ANDANO 500-IF/A



Acciaio inox  
540 x 500 mm



BLANCO ANDANO 400-IF/A



Acciaio inox  
440 x 500 mm



BLANCO SOLIS 340/180-IF/A



Acciaio inox  
585 x 500 mm



BLANCO SOLIS 700-IF/A



Acciaio inox  
700 x 500 mm



BLANCO SOLIS 400-IF/A



Acciaio inox  
500 x 500 mm



BLANCO SOLIS 340-IF/A



Acciaio inox  
400 x 500 mm

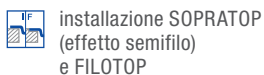

PANORAMICA  
PRODOTTI

**BLANCORONDO**



SILGRANIT  
Ø 450 mm



p. 150

**BLANCO ELON XL 8 S**



SILGRANIT  
860 x 500 mm



p. 129

**BLANCO ELON XL 6 S**



SILGRANIT  
780 x 500 mm



p. 129

**BLANCO ELON 45 S**



SILGRANIT  
650 x 500 mm



p. 129

**BLANCO PLEON 9**



SILGRANIT  
860 x 500 mm



p. 127

**BLANCO PLEON 8**



SILGRANIT  
700 x 510 mm



p. 127

**BLANCO PLEON 6 Split**



SILGRANIT  
615 x 510 mm



p. 126

**BLANCO PLEON 6**



SILGRANIT  
615 x 510 mm



p. 126

**BLANCO PLEON 5**



SILGRANIT  
515 x 510 mm



p. 126

**BLANCO NAYA 8 S**



SILGRANIT  
1160 x 500 mm

p. 123

**BLANCO NAYA XL 9**



SILGRANIT  
860 x 510 mm



p. 123

**BLANCO NAYA 6**



SILGRANIT  
615 x 510 mm



p. 122

NUOVO

**BLANCO NAYA 5**



SILGRANIT  
515 x 510 mm



p. 122

NUOVO

**BLANCO NAYA 45**



SILGRANIT  
465 x 510 mm



p. 122

NUOVO

**BLANCO DALAGO 8**



SILGRANIT  
815 x 510 mm



p. 137

**BLANCO DALAGO 8-F**



SILGRANIT  
805 x 500 mm



p. 137

**BLANCO DALAGO 6**



SILGRANIT  
615 x 510 mm



p. 137

**BLANCO DALAGO 6-F**



SILGRANIT  
605 x 500 mm



p. 137

**BLANCO DALAGO 5**



SILGRANIT  
515 x 510 mm



p. 136

**BLANCO DALAGO 5 -F**



SILGRANIT  
515 x 510 mm



p. 136

**BLANCO DALAGO 45**



SILGRANIT  
465 x 510 mm



p. 136

**BLANCO DALAGO 45-F**



SILGRANIT  
455 x 500 mm



p. 136

**BLANCO METRA 9 E**



SILGRANIT  
830 x 830 mm



p. 133

**BLANCO METRA 8 S**



SILGRANIT  
1160 x 500 mm

p. 133

**BLANCO METRA 9**



SILGRANIT  
860 x 500 mm



p. 133

**BLANCO METRA 6 S**



SILGRANIT  
1000 x 500 mm



p. 132

**BLANCO METRA 6 S Compact**



SILGRANIT  
780 x 500 mm



p. 132

**BLANCO METRA 6**



SILGRANIT  
615 x 500 mm



p. 132

**BLANCO METRA XL 6 S**



SILGRANIT  
1000 x 500 mm



p. 131

**BLANCO METRA 5 S**



SILGRANIT  
860 x 500 mm



p. 131

**BLANCO METRA 45 S**



SILGRANIT  
780 x 500 mm



p. 131



installazione SOTTOTOP



installazione SOPRATOP



installazione SOPRATOP  
(effetto semifilo)  
e FILOTOP



installazione FILOTOP

BLANCO SONA 8 S



SILGRANIT  
1160 x 500 mm p. 141

BLANCO SONA 9



SILGRANIT  
860 x 500 mm p. 141

BLANCO SONA 8



SILGRANIT  
780 x 500 mm p. 141

BLANCO SONA 6 S



SILGRANIT  
1000 x 500 mm p. 140

BLANCO SONA XL 6 S



SILGRANIT  
1000 x 500 mm p. 140

BLANCO SONA 5 S



SILGRANIT  
860 x 500 mm p. 140

BLANCO SONA 45 S



SILGRANIT  
780 x 500 mm p. 140

BLANCO ZIA 8 S



SILGRANIT  
1160 x 500 mm p. 145

BLANCO ZIA 9



SILGRANIT  
860 x 500 mm p. 145

BLANCO ZIA 8



SILGRANIT  
860 x 500 mm p. 145

BLANCO ZIA 6 S



SILGRANIT  
1000 x 500 mm p. 144

BLANCO ZIA XL 6 S



SILGRANIT  
1000 x 500 mm p. 144

BLANCO ZIA XL 6 S Compact



SILGRANIT  
780 x 500 mm p. 144

BLANCO ZIA 5 S



SILGRANIT  
860 x 500 mm p. 143

BLANCO ZIA 45 SL



SILGRANIT  
860 x 500 mm p. 143

BLANCO LEGRA 8 S



SILGRANIT  
1160 x 500 mm p. 149

BLANCO LEGRA 9



SILGRANIT  
860 x 500 mm p. 149

BLANCO LEGRA 8



SILGRANIT  
780 x 500 mm p. 149

BLANCO LEGRA 6 S



SILGRANIT  
1000 x 500 mm p. 148

BLANCO LEGRA XL 6 S



SILGRANIT  
860 x 500 mm p. 148

BLANCO LEGRA 45 S



SILGRANIT  
780 x 500 mm p. 148

BLANCO VINTERA



SILGRANIT  
896 x 510 mm p. 119



**BLANCO CLARON 6 S-IF**



Acciaio inox  
1000 x 510 mm



p. 55

**BLANCO CLARON 5 S-IF**



Acciaio inox  
1000 x 510 mm



p. 55

**BLANCO CLARON 4 S-IF**



Acciaio inox  
780 x 510 mm



p. 55

**BLANCO DIVON II 8 S-IF**



Acciaio inox  
1160 x 510 mm



p. 155

**BLANCO DIVON II 8-IF**



Acciaio inox  
860 x 510 mm



p. 155

**BLANCO DIVON II 6 S-IF**



Acciaio inox  
1000 x 510 mm



p. 158

**BLANCO DIVON II 5 S-IF**



Acciaio inox  
1000 x 510 mm



p. 154

**BLANCO DIVON II 45 S-IF**



Acciaio inox  
860 x 510 mm



p. 154

**BLANCO CLASSIMO 8 S-IF**



Acciaio inox  
1160 x 500 mm



p. 159

**BLANCO CLASSIMO 8-IF**



Acciaio inox  
860 x 500 mm



p. 159

**BLANCO CLASSIMO XL 6 S-IF**



Acciaio inox  
1000 x 500 mm



p. 158

**BLANCO CLASSIMO 6 S-IF**



Acciaio inox  
1000 x 500 mm



p. 158

**BLANCO CLASSIMO 45 S-IF**



Acciaio inox  
860 x 500 mm



p. 158

**BLANCO LEMIS 8 S-IF**



Acciaio inox  
1160 x 500 mm



p. 163

**BLANCO LEMIS 8-IF**



Acciaio inox  
860 x 500 mm



p. 163

**BLANCO LEMIS 6 S-IF**



Acciaio inox  
1000 x 500 mm



p. 163

**BLANCO LEMIS 6-IF**



Acciaio inox  
615 x 500 mm



p. 166

**BLANCO LEMIS XL 6 S-IF**



Acciaio inox  
1000 x 500 mm



p. 162

**BLANCO LEMIS XL 6 S-IF Compact**



Acciaio inox  
780 x 500 mm



p. 162

**BLANCO LEMIS 45 S-IF**



Acciaio inox  
860 x 500 mm



p. 162

**BLANCO DINAS 45 S**



Acciaio inox  
1000 x 500 mm



p. 173

**BLANCO DINAS 45 S Advanced**



Acciaio inox  
1000 x 500 mm



p. 173

**BLANCO DINAS XL 6 S**



Acciaio inox  
860 x 500 mm



p. 173

**BLANCO DINAS XL 6 S Advanced**



Acciaio inox  
860 x 500 mm



p. 173

**BLANCO DINAS 6 S**



Acciaio inox  
1160 x 500 mm



p. 174

**BLANCO DINAS 6 S Advanced**



Acciaio inox  
1160 x 500 mm



p. 174

**BLANCO DINAS 8**



Acciaio inox  
860 x 500 mm



p. 174

**BLANCO DINAS 8 Advanced**



Acciaio inox  
860 x 500 mm



p. 174

**BLANCO DINAS 8 S**



Acciaio inox  
860 x 500 mm



p. 175

**BLANCO DINAS 8 S Advanced**



Acciaio inox  
860 x 500 mm



p. 175



installazione SOTTOTOP



installazione SOPRATOP



installazione SOPRATOP  
(effetto semifilo)  
e FILOTOP



installazione FILOTOP

BLANCO LANTOS 45 S-IF Compact



Acciaio inox  
768 x 488 mm



BLANCO LANTOS 45 S-IF Salto



Acciaio inox  
860 x 500 mm



BLANCO LANTOS XL 6 S-IF Compact



Acciaio inox  
780 x 500 mm



BLANCO LANTOS XL 6 S-IF



Acciaio inox  
1000 x 500 mm



BLANCO LANTOS 6-IF



Acciaio inox  
593 x 488 mm



BLANCO LANTOS 6 S-IF



Acciaio inox  
1000 x 500 mm



BLANCO LANTOS 8-IF Compact



Acciaio inox  
768 x 488 mm



BLANCO LANTOS 8 S-IF Compact



Acciaio inox  
860 x 500 mm



BLANCO TIPO 45



Acciaio inox  
480 x 500 mm



BLANCO TIPO 45 S Compact



Acciaio inox  
780 x 500 mm



BLANCO TIPO 45 S



Acciaio inox  
860 x 500 mm



BLANCO TIPO II 6 S



Acciaio inox  
950 x 500 mm



BLANCO TIPO 8



Acciaio inox  
860 x 500 mm



BLANCO TIPO 8 S Compact



Acciaio inox  
1160 x 500 mm



BLANCO RONDOSOL



Acciaio inox  
480 x 390 mm



BLANCO RONDOSOL-IF



Acciaio inox  
480 x 390 mm



BLANCO PLENTA



Acciaio inox  
860 x 500 mm



BLANCODANA 6



Acciaio inox  
605 x 500 mm



BLANCODANA 45



Acciaio inox  
480 x 500 mm



## Miscelatori

**BLANCO SOLENTA-S Senso**  
Leva sinistra



Cromato  
Finitura PVD Steel

p. 184  
p. 184

**BLANCO SOLENTA-S Senso**  
Leva destra



Cromato  
Finitura PVD Steel

p. 184  
p. 184

**BLANCO drink.filter EVOL-S II Pro**



Finitura PVD Steel

p. 183

**BLANCO drink.filter EVOL-S II Pro**



Nero Opaco

p. 183

**BLANCO ELOSCOPE-F**



Cromato

p. 220

**BLANCO TIVO-F**



Cromato



p. 221

**BLANCO TIVO-S-F**



Cromato



p. 221

**BLANCO LANORA-F**



Acciaio massiccio  
spazzolato



p. 222

**BLANCO LANORA-S-F**



Acciaio massiccio  
spazzolato



p. 222

**BLANCO LINUS-F**



Cromato



p. 223

**BLANCO LINUS-S-F**



Cromato



p. 223

**BLANCO CORESSA-F**  
Leva destra



Cromato



p. 224

**BLANCO CORESSA-F**  
Leva sinistra



Cromato



p. 224

**BLANCO LARESSA-F**  
Leva destra



Cromato



p. 224

**BLANCO LARESSA-F**  
Leva sinistra



Cromato



p. 224

**BLANCO DARAS-F**



Cromato



p. 225

**BLANCO DARAS-S-F**



Cromato



p. 225

**BLANCO PANERA-S**



Acciaio massiccio  
spazzolato



p. 185

**BLANCO CULINA-S Duo**



Acciaio massiccio  
satinato opaco



p. 186

**BLANCO LINEE**



Acciaio massiccio  
satinato opaco

p. 189

**BLANCO LINEE-S**



Acciaio massiccio  
satinato opaco



p. 189

**BLANCO LINUS**



Acciaio massiccio  
spazzolato

p. 206

**BLANCO LINUS-S**



Acciaio massiccio  
spazzolato

p. 206

**BLANCO SONEA-S Flexo**



Acciaio massiccio  
spazzolato



p. 192

**BLANCO VONDA**



Acciaio massiccio  
spazzolato

p. 190

**BLANCO AMBIS**



Acciaio massiccio  
spazzolato

p. 207

**BLANCO AMBIS-S**



Acciaio massiccio  
spazzolato

p. 207

**BLANCO LANORA**



Acciaio massiccio  
spazzolato

p. 209

**BLANCO LANORA-S**



Acciaio massiccio  
spazzolato

p. 222

**BLANCO CANDOR**



Acciaio massiccio  
spazzolato

p. 208

eroga la quantità di acqua desiderata

sistema filtrante

versione con sensore di movimento

doccetta estraibile

doccetta estraibile con variazione del getto

leva a sinistra

installazione sottofinestra

connessione elettrica

# Miscelatori

PANORAMICA  
PRODOTTI

## BLANCO CANDOR-S



Acciaio massiccio  
spazzolato



p. 208

## BLANCO JANDORA



Acciaio massiccio  
spazzolato



p. 210

## BLANCO JANDORA-S



Acciaio massiccio  
spazzolato



p. 210

## BLANCO AVONA



Cromato

p. 193

## BLANCO AVONA-S



Cromato

p. 193

## BLANCO AVONA-S



finitura SILGRANIT

p. 193

**NUOVO**



## BLANCO CULINA-S Duo



Cromato

p. 186



## BLANCO CULINA-S



Cromato  
Effetto inox



p. 187  
p. 187

## BLANCO CULINA-S Mini



Cromato  
Effetto inox



p. 187  
p. 187

## BLANCO LIVIA-S



Cromato

p. 191



## BLANCO LIVIA-S



Ottone satinato  
Finitura PVD manganese



p. 191

## BLANCO LIVIA-S Satin Gold



Satin Gold



p. 191

**NUOVO**

## BLANCO LINEE



Cromato

p. 188

## BLANCO LINEE-S



Cromato

p. 188



## BLANCO FONTAS II Satin Gold



Satin Gold

p. 200

**NUOVO**



## BLANCO FONTAS-S II Satin Gold



Satin Gold

p. 200



## BLANCO FONTAS II Nero Opaco



Nero Opaco

p. 197



**NUOVO**

## BLANCO FONTAS-S II Nero Opaco



Nero Opaco

p. 197



## BLANCO FONTAS II



Cromato  
Finitura PVD Steel

p. 198  
p. 198



## BLANCO FONTAS II



finitura SILGRANIT

p. 198



## BLANCO FONTAS-S II



Cromato  
Finitura PVD Steel

p. 198  
p. 198



## BLANCO FONTAS-S II



finitura SILGRANIT

p. 199



## BLANCO ALTA Compact



Cromato

p. 194

## BLANCO ALTA Compact



finitura SILGRANIT

p. 194

## BLANCO ALTA-S Compact



Cromato

p. 194



## BLANCO ALTA-S Compact



finitura SILGRANIT

p. 194



## BLANCO CATRIS-S



Cromato

p. 195



## BLANCO CATRIS-S Flexo



Cromato  
Finitura PVD Steel

p. 195  
p. 195



## BLANCO CATRIS-S Flexo Nero Opaco



Nero Opaco

p. 196



## BLANCO VONDA



Cromato

p. 190

## BLANCO LINUS Nero Opaco



Nero Opaco

p. 204

**NUOVO**



## BLANCO LINUS-S Nero Opaco



Nero Opaco

p. 204

**NUOVO**



## BLANCO LINUS Satin Gold



Satin Gold

p. 205

**NUOVO**

## BLANCO LINUS-S Satin Gold



Satin Gold

p. 205

**NUOVO**



eroga la quantità  
di acqua desiderata

sistema filtrante

versione con sensore  
di movimento

doccetta estraibile

doccetta estraibile  
con variazione del getto

leva a sinistra

installazione  
sottofinestra

connessione  
elettrica



## Miscelatori

BLANCO LINUS



Cromato  
Finitura PVD Steel

p. 203  
p. 203

BLANCO LINUS



finitura SILGRANIT

p. 203

BLANCO LINUS-S



Cromato  
Finitura PVD Steel

  
p. 203  
p. 203

BLANCO LINUS-S



finitura SILGRANIT

  
p. 203

BLANCO TRIMA



Cromato

NUOVO



p. 213

BLANCO TRIMA  
Satin Gold



Satin Gold

NUOVO



p. 213

BLANCO JURENA



Cromato

p. 202

BLANCO JURENA-S



Cromato



p. 210

BLANCO CARENA



Cromato

p. 201

BLANCO CARENA-S



Cromato



p. 201

BLANCO TIVO



Cromato

p. 211

BLANCO TIVO-S



Cromato

p. 211

BLANCO TIVO-S



finitura SILGRANIT



p. 211

BLANCO ANTAS



Cromato

p. 212

BLANCO ANTAS-S



Cromato



p. 212

BLANCO DARAS



Cromato

p. 219

BLANCO DARAS-S



Cromato

p. 219

BLANCO DARAS-S



finitura SILGRANIT



p. 219

BLANCO MILA



Cromato

p. 216

BLANCO MILA-S



Cromato



p. 216

BLANCO MILI



Cromato

p. 218

BLANCO MILI



finitura SILGRANIT

p. 218

BLANCO MILI  
Nero opaco



finitura SILGRANIT

p. 218

BLANCO MIDA  
Nero opaco



Nero Opaco

NUOVO

p. 215

BLANCO MIDA-S  
Nero opaco



Nero Opaco

NUOVO



p. 215

BLANCO MIDA



Cromato

p. 214

BLANCO MIDA



finitura SILGRANIT

p. 214

BLANCO MIDA-S



Cromato



p. 214

BLANCO MIDA-S



finitura SILGRANIT



p. 214

 eroga la quantità di acqua desiderata

 sistema filtrante

 versione con sensore di movimento

 doccetta estraibile

 doccetta estraibile con variazione del getto

 leva a sinistra

 installazione sottofinestra

 connessione elettrica

## Dispenser di sapone

### BLANCO LATO



Cromato  
Finitura PVD Steel

p. 229  
p. 229

### BLANCO LATO



finitura SILGRANIT

p. 230

### BLANCO LATO Satin Gold

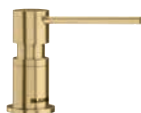

Satin Gold

NUOVO

p. 230

### BLANCO LATO Nero Opaco



Nero Opaco

p. 229

### BLANCO LIVIA



Cromato

p. 232

### BLANCO LIVIA



Grigio manganese

p. 228

### BLANCO LIVIA

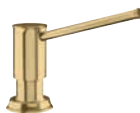

Satin Gold

p. 228

### BLANCO PIONA



Cromato

p. 226

### BLANCO PIONA



Acciaio massiccio  
satinato opaco

NUOVO

p. 226

### BLANCO YANO



Cromato

p. 226

### BLANCO TIGA



Cromato

p. 226

### BLANCO TANGO



Cromato

p. 226

### BLANCO TORRE



Cromato  
Effetto inox

p. 227  
p. 227

### BLANCO TORRE Satin Gold



Satin Gold

NUOVO

p. 227

## Dissipatori di rifiuti

### FWD Max



NUOVO



p. 247

### FWD Medium



NUOVO



p. 248

### FWD Lite



NUOVO



p. 249



eroga la quantità  
di acqua desiderata



sistema filtrante



versione con sensore  
di movimento



doccetta estraibile



doccetta estraibile  
con variazione del getto



leva a sinistra



installazione  
sottofinestra



connessione  
elettrica

## Sistemi per raccolta differenziata

BLANCO SOLON-IF



p. 242

BLANCO SELECT II 60/2 Orga



NUOVO



p. 234

BLANCO SELECT II 60/3 Orga



NUOVO



p. 234

BLANCO SELECT II XL 60/3 Orga



NUOVO



p. 234

BLANCO SELECT II 60/4 Orga



NUOVO



p. 234

BLANCO SELECT II 45/2



NUOVO



p. 235

BLANCO SELECT II 60/2



NUOVO



p. 235

BLANCO SELECT II 60/3



NUOVO



p. 235

BLANCO SELECT II XL 60/3



NUOVO



p. 235

BLANCO SELECT II 60/4



NUOVO



p. 235

BLANCO FLEXON II Low 60/2



NUOVO



p. 239

BLANCO FLEXON II Low 60/3



NUOVO



p. 239

BLANCO FLEXON II Low XL 60/3



NUOVO



p. 239

BLANCO FLEXON II Low 60/4



NUOVO



p. 239

BLANCO FLEXON II Low 90/4



NUOVO



p. 239

BLANCO FLEXON II 60/2



NUOVO



p. 238

BLANCO FLEXON II 60/3



NUOVO



p. 238

BLANCO FLEXON II XL 60/3



NUOVO



p. 238

BLANCO FLEXON II 60/4



NUOVO



p. 238

BLANCO FLEXON II 30/1



NUOVO



p. 237

BLANCO FLEXON II 30/2



NUOVO



p. 237

BLANCO FLEXON II 45/2



NUOVO



p. 237

BLANCO BOTTON Pro 45/2 Automatica



p. 241

BLANCO BOTTON Pro 60/3 Automatica



p. 241

BLANCO BOTTON Pro 45/2 Manuale



p. 240

BLANCO BOTTON Pro 60/3 Manuale



p. 240

BLANCO SINGOLO XL



NUOVO



p. 243

 numero dei secchi

# BELLISSIMO. FORTE. PULITO.

Vasche e lavelli in SILGRANIT®



VASCHE  
SILGRANIT

**Le vasche e i lavelli in Silgranit® sono apprezzati in tutto il mondo per lo stile, il design e l'ampia gamma di colori.**

La cucina è diventata il punto focale delle nostre case e un riflesso del nostro stile di vita. Grazie all'ampia gamma di colori e al design pluripremiato, è possibile trovare il lavello o la vasca giusta in Silgranit per realizzare la cucina dei propri sogni.



Grazie alla combinazione di una superficie straordinariamente resistente e di facile manutenzione, un lavello in Silgranit è la scelta migliore per una cucina durevole nel tempo.



Il Silgranit è l'eroe nella tua cucina. La sua superficie è adatta al contatto con gli alimenti e impermeabile. Inoltre, la formula protettiva brevettata **Hygiene + Plus** riduce la proliferazione batterica mediamente del 98%. Una vasca o un lavello in Silgranit semplifica ogni giorno la vita in cucina.

**Regolari controlli di qualità interni nella produzione delle vasche e dei lavelli in Silgranit confermano gli elevati standard che BLANCO si è prefissata e assicurano prodotti sui quali fare pieno affidamento.**



# COLORI STRAORDINARI.

VASCHE  
SILGRANIT



## Scopri la bellissima gamma di colori SILGRANIT®.

La superficie vellutata di Silgranit è disponibile in una gamma di colori orientati al design e duraturi nel tempo. Il colore è una parte così importante della nostra vita, specialmente all'interno delle nostre case. È un aspetto fondamentale dell'interior design; il colore è infatti una forma di espressione creativa. Esso ha il potere di elevare, energizzare, lenire e risvegliare.

Lasciati ispirare e crea una cucina bellissima - la tua - con i colori Silgranit, disponibili per vasche, lavelli e miscelatori.



nero



antracite



grigio roccia



grigio vulcano

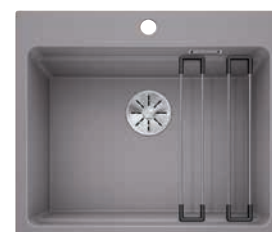

alumetallic



bianco



soft white



tartufo

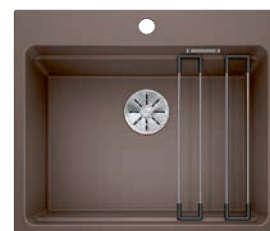

caffé

# NUOVI, AVVOLGENTI COLORI SILGRANIT®.



VASCHE  
SILGRANIT

## Momenti di gioia con colori caldi.

È l'ultima tendenza nel design della cucina: colori caldi e neutri. I colori Silgranit Grigio Vulcano e Soft White creano un'atmosfera calda e sono particolarmente facili da abbinare alle altre tonalità in cucina. Colori rilassanti e accattivanti aprono la strada a momenti rilassanti. E grazie all'ampia gamma di lavelli e miscelatori BLANCO nei colori Silgranit, creare una cucina da sogno è semplicissimo.

NUOVO

Con le vasche e i lavelli Soft White puoi concentrarti sull'essenziale. Il nuovo colore Silgranit Soft White abbinato ai miscelatori in Satin Gold assicura una lussuosa armonia.

NUOVO

Vasche e lavelli nel nuovo colore Silgranit Grigio Vulcano e i funzionali miscelatori abbinati nello stesso colore creano una cucina da sogno, moderna e accattivante. Silgranit Grigio Vulcano si abbinano armoniosamente ai miscelatori Nero Opaco.



## Una dichiarazione di stile in cucina.

La coordinazione dei colori di miscelatore e lavello rende ogni BLANCO UNIT unica. I miscelatori in finitura Silgranit si abbinano ai lavelli in Silgranit in modo coordinato. I miscelatori in Satin Gold e Nero Opaco creano accenti particolarmente armoniosi e conferiscono alla cucina un tocco speciale, con BLANCO UNIT nel cuore della cucina.



# BLANCO ETAGON

Puro ingegno: il lavello a livelli  
Maggiore comfort  
grazie all'eccezionale funzionalità.

Tipologia  
di incasso:



VASCHE  
SILGRANIT



Questo nuovo concetto di lavelli funzionali di BLANCO, trasforma la vasca in centro di lavoro multifunzionale. Il gradino integrato permette di lavorare su 3 diversi livelli contemporaneamente: il piano di lavoro, il gradino della vasca e la vasca stessa. L'affidabilità del materiale, la perfezione estetica e la dotazione di serie (troppopieno rettangolare, scarico InFino e barre inox) innalzano la serie BLANCO ETAGON a livelli ineguagliabili.



## COLORI DISPONIBILI PER BLANCO ETAGON:



3 Livelli funzionali per ottimizzare al massimo il tempo di preparazione, grazie alla perfetta interazione tra il gradino integrato nella vasca, le barre inox in dotazione e gli accessori opzionali.

ATTENZIONE! Le tonalità dei colori sono puramente indicative; per gli abbinamenti, usare SOLO le tabelle colori, disponibili a richiesta.

# BLANCO ETAGON 700-U SILGRANIT

## Un lavello, tre livelli.











- BLANCO ETAGON sfoggia maggiore funzionalità grazie alla sua vasca ancora più ampia
- Comfort ed eleganza grazie allo scarico InFino e al troppopieno rettangolare
- Barre in acciaio inox in dotazione
- Compatibile con kit InFino Total Black

Scarico InFino  
manuale integrato  
di serie



VASCHE  
SILGRANIT



BLANCO ETAGON 700-U Silgranit	Incasso	Dettagli Colore / Finitura	Codice	Euro
	 Sottotop	Nero	1525891	851,00
		Antracite	1525167	851,00
		Grigio Roccia	1525168	851,00
		Alumetallic	1525169	851,00
 <b>NUOVO</b>		Grigio Vulcano	1527261	851,00
		Bianco	1525171	851,00
 <b>NUOVO</b>		Soft White	1527078	851,00
		Tartufo	1525174	851,00
		Caffè	1525176	851,00

**80** cm base  
sottolavello

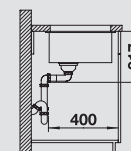
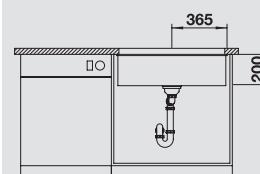
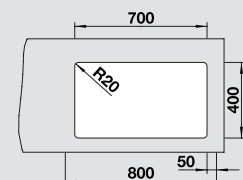
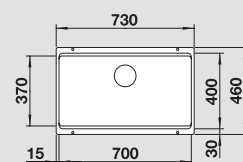

Dimensioni intaglio: 700x400 mm - R 20  
Profondità vasca: 200 mm

**Fornitura:** vasca con piletta da 3½", tappo a cestello InFino, kit di montaggio, coppia di barre in acciaio inox e sifone

Per il passaggio da scarico InFino manuale a scarico InFino a saltarello, è necessaria la sostituzione della piletta (v. pag. 287 - Cod. 1232459)

I lavelli contrassegnati con il simbolo  non possono essere montati a "inizio/fine composizione" nella base sottolavello indicata; possono essere invece facilmente inseriti in una base di misura superiore.

ATTENZIONE! Le tonalità dei colori sono puramente indicative; per gli abbinamenti, usare SOLO le tabelle colori, disponibili a richiesta.

## BLANCO UNIT con BLANCO ETAGON 700-U

### Accessori opzionali

Miscelatore  
BLANCO LINUS-S



Cod. 1526148  
Euro 488,00

Raccolta differenziata  
BLANCO FLEXON II 60/2



Cod. 1521471  
Euro 295,00

Kit BLANCO InFino  
Total Black



Cod. 1239975  
Euro 171,00

**NUOVO**

Barre ETAGON  
in acciaio inox



COMPRESO

Tagliere  
in legno multistrato



Cod. 1230700  
Euro 352,00

Vaschetta forata  
in acciaio inox



Cod. 1227689  
Euro 147,00





# BLANCO ETAGON 500-U SILGRANIT

## Un lavello, tre livelli.

- BLANCO ETAGON sfoggia la funzionalità di un'area di lavaggio dal minimo ingombro
- Lo spazioso lavello monovasca è in grado di contenere comodamente le teglie da forno, che possono essere così tenute a bagno e lavate con facilità
- Barre in acciaio inox in dotazione
- Compatibile con kit InFino Total Black

Scarico InFino  
manuale integrato  
di serie



BLANCO ETAGON 500-U Silgranit	Incasso	Dettagli Colore / Finitura	Codice	Euro
	 Sottotop	Nero	1525887	760,00
		Antracite	1522227	760,00
		Grigio Roccia	1522228	760,00
		Alumetallic	1522229	760,00
		Grigio Vulcano	1527258	760,00
		Bianco	1522231	760,00
		Soft White	1527075	760,00
		Tartufo	1522234	760,00
		Caffè	1522236	760,00

**60** cm base  
sottolavello

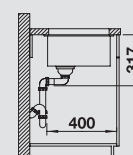
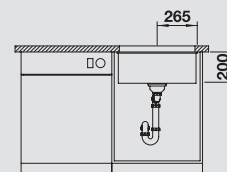
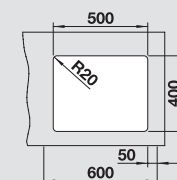
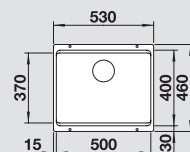

Dimensioni intaglio: 500x400 mm - R 20  
Profondità vasca: 200 mm

**Fornitura:** vasca con pileta da 3½", tappo a cestello InFino, kit di montaggio, coppia di barre in acciaio inox e sifone

Per il passaggio da scarico InFino manuale a scarico InFino a saltarello, è necessaria la sostituzione della pileta (v. pag. 287 - Cod. 1232459)

I lavelli contrassegnati con il simbolo non possono essere montati a "inizio/fine composizione" nella base sottolavello indicata; possono essere invece facilmente inseriti in una base di misura superiore.

ATTENZIONE! Le tonalità dei colori sono puramente indicative; per gli abbinamenti, usare SOLO le tabelle colori, disponibili a richiesta.

### BLANCO UNIT con BLANCO ETAGON 500-U

### Accessori opzionali

#### BLANCO CUCINA-S Mini



Cod. 1519843  
Euro 868,00

#### BLANCO BOTTON Pro 45/2 Automatica



Cod. 1517468  
Euro 255,00

#### Barre ETAGON in acciaio inox



COMPRESO

#### Tagliere in legno multistrato



Cod. 1230700  
Euro 352,00

#### Tagliere in cristallo satinato silver



Cod. 1227697  
Euro 205,00

#### Cestello inox multifunzione



Cod. 1223297  
Euro 215,00

# BLANCO ETAGON 8 SILGRANIT

Un lavello, tre livelli.

- BLANCO ETAGON 8 con fascia miscelatore, su cui è possibile installare il dispenser di sapone e il comando saltarello
- Il gradino integrato aumenta la praticità e il comfort di utilizzo
- Barre in acciaio inox in dotazione
- Compatibile con kit InFino Total Black



Scarico InFino  
manuale integrato  
di serie



VASCHE  
SILGRANIT

BLANCO ETAGON 8 Silgranit	Incasso	Dettagli Colore / Finitura	Codice	Euro
	 Sopratop	Nero	1525893	975,00
		Antracite	1525187	975,00
		Grigio Roccia	1525188	975,00
		Alumetallic	1525189	975,00
		Grigio Vulcano	1527262	975,00
		Bianco	1525191	975,00
		Soft White	1527079	975,00
		Tartufo	1525194	975,00
		Caffè	1525196	975,00

80 cm base  
sottolavello

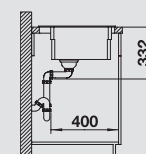
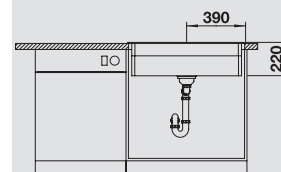
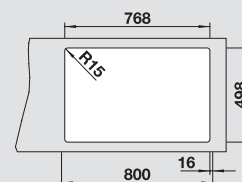
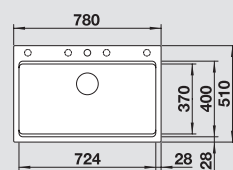

Dimensioni intaglio: 768x498 mm - R 15  
Profondità vasca: 220 mm

**Fornitura:** vasca con piletta da 3½", tappo a cestello InFino, coppia di barre in acciaio inox e sifone

Per il passaggio da scarico InFino manuale a scarico InFino a saltarello, è necessaria la sostituzione della piletta (v. pag. 287 - Cod. 1232459)

I lavelli contrassegnati con il simbolo non possono essere montati a "inizio/fine composizione" nella base sottolavello indicata; possono essere invece facilmente inseriti in una base di misura superiore.

ATTENZIONE! Le tonalità dei colori sono puramente indicative; per gli abbinamenti, usare SOLO le tabelle colori, disponibili a richiesta.

## BLANCO UNIT con BLANCO ETAGON 8

## Accessori opzionali

Miscelatore  
BLANCO LINUS-S



Cod. 1526148  
Euro 488,00

BLANCO SELECT Orga  
60/3



Cod. 1526209  
Euro 703,00

Dissipatore BLANCO  
FWD Max



Cod. 1526648  
Euro 1.248,00

NUOVO

Barre ETAGON  
in acciaio inox



COMPRESO

Kit BLANCO InFino  
Total Black



Cod. 1239975  
Euro 171,00

NUOVO

Tagliere  
in legno multistrato



Cod. 1230700  
Euro 352,00



# BLANCO ETAGON 6

SILGRANIT

## Un lavello, tre livelli.

- BLANCO ETAGON 6 con fascia miscelatore, su cui è possibile installare il dispenser di sapone e il comando saltarello (opzionali)
- Installazione sopratop con bordo estremamente basso
- Barre in acciaio inox in dotazione
- Compatibile con kit InFino Total Black

Scarico InFino  
manuale integrato  
di serie



**60** cm base  
sottolavello

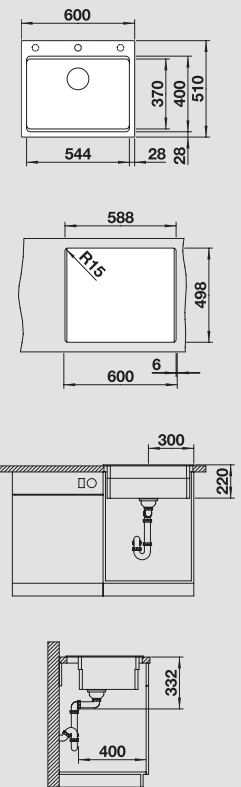

BLANCO ETAGON 6 Silgranit	Incasso	Dettagli Colore / Finitura	Codice	Euro
	 Sopratop	Nero	1525890	851,00
		Antracite	1524539	851,00
		Grigio Roccia	1524540	851,00
		Alumetallic	1524541	851,00
<b>NUOVO</b>		Grigio Vulcano	1527259	851,00
		Bianco	1524543	851,00
<b>NUOVO</b>		Soft White	1527076	851,00
		Tartufo	1524546	851,00
		Caffè	1524548	851,00

Dimensioni intaglio: 588x498 mm - R 15  
Profondità vasca: 220 mm

**Fornitura:** vasca con piletta da 3½", tappo a cestello InFino, coppia di barre in acciaio inox e sifone

Per il passaggio da scarico InFino manuale a scarico InFino a saltarello, è necessaria la sostituzione della piletta (v. pag. 287 - Cod. 1232459)

I lavelli contrassegnati con il simbolo non possono essere montati a "inizio/fine composizione" nella base sottolavello indicata; possono essere invece facilmente inseriti in una base di misura superiore.

ATTENZIONE! Le tonalità dei colori sono puramente indicative; per gli abbinamenti, usare SOLO le tabelle colori, disponibili a richiesta.

### BLANCO UNIT con BLANCO ETAGON 6

### Accessori opzionali

Miscelatore  
BLANCO LINUS-S



Cod. 1526148  
Euro 488,00

Raccolta differenziata  
BLANCO SELECT Orga 60/3



Cod. 1526209  
Euro 703,00

Gocciolatoio  
sintetico nero

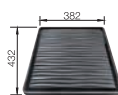

Cod. 1230734  
Euro 85,00

Kit BLANCO InFino  
Total Black



Cod. 1239975  
Euro 171,00

Barre ETAGON  
in acciaio inox



COMPRESO

Tagliere  
in legno multistrato

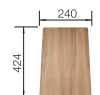

Cod. 1230700  
Euro 352,00



# BLANCO ETAGON 6 Black Edition

**NUOVO**

SILGRANIT

- Soluzione estetica dalla massima raffinatezza
- Tutti gli elementi funzionali (pop-up, troppopieno e scarico InFino) sono in colore Nero Opaco
- Ampia vasca multilivello altamente funzionale: il gradino integrato fornisce un livello di lavoro extra grazie alle barre inox in dotazione

Scarico InFino  
manuale integrato  
di serie



VASCHE  
SILGRANIT

BLANCO ETAGON 6 Black Edition  
Silgranit

**NUOVO**



Incasso



Sopratop

Dettagli  
Colore / Finitura

Nero Black Edition

Codice

1526339

Euro

999,00

**60** cm base  
sottolavello

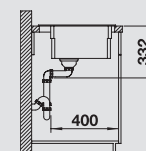
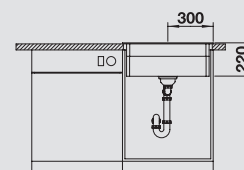
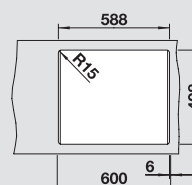
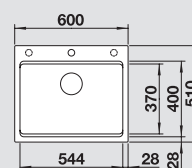

Dimensioni intaglio: 588x498 mm - R 15  
Profondità vasca: 220 mm

**Fornitura:** vasca con pileta da 3½", tappo a cestello InFino, coppia di barre in acciaio inox, comando saltarello COMFORT e sifone

Per il passaggio da scarico InFino manuale a scarico InFino a saltarello, è necessaria la sostituzione della pileta (v. pag. 287 - Cod. 1232459)

I lavelli contrassegnati con il simbolo  non possono essere montati a "inizio/fine composizione" nella base sottolavello indicata; possono essere invece facilmente inseriti in una base di misura superiore.

ATTENZIONE! Le tonalità dei colori sono puramente indicative; per gli abbinamenti, usare SOLO le tabelle colori, disponibili a richiesta.

## BLANCO UNIT con BLANCO ETAGON 6

## Accessori opzionali

Miscelatore  
BLANCO LINUS-S



Cod. 1526148  
Euro 488,00

Raccolta differenziata  
BLANCO SELECT Orga 60/3



Cod. 1526209  
Euro 703,00

Dissipatore BLANCO  
FWD Max



Cod. 1526648  
Euro 1.248,00

**NUOVO**

Barre ETAGON  
in acciaio inox



COMPRESO

Gocciolatoio  
sintetico nero

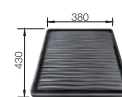

Cod. 1230734  
Euro 85,00

Tagliere  
in legno multistrato



Cod. 1230700  
Euro 352,00



# BLANCO SUBLINE -U, -F

Fascino e design in 10 colori

VASCHE  
SILGRANIT



Lavello: BLANCO SUBLINE 500-U, con kit scarico Total Black

Miscelatore: BLANCO CATRIS-S, Nero Opaco



BLANCO SUBLINE 160-U



BLANCO SUBLINE 320-U



BLANCO SUBLINE 400-U



BLANCO SUBLINE 500-U



BLANCO SUBLINE 700-U



BLANCO SUBLINE 700-U Level



BLANCO SUBLINE 320-F



BLANCO SUBLINE 400-F



BLANCO SUBLINE 500-F

Mostrato nel colore:  
**Grigio Vulcano**





Le vasche BLANCO SUBLINE -U e -F in Silgranit sono disponibili con l'esclusivo sistema di montaggio **Easymount**: i fori già presenti sui bordi delle vasche agevolano le operazioni di installazione.

Tutti i modelli sono disponibili nei colori Silgranit, completi di pratici accessori, e dotati di un **raggio interno da 10 mm** che unisce perfettamente design e funzionalità.



Le vasche BLANCO SUBLINE possono contare su un'ampia gamma di accessori opzionali disponibili.



La versione -F, per incasso a filotop, completa la famiglia di vasche sottotop BLANCO SUBLINE in Silgranit.

**COLORI DISPONIBILI PER BLANCO SUBLINE:**

**COLORI DISPONIBILI PER BLANCO SUBLINE:**

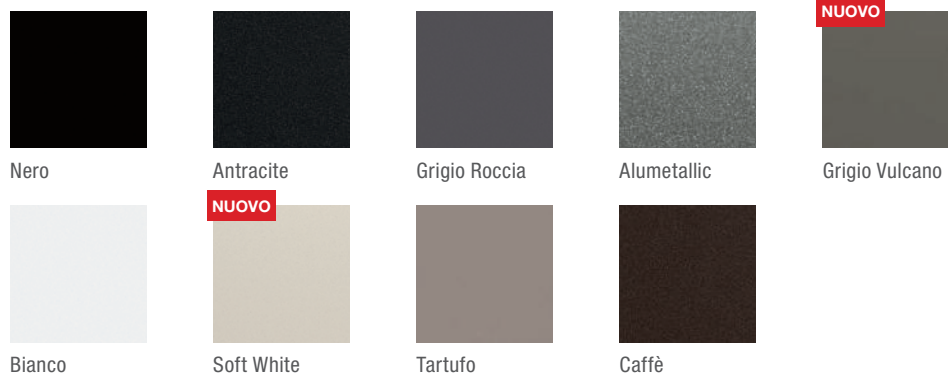

BLANCO SUBLINE 340/160-U



BLANCO SUBLINE 800-U



BLANCO SUBLINE 350/350-U



BLANCO SUBLINE 430/270-U



BLANCO SUBLINE 480/320-U







BLANCO SUBLINE 340/160-F



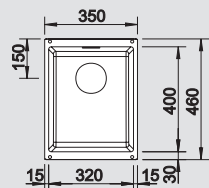

ATTENZIONE! Le tonalità dei colori sono puramente indicative; per gli abbinamenti, usare SOLO le tabelle colori, disponibili a richiesta.

**Tipologia di incasso:**

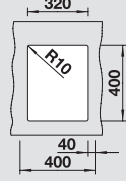



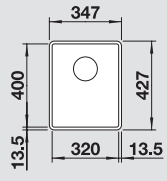



BLANCO SUBLINE 160-U Silgranit	Incasso	Dettagli Colore / Finitura	Codice	Euro	30 cm base sottolavello
	 Sottotop	Nero	1525981	555,00	
		Antracite	1513399	555,00	
<b>Accessori idonei</b> 1		Grigio Roccia	1518951	555,00	
		Alumetallic	1513400	555,00	
		Grigio Vulcano <b>NUOVO</b>	1526799	555,00	
		Bianco	1513394	555,00	
		Soft White <b>NUOVO</b>	1526802	555,00	
		Tartufo	1517425	555,00	
		Caffè	1515051	555,00	
		<p>Dimensioni intaglio: 160x400 mm - R 10                      Profondità vasca: 130 mm</p> <p><b>Fornitura:</b> vasca con piletta da 3½", tappo a cestello InFinO, kit di montaggio e sifone</p>			

BLANCO SUBLINE 320 Silgranit	Incasso	Dettagli Colore / Finitura	Codice	Euro	40 cm base sottolavello
	 Sottotop	<b>BLANCO SUBLINE 320-U</b>			
		Nero	1525983	572,00	
<b>Accessori idonei</b> 1 2 3 4 5		Antracite	1518546	572,00	
		Grigio Roccia	1518953	572,00	
		Alumetallic	1518547	572,00	
		Grigio Vulcano <b>NUOVO</b>	1527343	572,00	
		Bianco	1518549	572,00	
		Soft White <b>NUOVO</b>	1527160	572,00	
		Tartufo	1518553	572,00	
		Caffè	1518554	572,00	
<p>Dimensioni intaglio: 320x400 mm - R 10                      Profondità vasca: 190 mm</p> <p><b>Fornitura:</b> vasca con piletta da 3½", tappo a cestello InFinO, kit di montaggio e sifone</p>					

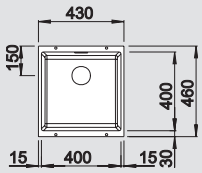
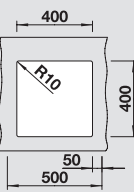
	Incasso filotop	Dettagli Colore / Finitura	Codice	Euro	
	 Incasso filotop	<b>BLANCO SUBLINE 320-F</b>			
		Nero	1525982	726,00	
<b>Accessori idonei</b> 1 2 3 4 5		Antracite	1519790	726,00	
		Grigio Roccia	1519791	726,00	
		Alumetallic	1519792	726,00	
		Grigio Vulcano <b>NUOVO</b>	1527342	726,00	
		Bianco	1519793	726,00	
		Soft White <b>NUOVO</b>	1527159	726,00	
		Caffè	1519795	726,00	
		<p>Profondità vasca: 190 mm</p> <p><b>Fornitura:</b> vasca con piletta da 3½", tappo a cestello InFinO e sifone</p>			

BLANCO UNIT con BLANCO SUBLINE -U e -F					Accessori opzionali	
<b>Miscelatore BLANCO LINEE</b>	<b>Miscelatore BLANCO TIVO-S</b>	<b>Raccolta differenziata BLANCO FLEXON II 60/2</b>	<b>Dissipatore FWD Medium</b> <b>NUOVO</b>	<b>Kit scarico singolo Total Black</b> <b>NUOVO</b>	<b>Kit scarico doppio Total Black</b> <b>NUOVO</b>	
						
Cod. 1517594 Euro 635,00	Cod. 1526976 Euro 679,00	Cod. 1521471 Euro 295,00	Cod. 1526647 Euro 965,00	Cod. 1239975 Euro 181,00	Cod. 1239979 Euro 284,00	

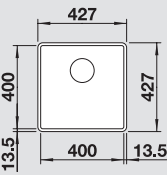
BLANCO SUBLINE 400 Silgranit	Incasso	Dettagli Colore / Finitura	Codice	Euro	50 cm base sottolavello
 <p><b>Accessori idonei</b></p> <p>1 2 3 4 5</p>  Scarico InFinO manuale integrato di serie	 <p>Sottotop</p>	<b>BLANCO SUBLINE 400-U</b>			 
		Nero 1525990 589,00 Antracite 1518555 589,00 Grigio Roccia 1518963 589,00 Alumetallic 1518556 589,00 Grigio Vulcano <b>NUOVO</b> 1527349 589,00 Bianco 1518558 589,00 Soft White <b>NUOVO</b> 1527166 589,00 Tartufo 1518562 589,00 Caffè 1518563 589,00			
Dimensioni intaglio: 400x400 mm - R 10 Profondità vasca: 190 mm <b>Fornitura:</b> vasca con piletta da 3½", tappo a cestello InFinO, kit di montaggio e sifone					
 <p><b>Accessori idonei</b></p> <p>1 2 3 4 5</p>  Scarico InFinO manuale integrato di serie	 <p>Incasso filotop</p>	<b>BLANCO SUBLINE 400-F</b>			
		Nero 1525988 760,00 Antracite 1519796 760,00 Grigio Roccia 1519797 760,00 Alumetallic 1519798 760,00 Grigio Vulcano <b>NUOVO</b> 1527348 760,00 Bianco 1519799 760,00 Soft White <b>NUOVO</b> 1527165 760,00 Caffè 1519801 760,00			
Profondità vasca: 190 mm <b>Fornitura:</b> vasca con piletta da 3½", tappo a cestello InFinO e sifone					

VASCHE  
SILGRANIT



BLANCO SUBLINE 400-U

Per il passaggio da scarico InFinO manuale a scarico InFinO a saltarello, è necessaria la sostituzione della piletta (v. pag. 265 - Cod. 1232459)

**Accessori opzionali**

**Vaschetta forata in acciaio inox**



Cod. 1227689  
Euro 147,00

1

**Tagliere in cristallo satinato silver**



Cod. 1227697  
Euro 205,00

2

**Cestello inox multifunzione**



Cod. 1223297  
Euro 215,00

3

**Tagliere in legno multistrato**



Cod. 1230700  
Euro 352,00

4

**Griglia multifunzione in acciaio inox**



Cod. 1234795  
Euro 205,00

5

**Griglia pieghevole multifunzione**



Cod. 1238482  
Euro 181,00

**BLANCO SUBLINE 500  
Silgranit**

**Accessori idonei**

Scarico InFino manuale integrato di serie

**Incasso**
**Dettagli  
Colore / Finitura**
**Codice**
**Euro**



Sottotop

**BLANCO SUBLINE 500-U**

Nero	1525995	606,00
Antracite	1518564	606,00
Grigio Roccia	1518966	606,00
Alumetallic	1518565	606,00
Grigio Vulcano	1527353	606,00
Bianco	1518567	606,00
Soft White	1527170	606,00
Tartufo	1518571	606,00
Caffè	1518572	606,00

 Dimensioni intaglio: 500x400 mm - R 10  
 Profondità vasca: 190 mm

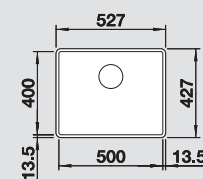
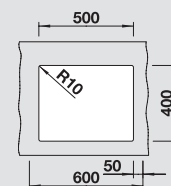
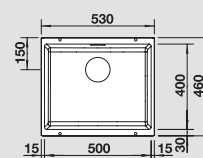
**Fornitura:** vasca con piletta da 3½", tappo a cestello InFino, kit di montaggio e sifone

**60** cm base  
sottolavello

**Accessori idonei**

Scarico InFino manuale integrato di serie

 Incasso  
filotop

**BLANCO SUBLINE 500-F**

Nero	1525994	794,00
Antracite	1519808	794,00
Grigio Roccia	1519809	794,00
Alumetallic	1519811	794,00
Grigio Vulcano	1527352	794,00
Bianco	1519812	794,00
Soft White	1527169	794,00
Caffè	1519814	794,00

Profondità vasca: 190 mm

**Fornitura:** vasca con piletta da 3½", tappo a cestello InFino e sifone

 Per vasca Silgranit 500 con fascia miscelatore,  
 vedere **BLANCO PLEON 5** a pag. 132

**BLANCO SUBLINE 700-U  
Silgranit**

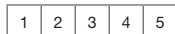
**Accessori idonei**

Scarico InFino manuale integrato di serie

**Incasso**
**Dettagli  
Colore / Finitura**
**Codice**
**Euro**

Sottotop

Nero	1526001	856,00
Antracite	1518573	856,00
Grigio Roccia	1518969	856,00
Alumetallic	1518574	856,00
Grigio Vulcano	1527356	856,00
Bianco	1518576	856,00
Soft White	1527173	856,00
Tartufo	1518580	856,00
Caffè	1518581	856,00

 Dimensioni intaglio: 700x400 mm - R 10  
 Profondità vasca: 190 mm

**Fornitura:** vasca con piletta da 3½", tappo a cestello InFino, kit di montaggio e sifone

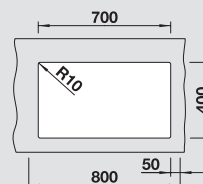
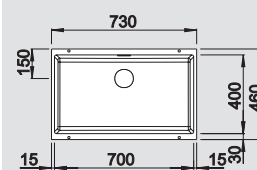
**80** cm base  
sottolavello

 Per vasca Silgranit 700 con fascia miscelatore,  
 vedere **BLANCO PLEON 8** a pag. 133

**BLANCO UNIT con BLANCO SUBLINE -U e -F**
**Accessori opzionali**
**Miscelatore  
BLANCO LINEE**

 Cod. 1517594  
 Euro 635,00

**Miscelatore  
BLANCO TIVO-S**

 Cod. 1526976  
 Euro 679,00

**Raccolta differenziata  
BLANCO FLEXON II 60/2**

 Cod. 1521471  
 Euro 295,00

**Dissipatore  
FWD Medium**

 Cod. 1526647  
 Euro 965,00

**Kit scarico singolo  
Total Black**

 Cod. 1239975  
 Euro 171,00

**Kit scarico doppio  
Total Black**

 Cod. 1239979  
 Euro 301,00



**BLANCO SUBLINE 700-U Level Silgranit**

Incasso	Dettagli Colore / Finitura	Codice	Euro
Sottotop	Nero	1526004	902,00
	Antracite	1518390	902,00
	Grigio Roccia	1518973	902,00
	Alumetallic	1518391	902,00
	Grigio Vulcano <b>NUOVO</b>	1527355	902,00
	Bianco	1518393	902,00
	Soft White <b>NUOVO</b>	1527172	902,00
	Tartufo	1518397	902,00
	Caffè	1518398	902,00

**80** cm base sottolavello

**Accessori idonei**

Scarico InFino manuale integrato di serie

 Dimensioni intaglio: 700x400 mm - R 10  
 Profondità vasca: 200/140 mm

**Fornitura:** vasca con piletta da 3½", tappo a cestello InFino, kit di montaggio e sifone

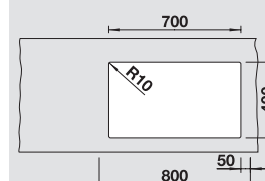
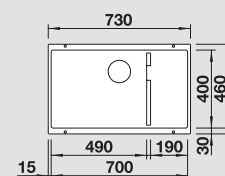
**Colori Champagne e Jasmine non disponibili per questo modello.**

**VASCHE SILGRANIT**
**BLANCO SUBLINE 800-U Silgranit**

Incasso	Dettagli Colore / Finitura	Codice	Euro
Sottotop	Nero	1526005	975,00
	Antracite	1523141	975,00
	Grigio Roccia	1523142	975,00
	Alumetallic	1523143	975,00
	Grigio Vulcano <b>NUOVO</b>	1527357	975,00
	Bianco	1523145	975,00
	Soft White <b>NUOVO</b>	1527174	975,00
	Tartufo	1523148	975,00
	Caffè	1523150	975,00

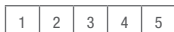
**90** cm base sottolavello

**Accessori idonei**

Scarico InFino manuale integrato di serie

 Dimensioni intaglio: 800x400 mm - R 10  
 Profondità vasca: 220 mm

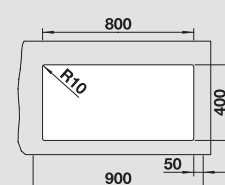
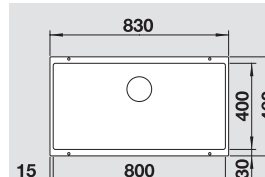
**Fornitura:** vasca con piletta da 3½", tappo a cestello InFino, kit di montaggio e sifone

**BLANCO SUBLINE 700-U**

Per il passaggio da scarico InFino manuale a scarico InFino a saltarello, è necessaria la sostituzione della piletta (v. pag. 265 - Cod. 1232459)

**Accessori opzionali**
**Vaschetta forata in acciaio inox**

 Cod. 1227689  
 Euro 147,00

**1**
**Tagliere in cristallo satinato silver**

 Cod. 1227697  
 Euro 205,00

**2**
**Cestello inox multifunzione**

 Cod. 1223297  
 Euro 215,00

**3**
**Tagliere in legno multistrato**

 Cod. 1230700  
 Euro 352,00

**4**
**Griglia multifunzione in acciaio inox**

 Cod. 1234795  
 Euro 205,00

**5**
**Griglia pieghevole multifunzione**

 Cod. 1238482  
 Euro 181,00

**BLANCO SUBLINE 340/160  
Silgranit**

**Incasso**

**Dettagli  
Colore / Finitura**

**Codice  
Vasca SX**

**Codice  
Vasca DX**

**Euro**

**60** cm base  
sottolavello



**Accessori idonei**



Scarico InFino manuale integrato di serie



Sottotop

**BLANCO SUBLINE 340/160-U**

Nero	1525985	1525986	772,00
Antracite	1513795	1520402	772,00
Grigio Roccia	1518956	1520403	772,00
Alumetallic	1513789	1520404	772,00
Grigio Vulcano <b>NUOVO</b>	1527345	1527346	772,00
Bianco	1513790	1520406	772,00
Soft White <b>NUOVO</b>	1527162	1527163	772,00
Tartufo	1517430	1520409	772,00
Caffè	1515057	1520410	772,00

Dimensioni intaglio: 525x400 mm - R 10  
Profondità vasche: 190/130 mm

**Fornitura:** vasche con piletta da 3½", tappo a cestello InFino, kit di montaggio e sifone

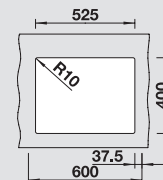
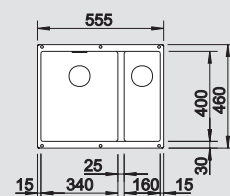

**Accessori idonei**



Scarico InFino manuale integrato di serie



Incasso  
filotop

**BLANCO SUBLINE 340/160-F**

Nero	1525984	902,00
Antracite	1519802	902,00
Grigio Roccia	1519803	902,00
Alumetallic	1519804	902,00
Grigio Vulcano <b>NUOVO</b>	1527344	902,00
Bianco	1519805	902,00
Soft White <b>NUOVO</b>	1527161	902,00
Caffè	1519807	902,00

Profondità vasche: 190/130 mm

**Fornitura:** vasca con piletta da 3½", tappo a cestello InFino e sifone

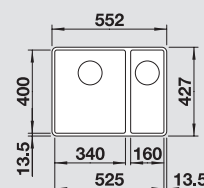

Per vasca Silgranit 340/160 con fascia miscelatore, vedere **BLANCO PLEON 6 Split** a pag. 132



**BLANCO SUBLINE 350/350-U, Alumetallic, con kit scarico doppio Total Black**

**BLANCO UNIT con BLANCO SUBLINE -U e -F**

**Accessori opzionali**

Miscelatore  
**BLANCO LINEE**



Cod. 1517594  
Euro 635,00

Miscelatore  
**BLANCO TIVO-S**



Cod. 1526976  
Euro 679,00

Raccolta differenziata  
**BLANCO FLEXON II 60/2**



Cod. 1521471  
Euro 295,00

Dissipatore  
**FWD Medium**



Cod. 1526647  
Euro 965,00

Kit scarico singolo  
**Total Black**



Cod. 1239975  
Euro 171,00

Kit scarico doppio  
**Total Black**



Cod. 1239979  
Euro 301,00

**BLANCO SUBLINE 350/350-U  
Silgranit**

**Accessori idonei**

Scarico InFino manuale integrato di serie

Incasso	Dettagli Colore / Finitura	Codice	Euro
Sottotop	Nero	1525987	873,00
	Antracite	1518591	873,00
	Grigio Roccia	1518960	873,00
	Alumetallic	1518592	873,00
	Grigio Vulcano <b>NUOVO</b>	1527347	873,00
	Bianco	1518594	873,00
	Soft White <b>NUOVO</b>	1527164	873,00
	Tartufo	1518598	873,00
	Caffè	1518599	873,00

 Dimensioni intaglio: 725x400 mm - R 10  
 Profondità vasche: 200 mm

**Fornitura:** vasche con piletta da 3½", tappo a cestello InFino, kit di montaggio e sifone

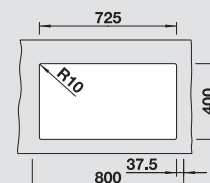
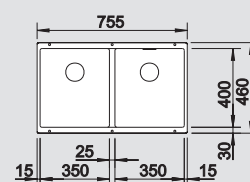
**80** cm base  
sottolavello

**BLANCO SUBLINE 430/270-U  
Silgranit**

**Accessori idonei**

Scarico InFino manuale integrato di serie

Incasso	Dettagli Colore / Finitura	Codice	Euro
Sottotop	Nero	1525991	919,00
	Antracite	1523151	919,00
	Grigio Roccia	1523152	919,00
	Alumetallic	1523153	919,00
	Grigio Vulcano <b>NUOVO</b>	1527350	919,00
	Bianco	1523155	919,00
	Soft White <b>NUOVO</b>	1527167	919,00
	Tartufo	1523158	919,00
	Caffè	1523160	919,00

 Dimensioni intaglio: 725x400 mm - R 10  
 Profondità vasche: 200 mm

**Fornitura:** vasche con piletta da 3½", tappo a cestello InFino, kit di montaggio e sifone

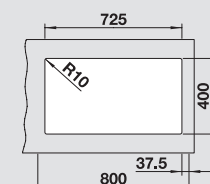
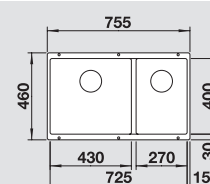
**80** cm base  
sottolavello

**BLANCO SUBLINE 480/320-U  
Silgranit**

**Accessori idonei**

Scarico InFino manuale integrato di serie

Incasso	Dettagli Colore / Finitura	Codice	Euro
Sottotop	Nero	1525993	992,00
	Antracite	1519474	992,00
	Grigio Roccia	1519475	992,00
	Alumetallic	1519476	992,00
	Grigio Vulcano <b>NUOVO</b>	1527351	992,00
	Bianco	1519478	992,00
	Soft White <b>NUOVO</b>	1527168	992,00
	Tartufo	1519482	992,00
	Caffè	1519483	992,00

 Dimensioni intaglio: 825x400 mm - R 10  
 Profondità vasche: 200/200 mm

**Fornitura:** vasche con piletta da 3½", tappo a cestello InFino, kit di montaggio e sifone

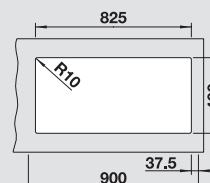
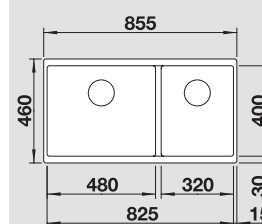
**100** cm base  
sottolavello

Per il passaggio da scarico InFino manuale a scarico InFino a saltarello, è necessaria la sostituzione della piletta (v. pag. 265 - Cod. 1232459)

**Accessori opzionali**
**Vaschetta forata  
in acciaio inox**

 Cod. 1227689  
Euro 147,00

1

**Tagliere  
in cristallo satinato silver**

 Cod. 1227697  
Euro 205,00

2

**Cestello inox  
multifunzione**

 Cod. 1223297  
Euro 215,00

3

**Tagliere  
in legno multistrato**

 Cod. 1230700  
Euro 352,00

4

**Griglia multifunzione  
in acciaio inox**

 Cod. 1234795  
Euro 205,00

5

**Griglia pieghevole  
multifunzione**

 Cod. 1238482  
Euro 181,00

**NUOVO**

# BLANCO SUBLINE 500-U

## Black Edition

SILGRANIT

- Look armoniosamente coordinato per design moderno e attuale
- Tutti gli elementi funzionali (troppopieno e piletta InFino) sono in colore Nero Opaco
- Vasca dal design senza tempo, lineare ed elegante

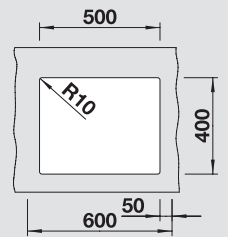
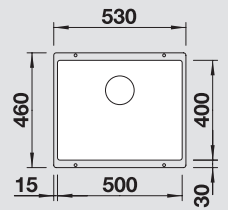
Scarico InFino  
manuale integrato  
di serie**60** cm base  
sottolavelloBLANCO SUBLINE 500-U Black Edition  
Silgranit

Incasso

Dettagli  
Colore / Finitura

Codice

Euro



Sottotop

**Nero Black Edition**

1526340

755,00

Dimensioni intaglio: 500x400 mm - R 10  
Profondità vasca: 190 mm**Fornitura:** vasca con piletta da 3½", tappo a cestello InFino,  
kit di montaggio e sifone

### BLANCO UNIT con SUBLINE 500-U Black edition

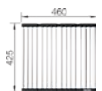
BLANCO CATRIS-S Flexo  
Nero OpacoCod. 1525793  
Euro 782,00Raccolta differenziata  
BLANCO FLEXON II 60/2Cod. 1521471  
Euro 295,00Cestello inox  
multifunzioneCod. 1223297  
Euro 215,00Tagliere  
in legno multistratoCod. 1230700  
Euro 352,00Vaschetta forata  
in acciaio inoxCod. 1227689  
Euro 147,00Griglia pieghevole  
multifunzioneCod. 1238482  
Euro 181,00

### Accessori opzionali



# BLANCO SUBLINE 500-IF BLANCO SUBLINE 500-IF/A SteelFrame

SILGRANIT e acciaio inox

- Innovativo: un mix unico di acciaio inox e Silgranit
- Adatto all'incasso anche su pietra, vetro e laminato
- Larghezza di 500 mm e raggio angolo morbido (R 10 mm)
- Installazione a filotop e sopratop con effetto semifilo



BLANCO SUBLINE 500-IF/A SteelFrame

Scarico InFino  
manuale integrato  
di serie



VASCHE  
SILGRANIT

**BLANCO SUBLINE 500 Steelframe**  
Silgranit e acciaio inox

**Incasso**

**Dettagli**

Colore / Finitura

**Codice**

**Euro**

**60** cm base  
sottolavello



Sopratop  
e filotop

**BLANCO SUBLINE 500-IF**

Nero  
Antracite

1525997

1.305,00

1519430

1.305,00

Dimensioni intaglio sopratop: 532x432 mm - R 10  
Profondità vasca: 190 mm

**Fornitura:** vasca con piletta da 3½", tappo a cestello InFino e sifone

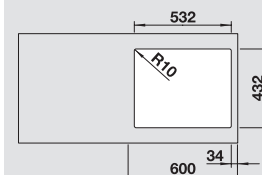
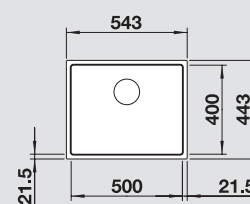

**BLANCO SUBLINE 500 Steelframe**  
Silgranit e acciaio inox

**Incasso**

**Dettagli**

Colore / Finitura

**Codice**

**Euro**

**60** cm base  
sottolavello



Sopratop  
e filotop

**BLANCO SUBLINE 500-IF/A**

Nero  
Antracite  
Bianco

1526000

1.928,00

1520933

1.928,00

1521019

1.928,00

Dimensioni intaglio sopratop: 532x499 mm - R 10  
Profondità vasca: 190 mm

**Fornitura:** vasca con piletta da 3½", tappo a cestello InFino e sifone

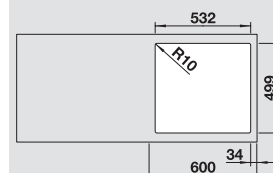
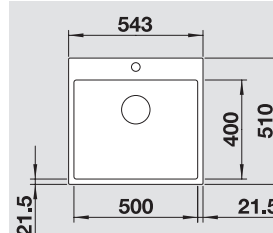

## BLANCO UNIT con SUBLINE 500-IF SteelFrame

## Accessori opzionali

Miscelatore  
BLANCO LINEE



Cod. 1517594  
Euro 635,00

Raccolta differenziata  
BLANCO SELECT II XL 60/3 Orga



Cod. 1526210  
Euro 726,00

Kit scarico singolo  
Total Black



Cod. 1239975  
Euro 171,00

**NUOVO**

Tagliere  
in legno multistrato



Cod. 1230700  
Euro 352,00

Griglia multifunzione  
in acciaio inox



Cod. 1234795  
Euro 205,00

Griglia pieghevole  
multifunzione



Cod. 1238482  
Euro 181,00

# CLASSICO. SENZA TEMPO. ELEGANTE.

Vasche e lavelli in acciaio inox.



I lavelli in acciaio inox sono eleganti e senza tempo, e sono i preferiti dai progettisti di cucine. Oltre alle sue proprietà, idonee per la preparazione del cibo e per lavare i piatti, l'acciaio inossidabile offre anche numerose opzioni di design e caratteristiche, come angoli arrotondati o stretti, diverse profondità della vasca e forma del lavello. Un'ampia gamma di stili apre infinite possibilità per trovare il lavello giusto per ogni cucina, mentre i toni neutri dell'acciaio inox si sposano armoniosamente con qualsiasi ambiente cucina.



L'acciaio inox è igienico, la sua superficie è liscia al tatto, è resistente e privo di pori, il che lo rende eccezionalmente facile da mantenere. La qualità dell'acciaio inossidabile BLANCO rende i nostri lavelli sicuri per l'uso alimentare. Questo materiale ha una naturale resistenza agli acidi di uso domestico (come l'acido acetico o l'acido citrico) e alle macchie dovute, per es. a caffè, tè, o gli acidi della frutta. Puoi preparare il cibo sulla sua superficie in tranquillità.



L'acciaio inox è robusto. I piatti o i vasi che accidentalmente cadono su di esso, non si rompono facilmente. Appoggiare pentole calde o versare acqua bollente nel lavello non influirà sulla sua resistenza al calore. Con la minima cura necessaria, i lavelli in acciaio inossidabile manterranno la loro brillantezza e saranno perfetti per decenni.

# NON SONO SOLO VASCHE.

Le famiglie di vasche in acciaio inox più desiderate.



## ETAGON

### Uno spazio minimo per avere il massimo

Grazie al gradino integrato, le vasche ETAGON offrono su un design intelligente con tre livelli di lavoro, che possono essere sfruttati contemporaneamente. Questo garantisce maggiore praticità ed efficienza, per risultati ottimali in cucina.



## SOLIS

### Vasche in acciaio inox dal design sinuoso.

Le vasche in acciaio inox BLANCO SOLIS si distinguono per il loro armonioso mix di design ed elementi funzionali di alta qualità. Il design moderno, caratterizzato dalla combinazione di un ampio raggio angolare con un raggio di base più stretto, il troppopieno rettangolare e l'elegante sistema di scarico InFino, rendono questa famiglia di vasche assolutamente contemporanea.



## ANDANO

### Sinfonia in acciaio inox

Ciò che distingue questa famiglia di vasche in acciaio inox è la sua esclusività. Questa famiglia di vasche è assolutamente flessibile e pratica, adatta a ogni cucina.



# BLANCO CLARON -U, -IF, -IF/A

Funzionalità a raggio 10 mm



VASCHE  
INOX

La serie di vasche e lavelli **BLANCO CLARON-IF** e **-IF/A**, grazie al bordo perimetrale smussato, risulta estremamente versatile, poiché è incassabile sia sopratop, sia filotop. La gamma comprende anche i modelli **BLANCO CLARON -U** per incasso sottotop. L'esclusivo raggio delle vasche (10 mm) è il perfetto connubio tra design e praticità. La solidità dell'acciaio la perfezione dei dettagli e il nuovo sistema di scarico InFino, esaltano l'eccellenza della linea **BLANCO CLARON**.









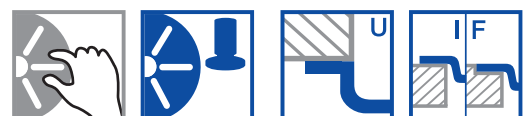

Disponibile in Durinox,  
v. pagg. 70-75

Il bordo smussato e rettificato -IF rappresenta la qualità che da sempre contraddistingue BLANCO nella produzione di vasche e lavelli.

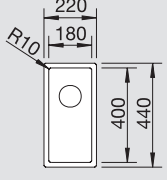



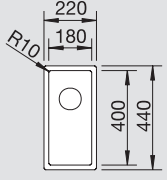



Tipologia  
di incasso:



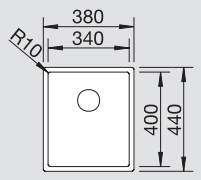

BLANCO CLARON 180 Acciaio Inox 18/10	Incasso	Dettagli Colore / Finitura	Codice	Euro	30 cm base sottolavello
	 Sottotop	<b>BLANCO CLARON 180-U</b> Raggio interno 10 mm	1517209	885,00	
<b>Accessori idonei:</b> 1 2 3 4 5 6 7		Dimensioni intaglio: 180x400 mm - R 10 mm Profondità vasca: 130 mm			
		<b>Fornitura:</b> vasca con piletta da 3½", sifone, tappo a cestello InFino e kit di montaggio			
	 Sopratop bordo 1 mm e filotop	<b>BLANCO CLARON 180-IF</b> Raggio interno/esterno 10 mm	1517208	1.060,00	
<b>Accessori idonei:</b> 1 2 3 4 5 6 7		Dimensioni intaglio per incasso sopratop: 210x430 mm - R 15 Profondità vasca: 130 mm			
		<b>Fornitura:</b> vasca con piletta da 3½", sifone e tappo a cestello InFino			

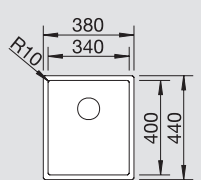
VASCHE  
INOX

BLANCO CLARON 340 Acciaio Inox 18/10	Incasso	Dettagli Colore / Finitura	Codice	Euro	45 cm base sottolavello
	 Sottotop	<b>BLANCO CLARON 340-U</b> Raggio interno 10 mm	1517211	907,00	
<b>Accessori idonei:</b> 2 3 4 5 6 7		Dimensioni intaglio: 340x400 mm - R 10 mm Profondità vasca: 190 mm			
		<b>Fornitura:</b> vasca con piletta da 3½", sifone, tappo a cestello InFino e kit di montaggio			
	 Sopratop bordo 1 mm e filotop	<b>BLANCO CLARON 340-IF</b> Raggio interno/esterno 10 mm	1517210	1.089,00	
<b>Accessori idonei:</b> 2 3 4 5 6 7		Dimensioni intaglio per incasso sopratop: 370x430 mm - R 15 Profondità vasca: 190 mm			
		<b>Fornitura:</b> vasca con piletta da 3½", sifone e tappo a cestello InFino			

 45 cm base  
sottolavello

Per il passaggio da scarico InFino manuale a scarico InFino a saltarello, è necessaria la sostituzione della piletta (v. pag. 265 - Cod. 1232459)

Per i modelli -IF è necessario prevedere uno scanco nello spessore del top per l'alloggiamento del troppopieno (v. pag. 260)

**Nota:** per i modelli con fascia miscelatore è possibile effettuare fori supplementari, previo Vs. disegno esecutivo e nostra approvazione, al costo di Euro 20,00 cad. netto

#### Accessori opzionali

**Vaschetta forata  
in acciaio inox 18/10**



Cod. 1219649  
Euro 448,00

2

**Tagliere in cristallo satinato  
bianco - per gocciolatoio**



Cod. 1225333  
Euro 459,00

3

**Gocciolatoio scorrevole  
in acciaio inox**

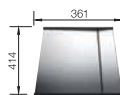

Cod. 1223067  
Euro 555,00

4

**Tagliere massello  
con maniglia inox**



Cod. 1223074  
Euro 647,00

5

**Barre in  
acciaio inox**



Cod. 1235906  
Euro 205,00

6

**Griglia pieghevole  
multifunzione**



Cod. 1238482  
Euro 181,00

7

**BLANCO CLARON 400**  
Acciaio Inox 18/10



**Accessori idonei:**



Scarico InFino manuale integrato di serie

**Incasso**

**Dettagli**  
Colore / Finitura

**Codice**

**Euro**



**BLANCO CLARON 400-U**

Raggio interno 10 mm

1517213

965,00

Sottotop

Dimensioni intaglio: 400x400 mm - R 10  
Profondità vasca: 190 mm

**Fornitura:** vasca con piletta da 3½", sifone, tappo a cestello InFino e kit di montaggio

**60** cm base sottolavello

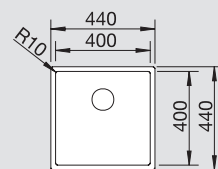

**45** cm base sottolavello

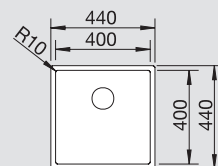

**Accessori idonei:**



Scarico InFino manuale integrato di serie



**BLANCO CLARON 400-IF**

Raggio interno/esterno 10 mm

1517212

1.146,00

Sopratop bordo 1 mm e filotop

Dimensioni intaglio per incasso sopratop: 430x430 mm - R 15  
Profondità vasca: 190 mm

**Fornitura:** vasca con piletta da 3½", sifone e tappo a cestello InFino



**Accessori idonei:**



Scarico InFino a saltarello integrato con comando PushControl di serie



**BLANCO CLARON 400-IF/A**

Raggio interno/esterno 10 mm

1515642

1.219,00

Sopratop bordo 1 mm e filotop

Dimensioni intaglio per incasso sopratop: 440x490 mm - R 15  
Profondità vasca: 190 mm

**Fornitura:** vasca con piletta da 3½", sifone, tappo a cestello InFino e saltarello mod. 1

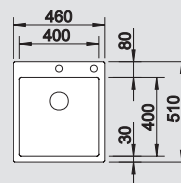

**BLANCO UNIT con BLANCO CLARON**

Miscelatore  
BLANCO LINEE-S



Cod. 1517593  
Euro 1.400,00

Raccolta differenziata  
BLANCO SOLON-IF



Cod. 1512471  
Euro 1.129,00

Dissipatore BLANCO  
FWD Max



Cod. 1526648  
Euro 1.248,00

**NUOVO**







**Accessori opzionali**

BLANCO  
PushControl

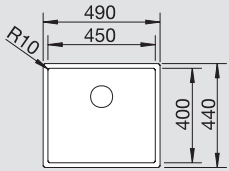

Cod. 1233696  
Euro 85,00

1

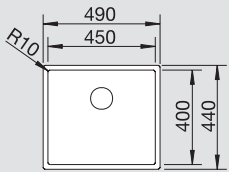
BLANCO CLARON 450 Acciaio Inox 18/10	Incasso	Dettagli Colore / Finitura	Codice	Euro	60 cm base sottolavello							
 <p><b>Accessori idonei:</b></p> <table border="1"> <tr> <td>1</td><td>2</td><td>3</td><td>4</td><td>5</td><td>6</td><td>7</td> </tr> </table>  Scarico InFino manuale integrato di serie	1	2	3	4	5	6	7	 <p>Sottotop</p>	<p><b>BLANCO CLARON 450-U</b></p> <p>Raggio interno 10 mm</p> <p>Dimensioni intaglio: 450x400 mm - R 10 Profondità vasca: 190 mm</p> <p><b>Fornitura:</b> vasca con piletta da 3½", sifone, tappo a cestello InFino e kit di montaggio</p>	1517215	987,00	
1	2	3	4	5	6	7						
 <p><b>Accessori idonei:</b></p> <table border="1"> <tr> <td>1</td><td>2</td><td>3</td><td>4</td><td>5</td><td>6</td><td>7</td> </tr> </table>  Scarico InFino manuale integrato di serie	1	2	3	4	5	6	7	 <p>Sopratop bordo 1 mm e filotop</p>	<p><b>BLANCO CLARON 450-IF</b></p> <p>Raggio interno/esterno 10 mm</p> <p>Dimensioni intaglio per incasso sopratop: 480x430 mm - R 15 Profondità vasca: 190 mm</p> <p><b>Fornitura:</b> vasca con piletta da 3½", sifone e tappo a cestello InFino</p>	1517214	1.173,00	
1	2	3	4	5	6	7						

Per il passaggio da scarico InFino manuale a scarico InFino a saltarello, è necessaria la sostituzione della piletta (v. pag. 265 - Cod. 1232459)

Per i modelli -IF è necessario prevedere uno scanso nello spessore del top per l'alloggiamento del troppopieno (v. pag. 260)

**Nota:** per i modelli con fascia miscelatore è possibile effettuare fori supplementari, previo Vs. disegno esecutivo e nostra approvazione, al costo di Euro 20,00 cad. netto

#### Accessori opzionali

**Vaschetta forata  
in acciaio inox 18/10**



Cod. 1219649  
Euro 448,00

2

**Tagliere in cristallo satinato  
bianco - per gocciolatoio**



Cod. 1225333  
Euro 459,00

3

**Gocciolatoio scorrevole  
in acciaio inox**

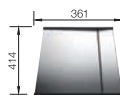

Cod. 1223067  
Euro 555,00

4

**Tagliere massello  
con maniglia inox**



Cod. 1223074  
Euro 647,00

5

**Barre in  
acciaio inox**



Cod. 1235906  
Euro 205,00

6

**Griglia pieghevole  
multifunzione**



Cod. 1238482  
Euro 181,00

7

**BLANCO CLARON 500**  
Acciaio Inox 18/10



**Accessori idonei:**



Scarico InFino manuale integrato di serie

**Incasso**

**Dettagli**  
Colore / Finitura

**Codice**

**Euro**



**BLANCO CLARON 500-U**

Raggio interno 10 mm

1517217

1.038,00

Dimensioni intaglio: 500x400 mm - R 10  
Profondità vasca: 190 mm

**Fornitura:** vasca con piletta da 3½", sifone, tappo a cestello InFino e kit di montaggio



**BLANCO CLARON 500-IF**

Raggio interno/esterno 10 mm

1517216

1.180,00

Dimensioni intaglio per incasso sopratop: 530x430 mm - R 15  
Profondità vasca: 190 mm

**Fornitura:** vasca con piletta da 3½", sifone e tappo a cestello InFino



**BLANCO CLARON 500-IF/A**

Raggio interno/esterno 10 mm

1515643

1.310,00

Dimensioni intaglio per incasso sopratop: 540x490 mm - R 15  
Profondità vasca: 190 mm

**Fornitura:** vasca con piletta da 3½", sifone, tappo a cestello InFino e saltarello mod. 1



**Accessori idonei:**



Scarico InFino a saltarello integrato con comando PushControl di serie

**60** cm base sottolavello

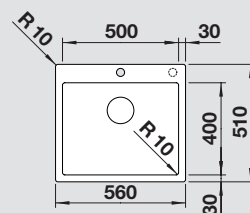
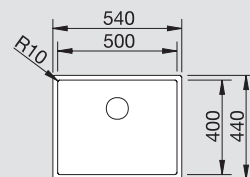
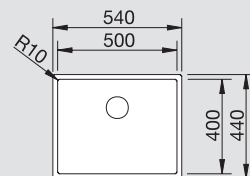

**BLANCO UNIT con BLANCO CLARON**

**Miscelatore**  
BLANCO LINEE-S



Cod. 1517593  
Euro 1.400,00

**Raccolta differenziata**  
BLANCO SOLON-IF



Cod. 1512471  
Euro 1.129,00

**Dissipatore** BLANCO  
FWD Max



Cod. 1526648  
Euro 1.248,00

**NUOVO**

**BLANCO**  
PushControl



Cod. 1233696  
Euro 85,00

1



**BLANCO CLARON 550**  
Acciaio Inox 18/10

**Incasso**

**Dettagli**  
Colore / Finitura

**Codice**

**Euro**

**75\*/80** cm base  
sottolavello



**BLANCO CLARON 550-U**

Raggio interno 10 mm

1517221

1.060,00

Dimensioni intaglio: 550x400 mm - R 10  
Profondità vasca: 190 mm

**Fornitura:** vasca con piletta da 3½", sifone, tappo a cestello InFino e kit di montaggio

**\*Adatto a basi sottolavello da 75 cm**

**Accessori idonei:**



Scarico InFino  
manuale integrato  
di serie

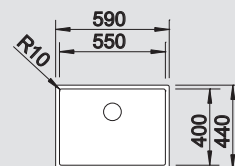

**BLANCO CLARON 550-IF**

Raggio interno/esterno 10 mm

1517220

1.214,00

Dimensioni intaglio per incasso sopratop: 580x430 mm - R 15  
Profondità vasca: 190 mm

**Fornitura:** vasca con piletta da 3½", sifone e tappo a cestello InFino

**Accessori idonei:**



Scarico InFino  
manuale integrato  
di serie

**80** cm base  
sottolavello

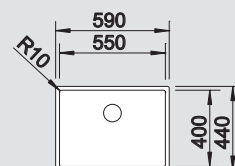

**BLANCO CLARON 550-IF/A**

Raggio interno/esterno 10 mm

1516797

1.327,00

Dimensioni intaglio per incasso sopratop: 590x490 mm - R 15  
Profondità vasca: 190 mm

**Fornitura:** vasca con piletta da 3½", sifone, tappo a cestello InFino e saltarello mod.

**Accessori idonei:**



Scarico InFino a saltarello  
integrato con comando  
PushControl di serie

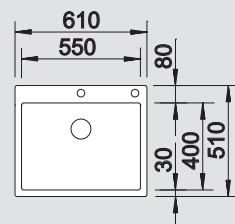

Per il passaggio da scarico InFino manuale a scarico InFino a saltarello, è necessaria la sostituzione della piletta (v. pag. 265 - Cod. 1232459)

Per i modelli -IF è necessario prevedere uno scanco nello spessore del top per l'alloggiamento del troppopieno (v. pag. 260)

**Nota:** per i modelli con fascia miscelatore è possibile effettuare fori supplementari, previo Vs. disegno esecutivo e nostra approvazione, al costo di Euro 20,00 cad. netto

**Accessori opzionali**

**Vaschetta forata**  
in acciaio inox 18/10



Cod. Euro 1219649 448,00

**Tagliere in cristallo satinato**  
bianco - per gocciolatoio



Cod. Euro 1225333 459,00

**Gocciolatoio scorrevole**  
in acciaio inox

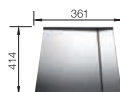

Cod. Euro 1223067 555,00

**Tagliere massello**  
con maniglia inox



Cod. Euro 1223074 647,00

**Barre in**  
acciaio inox



Cod. Euro 1235906 205,00

**Griglia pieghevole**  
multifunzione



Cod. Euro 1238482 181,00

**BLANCO CLARON 700**  
Acciaio Inox 18/10



**Accessori idonei:**



Scarico InFino manuale integrato di serie

**Incasso**

**Dettagli**  
Colore / Finitura

**Codice**

**Euro**



**BLANCO CLARON 700-U**

Raggio interno 10 mm

1517223

1.095,00

Dimensioni intaglio: 700x400 mm - R 10  
Profondità vasca: 190 mm

**Fornitura:** vasca con piletta da 3½", sifone, tappo a cestello InFino e kit di montaggio



**80** cm base  
sottolavello

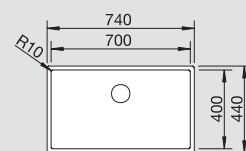

**Accessori idonei:**



Scarico InFino manuale integrato di serie



**BLANCO CLARON 700-IF**

Raggio interno/esterno 10 mm

1517222

1.253,00

Sopratop  
bordo 1 mm  
e filotop

Dimensioni intaglio per incasso sopratop: 730x430 mm - R 15  
Profondità vasca: 190 mm

**Fornitura:** vasca con piletta da 3½", sifone e tappo a cestello InFino

**80** cm base  
sottolavello

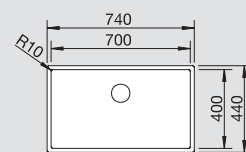

**Accessori idonei:**



Scarico InFino a saltarello integrato con comando PushControl di serie



**BLANCO CLARON 700-IF/A**

Raggio interno/esterno 10 mm

1515644

1.441,00

Sopratop  
bordo 1 mm  
e filotop

Dimensioni intaglio per incasso sopratop: 740x490 mm - R 15  
Profondità vasca: 190 mm

**Fornitura:** vasca con piletta da 3½", sifone, tappo a cestello InFino e saltarello mod.  1

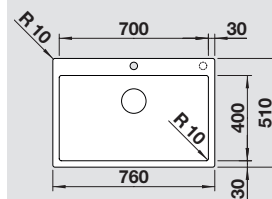

**BLANCO UNIT con BLANCO CLARON**

Miscelatore BLANCO LINEE-S in acciaio massiccio satinato opaco



Cod. 1517593  
Euro 1.400,00

Raccolta differenziata BLANCO SOLON-IF



Cod. 1512471  
Euro 1.129,00

Dissipatore BLANCO FWD Max



Cod. 1526648  
Euro 1.248,00

**NUOVO**

**Accessori opzionali**

BLANCO PushControl



Cod. 1233696  
Euro 85,00

1

**BLANCO CLARON 340/180**  
Acciaio Inox 18/10

**Incasso**

**Dettagli**  
Colore / Finitura

**Codice**

**Euro**

**75\*/80** cm base  
sottolavello



**BLANCO CLARON 340/180-U**

Raggio interno 10 mm

Vasca DX  
Vasca SX

1517227  
1517226

1.928,00  
1.928,00

Accessori idonei:



Scarico InFino  
manuale integrato  
di serie

Dimensioni intaglio: 545x400 mm - R 10  
Profondità vasche: 190/130 mm

Fornitura: vasche con piletta da 3½", sifone, tappo a cestello  
e kit di montaggio

**\*Adatto a basi sottolavello da 75 cm**

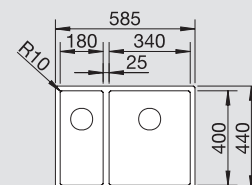

**BLANCO CLARON 340/180-IF**

Raggio interno/esterno 10 mm

Vasca DX  
Vasca SX

1517225  
1517224

2.280,00  
2.280,00

Accessori idonei:



Scarico InFino  
manuale integrato  
di serie

Dimensioni intaglio per incasso sopra-top: 575x430 mm - R 15  
Profondità vasche: 190/130 mm

Fornitura: vasche con piletta da 3½", sifone e tappo a cestello

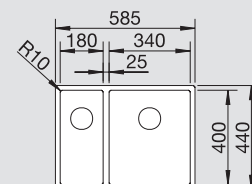

**BLANCO CLARON 340/180-IF/A**

Raggio interno/esterno 10 mm

Vasca DX  
Vasca SX

1514204

2.512,00

Accessori idonei:



Scarico InFino a saltarello  
integrato con comando  
PushControl di serie

Dimensioni intaglio per incasso sopra-top: 585x490 mm - R 15  
Profondità vasche: 190/130 mm

Fornitura: vasche con piletta da 3½", sifone, tappo a cestello e saltarello  
mod. 1 per la vasca principale

**Disponibile solo con vasca principale a destra**

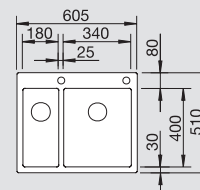

Per il passaggio da scarico InFino manuale a scarico InFino a saltarello, è necessaria la sostituzione della piletta (v. pag. 265 - Cod. 1232459)

Per i modelli -IF è necessario prevedere uno scanco nello spessore del top per l'alloggiamento del troppopieno (v. pag. 260)

Nota: per i modelli con fascia miscelatore è possibile effettuare fori supplementari, previo Vs. disegno esecutivo e nostra approvazione, al costo di Euro 20,00 cad. netto

**Accessori opzionali**

**Vaschetta forata**  
in acciaio inox 18/10



Cod. 1219649  
Euro 448,00

2

**Tagliere in cristallo satinato**  
bianco - per gocciolatoio



Cod. 1225333  
Euro 459,00

3

**Gocciolatoio scorrevole**  
in acciaio inox

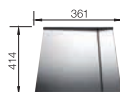

Cod. 1223067  
Euro 555,00

4

**Tagliere massello**  
con maniglia inox



Cod. 1223074  
Euro 647,00

5

**Barre in**  
acciaio inox



Cod. 1235906  
Euro 205,00

6

**Griglia pieghevole**  
multifunzione



Cod. 1238482  
Euro 181,00

7

**BLANCO CLARON 400/400**  
Acciaio Inox 18/10



**Accessori idonei:**



Scarico InFino  
manuale integrato  
di serie

**Incasso**

**Dettagli**  
Colore / Finitura

**Codice**

**Euro**



Sottotop

**BLANCO CLARON 400/400-U**

Raggio interno/esterno 10 mm

1517231

2.070,00

Dimensioni intaglio: 825x400 mm - R 10  
Profondità vasche: 190 mm

Fornitura: vasche con piletta da 3½", sifone e tappo a cestello InFino

**100** cm base  
sottolavello

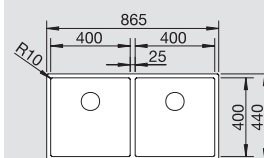

**Accessori idonei:**



Scarico InFino  
manuale integrato  
di serie



Sopratop  
bordo 1 mm  
e filotop

**BLANCO CLARON 400/400-IF**

Raggio interno/esterno 10 mm

1517230

2.421,00

Dimensioni intaglio per incasso sopratop: 855x430 mm - R 15  
Profondità vasche: 190 mm

Fornitura: vasche con piletta da 3½", sifone e tappo a cestello InFino

**90** cm base  
sottolavello

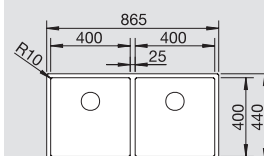

**Accessori idonei:**



Scarico InFino a saltarello  
integrato con comando  
PushControl di serie



Sopratop  
bordo 1 mm  
e filotop

**BLANCO CLARON 400/400-IF/A**

Raggio interno/esterno 10 mm

1514206

2.654,00

Dimensioni intaglio per incasso sopratop: 865x490 mm - R 15  
Profondità vasche: 190 mm

Fornitura: vasche con piletta da 3½", sifone, tappo a cestello InFino e saltarello mod.  1 per una vasca

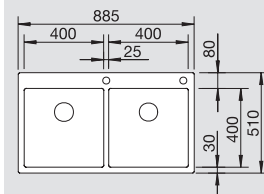

**BLANCO UNIT con BLANCO CLARON**

Miscelatore BLANCO LINEE-S  
in acciaio massiccio satinato opaco



Cod. 1517593  
Euro 1.400,00

Raccolta differenziata  
BLANCO SOLON-IF



Cod. 1512471  
Euro 1.129,00

Dissipatore BLANCO  
FWD Max



Cod. 1526648  
Euro 1.248,00

**NUOVO**

**Accessori opzionali**

BLANCO  
PushControl



Cod. 1233696  
Euro 85,00

1



**BLANCO CLARON 4 S-IF**  
Acciaio Inox 18/10

**Incasso**

**Dettagli**  
Colore / Finitura

**Codice**

**Euro**

**40** cm base  
sottolavello



Sopratop  
bordo 1 mm  
e filotop

Raggio interno/esterno 10 mm

Vasca DX  
Vasca SX

1513997 2.478,00  
1513998 2.478,00

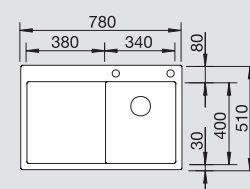

Spessore piano di lavoro: min. 30 mm

Accessori idonei:



Scarico InFinO a saltarello  
integrato con comando  
PushControl di serie

Dimensioni intaglio per incasso sopratop: 760x490 mm - R 15  
Profondità vasca: 190 mm - Gocciolatoio: 13-20 mm

Fornitura: vasca con piletta da 3/2", sifone, tappo a cestello InFinO  
e saltarello mod.  1

**BLANCO CLARON 5 S-IF**  
Acciaio Inox 18/10

**Incasso**

**Dettagli**  
Colore / Finitura

**Codice**

**Euro**

**60** cm base  
sottolavello



Sopratop  
bordo 1 mm  
e filotop

Raggio interno/esterno 10 mm

Vasca DX  
Vasca SX

1513999 2.512,00  
1514000 2.512,00

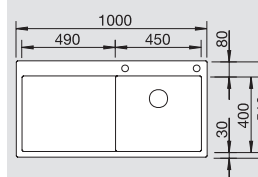

Spessore piano di lavoro: min. 30 mm

Accessori idonei:



Scarico InFinO a saltarello  
integrato con comando  
PushControl di serie

Dimensioni intaglio per incasso sopratop: 980x490 mm - R 15  
Profondità vasca: 190 mm - Gocciolatoio: 13-20 mm

Fornitura: vasca con piletta da 3/2", sifone, tappo a cestello InFinO  
e saltarello mod.  1

**BLANCO CLARON 6 S-IF**  
Acciaio Inox 18/10

**Incasso**

**Dettagli**  
Colore / Finitura

**Codice**

**Euro**

**60** cm base  
sottolavello



Sopratop  
bordo 1 mm  
e filotop

Raggio interno/esterno 10 mm

Vasca DX  
Vasca SX

1514001 3.233,00  
1514002 3.233,00

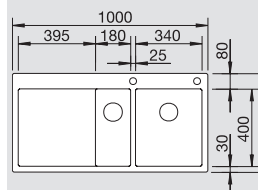

Spessore piano di lavoro: min. 30 mm

Accessori idonei:



Scarico InFinO a saltarello  
integrato con comando  
PushControl di serie

Dimensioni intaglio per incasso sopratop: 980x490 mm - R 15  
Profondità vasche: 190/130 mm - Gocciolatoio 13-20 mm

Fornitura: vasche con piletta da 3/2", sifone, tappo a cestello InFinO  
e saltarello mod.  1 per la vasca principale

Per il passaggio da scarico InFinO manuale a scarico InFinO a saltarello, è necessaria la sostituzione della piletta (v. pag. 265 - Cod. 1232459)

Per i modelli -IF è necessario prevedere uno scanco nello spessore del top per l'alloggiamento del troppopieno (v. pag. 260)

Nota: per i modelli con fascia miscelatore è possibile effettuare fori supplementari, previo Vs. disegno esecutivo e nostra approvazione, al costo di Euro 20,00 cad. netto

**Accessori opzionali**

**Vaschetta forata**  
in acciaio inox 18/10



Cod. 1219649  
Euro 448,00

2

**Tagliere in cristallo satinato**  
bianco - per gocciolatoio



Cod. 1225333  
Euro 459,00

3

**Gocciolatoio scorrevole**  
in acciaio inox

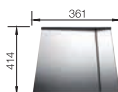

Cod. 1223067  
Euro 555,00

4

**Tagliere massello**  
con maniglia inox



Cod. 1223074  
Euro 647,00

5

**Barre in**  
acciaio inox



Cod. 1235906  
Euro 205,00

6

**Griglia pieghevole**  
multifunzione



Cod. 1238482  
Euro 181,00

7

# BLANCO ZEROX Dark Steel

L'innovazione in BLANCO è di casa.

VASCHE  
INOX



Lavello: BLANCO ZEROX 700-U Dark Steel

Miscelatore: BLANCO PANERA-S



La superficie vellutata al tatto rende questo materiale unico ed esclusivo: nessuno strato di rivestimento, né colorazione superficiale.



Per la realizzazione di BLANCO Dark Steel, non vengono utilizzati né colori, né pigmenti, né smalti o laccature: è materiale puro.



Perfettamente in linea con i trend attuali.



**BLANCO ZEROX Dark Steel: materiale innovativo** per le vasche a raggio 0 mm.

L'acciaio BLANCO Dark Steel è un materiale **esclusivo** dall'aspetto opaco, prodotto attraverso un **processo elettrochimico** totalmente informatizzato, dalla struttura e **finitura opaca**, è un materiale morbido al tatto, semplice da pulire (le impronte sono facilmente eliminabili), che non subisce alterazioni di colore nel tempo. Adatto al contatto coi cibi, BLANCO Dark Steel è **materiale puro**: una superficie unica, perfettamente in linea con i trend attuali, dal design sofisticato e con un look industriale, scuro e moderno.



VASCHE  
INOX

Puro stile ed eleganza per questo innovativo materiale, risultato dell'impegno che BLANCO mette sempre nella ricerca di soluzioni innovative e tecnologiche che non rinunciano all'estetica.

R<sup>est</sup> = 4  
R<sup>int</sup> = 0



Tipologia  
di incasso:



BLANCO ZEROX 500-U



BLANCO ZEROX 700-U



BLANCO ZEROX 500-IF



BLANCO ZEROX 700-IF

#### Eleganti vasche in acciaio inox nella splendida finitura Dark steel

- Puro, innovativo acciaio inox
- Look caldo e vellutato al tatto
- Due diverse dimensioni di vasche per installazione sottotop o con bordo -IF per installazione filotop/sopratop
- Semplicità di pulizia

Maggiori informazioni su [blanco.com/it](http://blanco.com/it)









# BLANCO ZEROX 500 Dark Steel

L'acciaio come non lo avete mai visto.

- Resistente, caldo e vellutato al tatto
- Nessuno strato di rivestimento, né colorazione superficiale
- Impronte eliminabili facilmente e ottima resistenza alle macchie
- Perfettamente in linea con i trend attuali
- Design sofisticato e look industriale
- Scuro e moderno, dallo stile minimalista

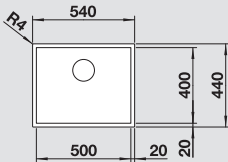
VASCHE  
INOX

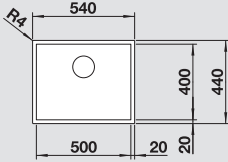
BLANCO ZEROX 500 Dark Steel	Incasso	Dettagli Colore / Finitura	Codice	Euro	60 cm base sottolavello
 <p>Scarico InFino® manuale integrato di serie</p>	 <p>Sottotop</p>	<p><b>BLANCO ZEROX 500-U</b></p> <p>Raggio interno 0 mm</p> <p>Raggio esterno: 4 mm</p> <p>Dimensioni intaglio: 500x400 mm Profondità vasca: 175 mm</p> <p><b>Fornitura:</b> vasca con piletta da 3½", sifone, tappo a cestello InFino®, kit di montaggio</p>	1526243	1.129,00	
 <p>Scarico InFino® manuale integrato di serie</p>	 <p>Sopratop bordo 1 mm e filotop</p>	<p><b>BLANCO ZEROX 500-IF</b></p> <p>Raggio interno 0 mm</p> <p>Raggio esterno: 4 mm</p> <p>Dimensioni intaglio: 530x430 mm Profondità vasca: 175 mm</p> <p><b>Fornitura:</b> vasca con piletta da 3½", sifone, tappo a cestello InFino®</p>	1526245	1.383,00	

Per installazione su top di altezza inferiore ai 30 mm e fino a 15 mm di spessore, usare set ganci cod. 1223742 (v. pag. 258)

## BLANCO UNIT con BLANCO ZEROX Dark Steel

## Accessori opzionali

Miscelatore  
BLANCO LINEE-S



Cod. 1517593  
Euro 1.400,00

Raccolta differenziata  
BLANCO FLEXON II 60/3 Low



Cod. 1526642  
Euro 239,00

Kit scarico singolo  
Total Black



Cod. 1239975  
Euro 171,00

Tagliere massello  
con maniglia inox



Cod. 1223074  
Euro 647,00

Barre in  
acciaio inox



Cod. 1235906  
Euro 205,00

Vaschetta forata  
in acciaio inox 18/10



Cod. 1219649  
Euro 448,00





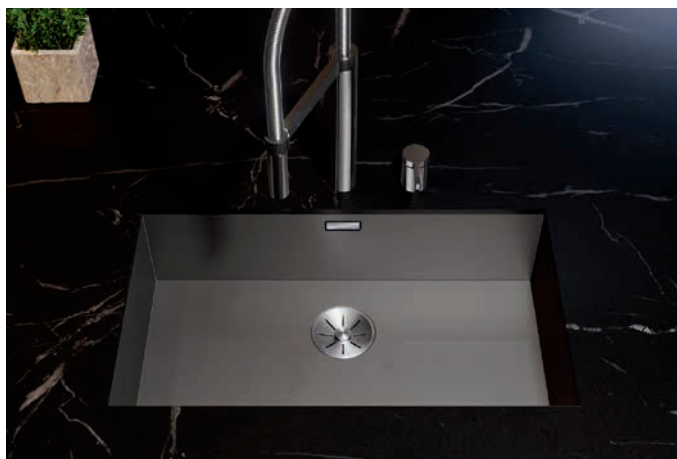

# BLANCO ZEROX 700 Dark Steel

L'acciaio come non lo avete mai visto.

- Resistente, caldo e vellutato al tatto
- Nessuno strato di rivestimento, né colorazione superficiale
- Impronte eliminabili facilmente e ottima resistenza alle macchie
- Perfettamente in linea con i trend attuali
- Design sofisticato e look industriale
- Scuro e moderno, dallo stile minimalista

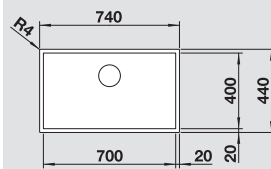

BLANCO ZEROX 700-U Dark Steel	Incasso	Dettagli Colore / Finitura	Codice	Euro	80 cm base sottolavello
 <p>Scarico InFino® manuale integrato di serie</p>	 <p>Sottotop</p>	<p><b>BLANCO ZEROX 700-U</b></p> <p>Raggio interno 0 mm</p> <p>Raggio esterno: 4 mm</p> <p>Dimensioni intaglio: 700x400 mm Profondità vasca: 185 mm</p> <p><b>Fornitura:</b> vasca con pileta da 3½", sifone, tappo a cestello InFino®, kit di montaggio</p>	1526244	1.253,00	
 <p>Scarico InFino® manuale integrato di serie</p>	 <p>Sopratop bordo 1 mm e filotop</p>	<p><b>BLANCO ZEROX 700-IF</b></p> <p>Raggio interno 0 mm</p> <p>Raggio esterno: 4 mm</p> <p>Dimensioni intaglio: 730x430 mm Profondità vasca: 185 mm</p> <p><b>Fornitura:</b> vasca con pileta da 3½", sifone, tappo a cestello InFino®</p>	1526246	1.503,00	

VASCHE  
INOX

Per installazione su top di altezza inferiore ai 30 mm e fino a 15 mm di spessore, usare set ganci cod. 1223742 (v. pag. 258)

BLANCO UNIT con BLANCO ZEROX Dark Steel		Accessori opzionali			
<p>Miscelatore BLANCO LINEE-S</p>  <p>Cod. 1517593 Euro 1.400,00</p>	<p>Raccolta differenziata BLANCO FLEXON II 60/4 Low</p>  <p><b>NUOVO</b></p> <p>Cod. 1526644 Euro 284,00</p>	<p>Kit scarico singolo Total Black</p>  <p><b>NUOVO</b></p> <p>Cod. 1239975 Euro 171,00</p>	<p>Gocciolatoio scorrevole in acciaio inox</p>  <p>Cod. 1223067 Euro 555,00</p>	<p>Barre in acciaio inox</p>  <p>Cod. 1235906 Euro 205,00</p>	<p>Cestello in acciaio inox multifunzione</p>  <p>Cod. 1223297 Euro 215,00</p>

# BLANCO ZEROX -U, -IF, -IF/A

Design a raggio 0 mm

VASCHE  
INOX



Vasca: **BLANCO ZEROX 700-IF/A**

Miscelatore: **BLANCO CULINA-S**



BLANCO ZEROX 400-U / -IF



BLANCO ZEROX 450-U



BLANCO ZEROX 500-U / -IF



BLANCO ZEROX 550-U / -IF  
BLANCO ZEROX 550-IF/A



BLANCO ZEROX 700-U / -IF  
BLANCO ZEROX 700-IF/A



BLANCO ZEROX 550-IF/A



BLANCO ZEROX 700-IF/A



La serie di vasche e lavelli **BLANCO ZEROX** (con fascia miscelatore) offre la massima versatilità, essendo incassabile sia sopratop, sia filotop. Sono tutti caratterizzati dal raggio interno da 0 mm e dal disegno a diamante sul fondo vasca, che li rendono eleganti e preziosi. Saldati e rifiniti a mano, con uno spessore di 1 mm, i modelli **BLANCO ZEROX** rappresentano il massimo per design e solidità.



Disponibile in Dark Steel,  
v. pagg. 56-59



Disponibile in Durinox,  
v. pagg. 76-79



Gli accessori dopzionali di alta qualità rendono questa famiglia di vasche ancorapiù funzionale.



BLANCO ZEROX 340/180-U / -IF  
BLANCO ZEROX 340/180-IF/A



BLANCO ZEROX 400/400-U



BLANCO ZEROX 340/180-IF/A

**BLANCO ZEROX 400**  
Acciaio Inox 18/10



Accessori idonei:



Scarico InFino  
manuale integrato  
di serie

Incasso	Dettagli Colore / Finitura	Codice	Euro
---------	-------------------------------	--------	------



**BLANCO ZEROX 400-U**

Raggio interno 0 mm

1517241 697,00

Dimensioni intaglio: 400x400 mm  
Profondità vasca: 175 mm

**Fornitura:** vasca con piletta da 3/2", sifone, tappo a cestello InFino e kit di montaggio

**60** cm base  
sottolavello

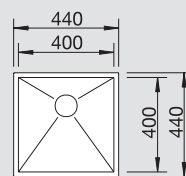

Accessori idonei:



Scarico InFino®  
manuale integrato  
di serie



**BLANCO ZEROX 400-IF**

Raggio interno 0 mm

R est. = 4 mm  
R est. = 10 mm

1517240 862,00  
1417240 862,00

Dimensioni intaglio per incasso sopratop: 430x430 mm  
Profondità vasca: 175 mm

**Fornitura:** vasca con piletta da 3/2", sifone e tappo a cestello InFino

**45** cm base  
sottolavello

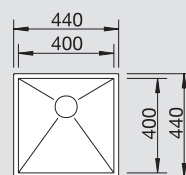

**BLANCO ZEROX 450**  
Acciaio Inox 18/10



Accessori idonei:



Scarico InFino®  
manuale integrato  
di serie

Incasso	Dettagli Colore / Finitura	Codice	Euro
---------	-------------------------------	--------	------



**BLANCO ZEROX 450-U**

Raggio interno 0 mm

1517243 726,00

Dimensioni intaglio: 450x400 mm  
Profondità vasca: 175 mm

**Fornitura:** vasca con piletta da 3/2", sifone, tappo a cestello InFino® e kit di montaggio

**60** cm base  
sottolavello

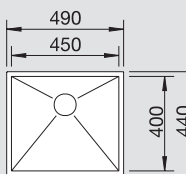

**BLANCO UNIT con BLANCO ZEROX**

Miscelatore BLANCO LINEE-S  
in acciaio massiccio satinato opaco



Cod. 1517593  
Euro 1.400,00

Raccolta differenziata  
BLANCO SELECT II 60/2 Orga



Cod. 1526208  
Euro 686,00

Dissipatore BLANCO  
FWD Max



Cod. 1526648  
Euro 1.248,00

**Accessori opzionali**

BLANCO  
PushControl



Cod. 1233696  
Euro 85,00

1



**BLANCO ZEROX 500**  
Acciaio Inox 18/10

**Incasso**

**Dettagli**  
Colore / Finitura

**Codice**

**Euro**



**60**

cm base  
sottolavello



Sottotop

**BLANCO ZEROX 500-U**

Raggio interno 0 mm

1517245

760,00

Dimensioni intaglio: 500x400 mm  
Profondità vasca: 175 mm

**Fornitura:** vasca con piletta da 3½", sifone, tappo a cestello InFino e kit di montaggio

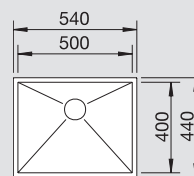

**Accessori idonei:**



Scarico InFino  
manuale integrato  
di serie



Sopratop  
bordo 1 mm  
e filotop

**BLANCO ZEROX 500-IF**

Raggio interno 0 mm

R est. = 4 mm

1517244

924,00

R est. = 10 mm

1417244

924,00

Dimensioni intaglio per incasso sopratop: 530x430 mm  
Profondità vasca: 175 mm

**Fornitura:** vasca con piletta da 3½", sifone e tappo a cestello InFino

**60**

cm base  
sottolavello

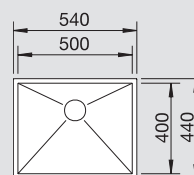

**Accessori idonei:**



Scarico InFino  
manuale integrato  
di serie

VASCHE  
INOX

Per il passaggio da scarico InFino manuale a scarico InFino a saltarello, è necessaria la sostituzione della piletta (v. pag. 265 - Cod. 1232459)

Per i modelli -IF è necessario prevedere uno scanso nello spessore del top per l'alloggiamento del troppopieno (v. pag. 260)

**Nota:** per i modelli con fascia miscelatore è possibile effettuare fori supplementari, previo Vs. disegno esecutivo e nostra approvazione, al costo di Euro 20,00 cad. netto

**Accessori opzionali**

**Vaschetta forata  
in acciaio inox 18/10**



Cod. 1219649  
Euro 448,00

2

**Tagliere in cristallo satinato  
bianco - per gocciolatoio**



Cod. 1225333  
Euro 459,00

3

**Gocciolatoio scorrevole  
in acciaio inox**

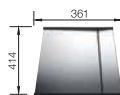

Cod. 1223067  
Euro 555,00

4

**Tagliere massello  
con maniglia inox**



Cod. 1223074  
Euro 647,00

5

**Barre in  
acciaio inox**



Cod. 1235906  
Euro 205,00

6

**Griglia pieghevole  
multifunzione**



Cod. 1238482  
Euro 181,00

7

**BLANCO ZEROX 550**  
Acciaio Inox 18/10



**Accessori idonei:**



Scarico InFino manuale integrato di serie

**Incasso**

**Dettagli**  
Colore / Finitura

**Codice**

**Euro**

**75\*/80** cm base sottolavello



**BLANCO ZEROX 550-U**

Raggio interno 0 mm

1517247 789,00

Dimensioni intaglio: 550x400 mm  
Profondità vasca: 175 mm

**Fornitura:** vasca con piletta da 3½", sifone, tappo a cestello InFino e kit di montaggio

**\*Adatto a basi sottolavello da 75 cm**

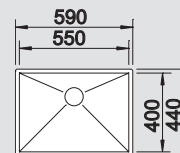

**80** cm base sottolavello

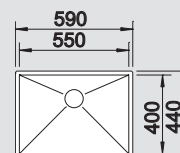

**Accessori idonei:**



Scarico InFino manuale integrato di serie



**BLANCO ZEROX 550-IF**

Raggio interno 0 mm

Sopratop bordo 1 mm e filotop

R est. = 4 mm  
R est. = 10 mm

1517246 965,00  
1417246 965,00

Dimensioni intaglio per incasso sopratop: 580x430 mm  
Profondità vasca: 175 mm

**Fornitura:** vasca con piletta da 3½", sifone e tappo a cestello InFino

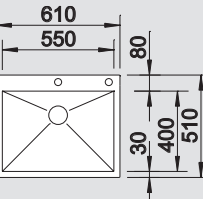

**Accessori idonei:**



Scarico InFino a saltarello integrato con comando PushControl di serie



**BLANCO ZEROX 550-IF/A**

Raggio interno 0 mm

Sopratop bordo 1 mm e filotop

R est. = 4 mm  
R est. = 10 mm

1516794 970,00  
1416794 970,00

Dimensioni intaglio per incasso sopratop: 590x490 mm - R 15  
Profondità vasca: 175 mm

**Fornitura:** vasca con piletta da 3½", sifone, tappo a cestello InFino e saltarello mod. 1

**BLANCO UNIT con BLANCO ZEROX**

Miscelatore BLANCO LINEE-S in acciaio massiccio satinato opaco



Cod. 1517593  
Euro 1.400,00

Raccolta differenziata BLANCO SELECT II 60/2 Orga



Cod. 1526208  
Euro 686,00

Dissipatore BLANCO FWD Max



Cod. 1526648  
Euro 1.248,00











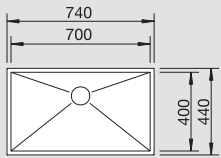

**Accessori opzionali**

BLANCO PushControl

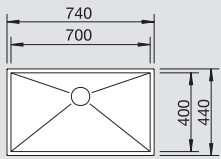

Cod. 1233696  
Euro 85,00

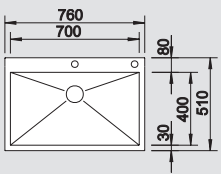
1

BLANCO ZEROX 700 Acciaio Inox 18/10	Incasso	Dettagli Colore / Finitura	Codice	Euro	 <b>80</b> cm base sottolavello
	 Sottotop	<b>BLANCO ZEROX 700-U</b> Raggio interno 0 mm	1517249	833,00	
<b>Accessori idonei:</b> 1 2 3 4 5 6 7		Dimensioni intaglio: 700x400 mm Profondità vasca: 185 mm			
 Scarico InFino manuale integrato di serie		<b>Fornitura:</b> vasca con piletta da 3½", sifone, tappo a cestello InFino e kit di montaggio			
	 Sopratop bordo 1 mm e filotop	<b>BLANCO ZEROX 700-IF</b> Raggio interno 0 mm	1517248	987,00	
<b>Accessori idonei:</b> 1 2 3 4 5 6 7		R est. = 4 mm R est. = 10 mm	1417248	987,00	
 Scarico InFino manuale integrato di serie		Dimensioni intaglio per incasso sopratop: 730x430 mm Profondità vasca: 185 mm			
		<b>Fornitura:</b> vasca con piletta da 3½", sifone e tappo a cestello InFino			
	 Sopratop bordo 1 mm e filotop	<b>BLANCO ZEROX 700-IF/A</b> Raggio interno 0 mm	1515641	1.009,00	
<b>Accessori idonei:</b> 2 3 4 5 6 7		R est. = 4 mm R est. = 10 mm	1415641	1.009,00	
 Scarico InFino a saltarello integrato con comando PushControl di serie		Dimensioni intaglio per incasso sopratop: 740x490 mm - R 15 Profondità vasca: 185 mm			
		<b>Fornitura:</b> vasca con piletta da 3½", sifone, tappo a cestello InFino e saltarello mod. <input type="text" value="1"/>			

Per il passaggio da scarico InFino manuale a scarico InFino a saltarello, è necessaria la sostituzione della piletta (v. pag. 265 - Cod. 1232459)

Per i modelli -IF è necessario prevedere uno scanco nello spessore del top per l'alloggiamento del troppopieno (v. pag. 260)

**Nota:** per i modelli con fascia miscelatore è possibile effettuare fori supplementari, previo Vs. disegno esecutivo e nostra approvazione, al costo di Euro 20,00 cad. netto

#### Accessori opzionali

**Vaschetta forata  
in acciaio inox 18/10**



Cod. 1219649  
Euro 448,00

**Tagliere in cristallo satinato  
bianco - per gocciolatoio**



Cod. 1225333  
Euro 459,00

**Gocciolatoio scorrevole  
in acciaio inox**

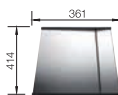

Cod. 1223067  
Euro 555,00

**Tagliere massello  
con maniglia inox**



Cod. 1223074  
Euro 647,00

**Barre in  
acciaio inox**



Cod. 1235906  
Euro 205,00

**Griglia pieghevole  
multifunzione**



Cod. 1238482  
Euro 181,00

**BLANCO ZEROX 340/180**  
Acciaio Inox 18/10



**Accessori idonei:**



Scarico InFino manuale integrato di serie

**Incasso**

**Dettagli**  
Colore / Finitura

**Codice**

**Euro**



Sottotop

**BLANCO ZEROX 340/180-U**

Raggio interno 0 mm

Vasca DX

1517255

1.458,00

Vasca SX

1517254

1.458,00

Dimensioni intaglio: 545x400 mm  
Profondità vasche: 175/130 mm

**Fornitura:** vasche con piletta da 3½", sifone, tappo a cestello InFino e kit di montaggio

**\*Adatto a basi sottolavello da 75 cm**

**75\*/80** cm base sottolavello

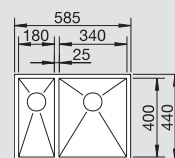

**60** cm base sottolavello



**Accessori idonei:**



Scarico InFino manuale integrato di serie



Sopratop  
bordo 1 mm  
e filotop

**BLANCO ZEROX 340/180-IF**

Raggio interno 0 mm

R est. = 4 mm - Vasca DX

1517253

1.759,00

R est. = 4 mm - Vasca SX

1517252

1.759,00

R est. = 10 mm - Vasca DX

1417253

1.759,00

R est. = 10 mm - Vasca SX

1417252

1.759,00

Dimensioni intaglio per incasso sopratop: 575x430 mm  
Profondità vasche: 175/130 mm

**Fornitura:** vasche con piletta da 3½", sifone e tappo a cestello InFino

**60** cm base sottolavello

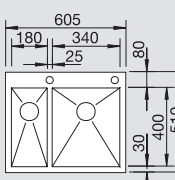

**Accessori idonei:**



Scarico InFino a saltarello integrato con comando PushControl di serie



Sopratop  
bordo 1 mm  
e filotop

**BLANCO ZEROX 340/180-IF/A**

Raggio interno 0 mm

R est. = 4 mm

1513701

1.798,00

R est. = 10 mm

1413701

1.798,00

Dimensioni intaglio per incasso sopratop: 585x490 mm - R 15  
Profondità vasche: 175/130 mm

**Fornitura:** vasche con piletta da 3½", sifone, tappo a cestello InFino e saltarello mod. 1 per vasca principale

Disponibile solo con vasca principale a destra

**Accessori opzionali**

**BLANCO**  
PushControl



Cod. 1233696  
Euro 85,00

**BLANCO UNIT con BLANCO ZEROX**

Miscelatore **BLANCO LINEE-S**  
in acciaio massiccio satinato opaco



Cod. 1517593  
Euro 1.400,00

Raccolta differenziata  
**BLANCO SELECT II 60/2 Orga**



Cod. 1526208  
Euro 686,00

**NUOVO**

Dissipatore **BLANCO FWD Max**



Cod. 1526648  
Euro 1.248,00

**NUOVO**



**BLANCO ZEROX 400/400**  
Acciaio Inox 18/10

**Incasso**

**Dettagli**  
Colore / Finitura

**Codice**

**Euro**

 **100** cm base  
sottolavello



**BLANCO ZEROX 400/400-U**

Raggio interno 0 mm

1517259

1.593,00

Dimensioni intaglio: 825x400 mm  
Profondità vasche: 175 mm

**Fornitura:** vasche con piletta da 3½", sifone, tappo a cestello InFino e kit di montaggio

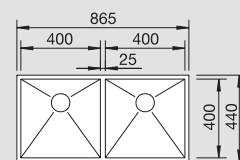

**Accessori idonei:**



Scarico InFino  
manuale integrato  
di serie



VASCHE  
INOX

Per il passaggio da scarico InFino manuale a scarico InFino a saltarello, è necessaria la sostituzione della piletta (v. pag. 265 - Cod. 1232459)

Per i modelli -IF è necessario prevedere uno scanco nello spessore del top per l'alloggiamento del troppopieno (v. pag. 260)

**Nota:** per i modelli con fascia miscelatore è possibile effettuare fori supplementari, previo Vs. disegno esecutivo e nostra approvazione, al costo di Euro 20,00 cad. netto

**Accessori opzionali**

**Vaschetta forata**  
in acciaio inox 18/10



Cod. Euro 1219649 448,00

2

**Tagliere in cristallo satinato**  
bianco - per gocciolatoio



Cod. Euro 1225333 459,00

3

**Gocciolatoio scorrevole**  
in acciaio inox

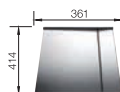

Cod. Euro 1223067 555,00

4

**Tagliere massello**  
con maniglia inox



Cod. Euro 1223074 647,00

5

**Barre in**  
acciaio inox



Cod. Euro 1235906 205,00

6

**Griglia pieghevole**  
multifunzione



Cod. Euro 1238482 181,00

7



# BLANCO DURINOX: L'ACCIAIO INOSSIDABILE NON È MAI STATO COSÌ RESISTENTE.

La resistenza e la durezza dell'acciaio Durinox incontra la perfezione delle vasche ZEROX e CLARON.

VASCHE  
INOX



Un'esclusiva superficie per le vasche, ottenuta da un nuovo processo di finitura.



L'elegante scarico InFino è integrato di serie nelle vasche in acciaio Durinox.



Una superficie unica, dal look morbido e vellutato.



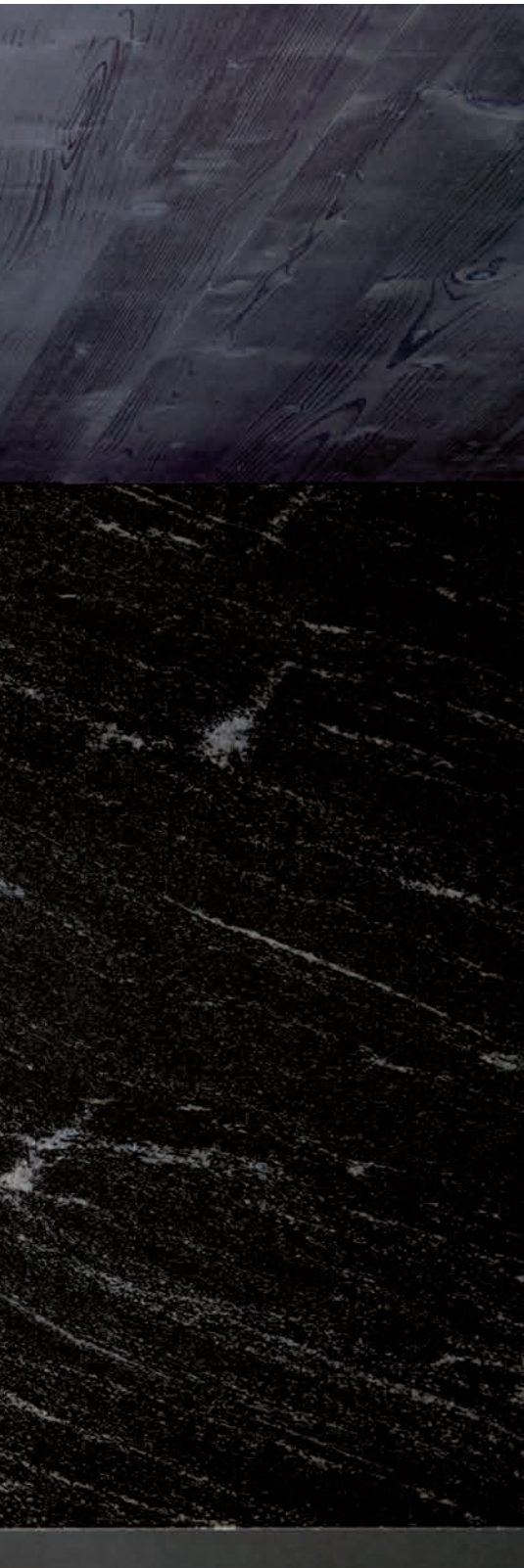

### Più resistente, più forte, più innovativo. Emozionante, non solo in superficie.

Anche quando siamo molto soddisfatti di ciò che abbiamo ottenuto, siamo sempre alla ricerca di qualcosa di nuovo e originale.

È per curiosità o più per ambizione? Questo è il modo in cui BLANCO SteelArt ha reinventato l'acciaio inossidabile: in un look brillante, un materiale due volte più duro e più resistente dell'acciaio inox tradizionale. Una novità rivoluzionaria che cambia tutto e stabilisce un nuovo riferimento internazionale.

Le superfici in acciaio inox Durinox ottengono queste speciali caratteristiche grazie ad un nuovo processo di finitura sviluppato dalla tecnologia aerospaziale e ora utilizzato da BLANCO.

Questo materiale è ottenuto grazie al bombardamento della superficie dell'acciaio con circa un miliardo di piccole sfere di acciaio, ad una velocità di quasi 300 km/h. Nascono così superfici di lavoro uniche che fissano nuovi standard non solo visivi ma anche tattili.

### Riconoscimenti ottenuti:



**GERMANY**  
SINCE 1925

Scopri di più:

[www.blanco.com/it](http://www.blanco.com/it)

- Superficie in acciaio inox estremamente resistente ai graffi (due volte più delle normali superfici in acciaio inox)
- Struttura omogenea della superficie
- Aspetto brillante e vellutato
- Incorpora tutte le caratteristiche positive dell'acciaio inox



# BLANCO CLARON -U, -IF, -IF/A DURINOX

Design e solidità ai massimi livelli

VASCHE  
INOX



Vasca: BLANCO CLARON 700-U

Miscelatore: BLANCOCULINA-S



BLANCO CLARON 340-U  
BLANCO CLARON 340-IF



BLANCO CLARON 400-U  
BLANCO CLARON 400-IF



BLANCO CLARON 500-U  
BLANCO CLARON 500-IF



BLANCO CLARON 700-U  
BLANCO CLARON 700-IF



BLANCO CLARON 400-IF/A



BLANCO CLARON 500-IF/A



BLANCO CLARON 700-IF/A



L'innovativo ed esclusivo acciaio inox Durinox continua il suo percorso verso il successo. Precedentemente disponibile solo per i piani di lavoro, BLANCO SteelArt ha adattato questo acciaio inox - due volte più resistente dell'acciaio inox standard - anche per le vasche singole.

BLANCO Durinox aggiunge eleganza ai modelli BLANCO CLARON. L'eccezionale omogeneità della sua superficie dal look vellutato, trasmette una sensazione di piacevole calore che, unita all'ampiezza delle vasche, crea un'unione perfetta tra design e praticità. Prodotte usando la moderna tecnologia della micropallinatura, le vasche in Durinox CLARON sono due volte più resistenti ai graffi.

La geometria perfettamente rettangolare delle vasche ne accresce la funzionalità e l'estetica. Eleganza ancora più perfetta, grazie al troppopieno rettangolare e al nuovo scarico InFino perfettamente integrato.



Tipologia  
di incasso:



Gli accessori opzionali, come le barre in acciaio inox, donano a BLANCO CLARON Durinox una funzionalità superiore, senza rinunciare all'estetica.



Tutte le vasche BLANCO CLARON Durinox con fascia miscelatore (-IF/A) includono il comando a saltarello PushControl di serie.

**BLANCO CLARON 340**  
Acciaio inox Durinox



**Accessori idonei:**



Scarico InFino  
manuale integrato  
di serie

**Incasso**

**Dettagli**  
Colore / Finitura

**Codice**

**Euro**

**45** cm base  
sottolavello



**BLANCO CLARON 340-U**

Raggio interno 10 mm

1523384

1.043,00

Dimensioni intaglio: 340x400 mm  
Profondità vasca: 190 mm

**Fornitura:** vasca con piletta da 3½", sifone, tappo a cestello InFino e kit di montaggio

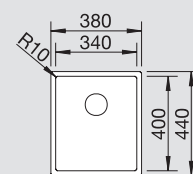

**Accessori idonei:**



Scarico InFino  
manuale integrato  
di serie



**BLANCO CLARON 340-IF**

Raggio interno/esterno 10 mm

1523388

1.248,00

Dimensioni intaglio per incasso sopratop: 370x430 mm  
Profondità vasca: 190 mm

**Fornitura:** vasca con piletta da 3½", sifone e tappo a cestello InFino



**45** cm base  
sottolavello

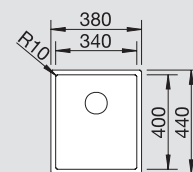

## BLANCO PushControl

Comando saltarello a pressione,  
incluso in fornitura

- Design ultra piatto: solo 3 mm
- Controllo aperto/chiuso dello scarico facile, preciso e affidabile
- Elegante e di alta qualità, valorizza qualsiasi cucina aggiungendo un tocco prezioso e funzionale.

### BLANCO UNIT con BLANCO CLARON Durinox

Miscelatore BLANCO PANERA-S  
in acciaio massiccio spazzolato



Cod. 1521547  
Euro 1.832,00

Raccolta differenziata  
BLANCO FLEXON II 60/3



Cod. 1521472  
Euro 312,00

Dissipatore BLANCO  
FWD Medium



Cod. 1526647  
Euro 965,00

**NUOVO**











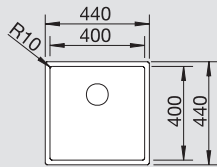

### Accessori opzionali

**BLANCO**  
PushControl

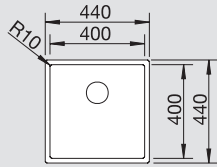

Cod. 1233696  
Euro 88,00

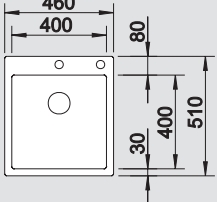
1

BLANCO CLARON 400 Acciaio inox Durinox	Incasso	Dettagli Colore / Finitura	Codice	Euro	60 cm base sottolavello
	 Sottotop	<b>BLANCO CLARON 400-U</b> Raggio interno 10 mm  Dimensioni intaglio: 400x400 mm Profondità vasca: 190 mm	1523385	1.106,00	
<b>Accessori idonei:</b> 1 2 3 4 5 6 7		<b>Fornitura:</b> vasca con piletta da 3½", sifone, tappo a cestello InFino e kit di montaggio			
 Scarico InFino manuale integrato di serie					
	 Sopratop bordo 1 mm e filotop	<b>BLANCO CLARON 400-IF</b> Raggio interno/esterno 10 mm  Dimensioni intaglio per incasso sopratop: 400x400 mm - R 15 Profondità vasca: 190 mm	1523389	1.310,00	
<b>Accessori idonei:</b> 1 2 3 4 5 6 7		<b>Fornitura:</b> vasca con piletta da 3½", sifone e tappo a cestello InFino			
 Scarico InFino manuale integrato di serie					
	 Sopratop bordo 1 mm e filotop	<b>BLANCO CLARON 400-IF/A</b> Raggio interno/esterno 10 mm  Dimensioni intaglio per incasso sopratop: 440x490 mm - R 15 Profondità vasca: 190 mm	1523392	1.407,00	
<b>Accessori idonei:</b> 2 3 4 5 6 7		<b>Fornitura:</b> vasca con piletta da 3½", sifone, tappo a cestello InFino e saltarello mod. 1			
 Scarico InFino a saltarello integrato con comando PushControl di serie					

Per il passaggio da scarico InFino manuale a scarico InFino a saltarello, è necessaria la sostituzione della piletta (v. pag. 265 - Cod. 1232459)

Per i modelli -IF è necessario prevedere uno scanco nello spessore del top per l'alloggiamento del troppopieno (v. pag. 260)

**Nota:** per i modelli con fascia miscelatore è possibile effettuare fori supplementari, previo Vs. disegno esecutivo e nostra approvazione, al costo di Euro 20,00 cad. netto

#### Accessori opzionali

**Vaschetta forata in acciaio inox 18/10**



Cod. 1219649  
Euro 448,00

2

**Tagliere in cristallo satinato bianco - per gocciolatoio**



Cod. 1225333  
Euro 459,00

3

**Gocciolatoio scorrevole in acciaio inox**

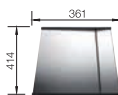

Cod. 1223067  
Euro 555,00

4

**Tagliere massello con maniglia inox**



Cod. 1223074  
Euro 647,00

5

**Barre in acciaio inox**



Cod. 1235906  
Euro 205,00

6

**Griglia pieghevole multifunzione**



Cod. 1238482  
Euro 181,00

7

**BLANCO CLARON 500**  
Acciaio inox Durinox



**Accessori idonei:**



Scarico InFino manuale integrato di serie

**Incasso**

**Dettagli**  
Colore / Finitura

**Codice**

**Euro**

**60** cm base sottolavello



**BLANCO CLARON 500-U**

Raggio interno 10 mm

1523386

1.191,00

Dimensioni intaglio: 500x400 mm - R 10  
Profondità vasca: 190 mm

**Fornitura:** vasca con piletta da 3½", sifone, tappo a cestello InFino e kit di montaggio

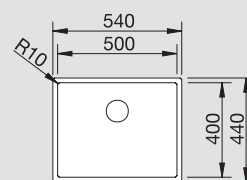

**Accessori idonei:**



Scarico InFino manuale integrato di serie



**BLANCO CLARON 500-IF**

Raggio interno/esterno 10 mm

1523390

1.366,00

Sopratop bordo 1 mm e filotop

Dimensioni intaglio per incasso sopratop: 530x430 mm - R 15  
Profondità vasca: 190 mm

**Fornitura:** vasca con piletta da 3½", sifone e tappo a cestello InFino

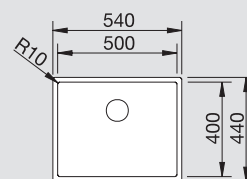

**Accessori idonei:**



Scarico InFino a saltarello integrato con comando PushControl di serie



**BLANCO CLARON 500-IF/A**

Raggio interno/esterno 10 mm

1523393

1.503,00

Sopratop bordo 1 mm e filotop

Dimensioni intaglio per incasso sopratop: 540x490 mm - R 15  
Profondità vasca: 190 mm

**Fornitura:** vasca con piletta da 3½", sifone, tappo a cestello InFino e saltarello mod.  1

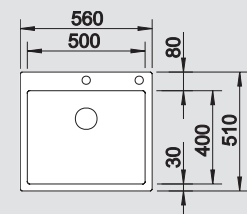

**BLANCO UNIT con BLANCO CLARON**

Miscelatore **BLANCO PANERA-S** in acciaio massiccio spazzolato



Cod. 1521547  
Euro 1.832,00

Raccolta differenziata **BLANCO FLEXON II 60/3**



Cod. 1521472  
Euro 312,00

Dissipatore **BLANCO FWD Medium**



Cod. 1526647  
Euro 965,00

**NUOVO**

**Accessori opzionali**

**BLANCO PushControl**



Cod. 1233696  
Euro 88,00

1



**BLANCO CLARON 700**  
Acciaio inox Durinox

**Incasso**

**Dettagli**  
Colore / Finitura

**Codice**

**Euro**



**80**

cm base  
sottolavello



**BLANCO CLARON 700-U**

Raggio interno 10 mm

1523387

1.259,00

Dimensioni intaglio: 700x400 mm - R 10  
Profondità vasca: 190 mm

**Fornitura:** vasca con piletta da 3½", sifone e tappo a cestello InFino

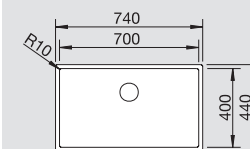

**Accessori idonei:**



Scarico InFino  
manuale integrato  
di serie



**BLANCO CLARON 700-IF**

Raggio interno/esterno 10 mm

1523391

1.441,00

Dimensioni intaglio per incasso sopra-top: 730x430 mm - R 15  
Profondità vasca: 190 mm

**Fornitura:** vasca con piletta da 3½", sifone e tappo a cestello InFino

**80**

cm base  
sottolavello

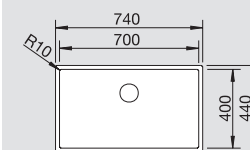

**Accessori idonei:**



Scarico InFino  
manuale integrato  
di serie



**BLANCO CLARON 700-IF/A**

Raggio interno/esterno 10 mm

1523394

1.656,00

Dimensioni intaglio per incasso sopra-top: 740x490 mm - R 15  
Profondità vasca: 190 mm

**Fornitura:** vasca con piletta da 3½", sifone, tappo a cestello InFino e saltarello mod.  1

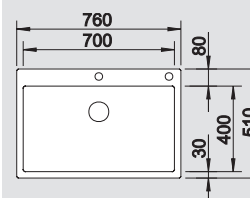

**Accessori idonei:**



Scarico InFino a saltarello  
integrato con comando  
PushControl di serie

Per il passaggio da scarico InFino manuale a scarico InFino a saltarello, è necessaria la sostituzione della piletta (v. pag. 265 - Cod. 1232459)

Per i modelli -IF è necessario prevedere uno scanco nello spessore del top per l'alloggiamento del troppopieno (v. pag. 260)

**Nota:** per i modelli con fascia miscelatore è possibile effettuare fori supplementari, previo Vs. disegno esecutivo e nostra approvazione, al costo di Euro 20,00 cad. netto

**Accessori opzionali**

**Vaschetta forata**  
in acciaio inox 18/10



Cod. 1219649  
Euro 448,00

2

**Tagliere in cristallo satinato**  
bianco - per gocciolatoio



Cod. 1225333  
Euro 459,00

3

**Gocciolatoio scorrevole**  
in acciaio inox

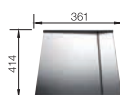

Cod. 1223067  
Euro 555,00

4

**Tagliere massello**  
con maniglia inox



Cod. 1223074  
Euro 647,00

5

**Barre in**  
acciaio inox



Cod. 1235906  
Euro 205,00

6

**Griglia pieghevole**  
multifunzione



Cod. 1238482  
Euro 181,00

7

# BLANCO ZEROX -U, -IF, -IF/A DURINOX

Carattere e personalità senza compromessi



L'innovativo ed esclusivo acciaio inox Durinox continua il suo percorso verso il successo. Precedentemente disponibile solo per i piani di lavoro, BLANCO SteelArt ha adattato questo acciaio inox- due volte più resistente dell'acciaio inox standard - **anche per le vasche singole.**

**BLANCO Durinox aggiunge eleganza ai modelli BLANCO ZEROX.** L'eccezionale omogeneità della sua superficie dal look vellutato, trasmette una sensazione di piacevole ore che, unita all'ampiezza delle vasche, crea un'unione perfetta tra design e praticità. Prodotte usando la moderna tecnologia della micropallinatura, **le vasche in Durinox ZEROX sono due volte più resistenti ai graffi.** La geometria perfettamente rettangolare delle vasche ne accresce la funzionalità e l'estetica. Eleganza ancora più perfetta, grazie al troppopieno rettangolare e al **nuovo scarico InFino perfettamente integrato.**



Il design a raggio 0 delle vasche BLANCO ZEROX è ulteriormente impreziosito da questo unico e innovativo materiale.

Tipologia  
di incasso:



**BLANCO ZEROX 400**  
Acciaio inox Durinox

**Incasso**

**Dettagli**  
Colore / Finitura

**Codice**

**Euro**

**60** cm base  
sottolavello



Sottotop

**BLANCO ZEROX 400-U**

Raggio interno 0 mm

1521558

799,00

Dimensioni intaglio: 400x400 mm  
Profondità vasca: 175 mm

**Fornitura:** vasca con pileta da 3½", sifone, tappo a cestello InFino e kit di montaggio

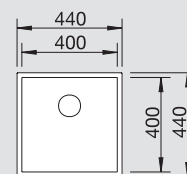

**Accessori idonei:**



Scarico InFino manuale integrato di serie



**45** cm base  
sottolavello



Sopratop  
bordo 1 mm  
e filotop

**BLANCO ZEROX 400-IF**

Raggio interno 0 mm

R. est. = 4 mm

1523097

992,00

Dimensioni intaglio per incasso sopratop: 430x430 mm  
Profondità vasca: 175 mm

**Fornitura:** vasca con pileta da 3½", sifone e tappo a cestello InFino

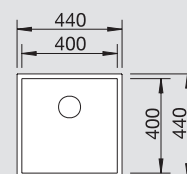

**Accessori idonei:**



Scarico InFino manuale integrato di serie



Sopratop  
bordo 1 mm  
e filotop

**BLANCO ZEROX 400-IF/A**

Raggio interno 0 mm

R est. = 4 mm

1523100

1.009,00

Dimensioni intaglio per incasso sopratop: 440x490 mm - R 15  
Profondità vasca: 175 mm

**Fornitura:** vasca con pileta da 3½", sifone, tappo a cestello InFino e saltarello mod. 1

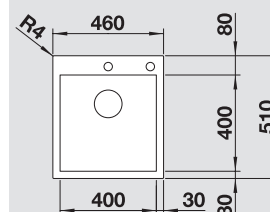

**Accessori idonei:**



Scarico InFino a saltarello integrato con comando PushControl di serie

Per il passaggio da scarico InFino manuale a scarico InFino a saltarello, è necessaria la sostituzione della pileta (v. pag. 260)

Per i modelli -IF è necessario prevedere uno scanco nello spessore del top per l'alloggiamento del troppopieno (v. pag. 260)

**Nota:** per i modelli con fascia miscelatore è possibile effettuare fori supplementari, previo Vs. disegno esecutivo e nostra approvazione, al costo di Euro 20,00 cad. netto

**Accessori opzionali**

**Vaschetta forata in acciaio inox 18/10**



Cod. 1219649  
Euro 448,00

2

**Tagliere in cristallo satinato bianco - per gocciolatoio**



Cod. 1225333  
Euro 459,00

3

**Gocciolatoio scorrevole in acciaio inox**

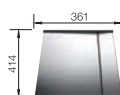

Cod. 1223067  
Euro 555,00

4

**Tagliere massello con maniglia inox**



Cod. 1223074  
Euro 647,00

5

**Barre in acciaio inox**



Cod. 1235906  
Euro 205,00

6

**Griglia pieghevole multifunzione**



Cod. 1238482  
Euro 181,00

7

**BLANCO ZEROX 500**  
Acciaio inox Durinox



**Accessori idonei:**



Scarico InFino manuale integrato di serie

**Incasso**

**Dettagli**  
Colore / Finitura

**Codice**

**Euro**



**60** cm base sottolavello



**BLANCO ZEROX 500-U**

Raggio interno 0 mm

1521559

873,00

Sottotop

Dimensioni intaglio: 500x400 mm  
Profondità vasca: 175 mm

**Fornitura:** vasca con pileta da 3½", sifone, tappo a cestello InFino e kit di montaggio

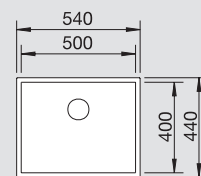

**60** cm base sottolavello



**Accessori idonei:**



Scarico InFino manuale integrato di serie



**BLANCO ZEROX 500-IF**

Raggio interno 0 mm

1523098

1.066,00

Sopratop bordo 1 mm e filotop

Dimensioni intaglio per incasso sopratop: 530x430 mm  
Profondità vasca: 175 mm

**Fornitura:** vasca con pileta da 3½", sifone e tappo a cestello InFino

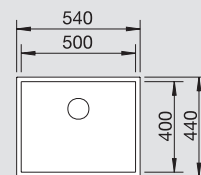

**Accessori idonei:**



Scarico InFino a saltarello integrato con comando PushControl di serie



**BLANCO ZEROX 500-IF/A**

Raggio interno 0 mm

1523101

1.0863,00

Sopratop bordo 1 mm e filotop

Dimensioni intaglio per incasso sopratop: 540x490 mm - R 15  
Profondità vasca: 175 mm

**Fornitura:** vasca con pileta da 3½", sifone, tappo a cestello InFino e saltarello mod. 1

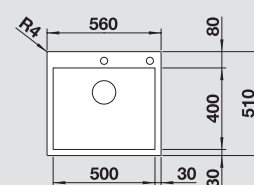

**BLANCO UNIT con BLANCO ZEROX Durinox**

Miscelatore BLANCO PANERA-S in acciaio massiccio spazzolato



Cod. 1521547  
Euro 1.832,00

Raccolta differenziata BLANCO FLEXON II 60/3



Cod. 1521472  
Euro 312,00

Dissipatore BLANCO FWD Medium



Cod. 1526647  
Euro 965,00

**NUOVO**

**Accessori opzionali**

BLANCO PushControl



Cod. 1233696  
Euro 85,00

1



**BLANCO ZEROX 700**  
Acciaio inox Durinox

**Incasso**

**Dettagli**  
Colore / Finitura

**Codice**

**Euro**



**80** cm base  
sottolavello



**BLANCO ZEROX 700-U**

Raggio interno 0 mm

1521560

965,00

Dimensioni intaglio: 700x400 mm  
Profondità vasca: 185 mm

**Fornitura:** vasca con piletta da 3½", sifone, tappo a cestello InFino e kit di montaggio

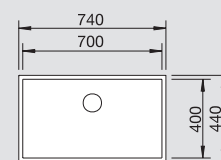

**Accessori idonei:**



Scarico InFino  
manuale integrato  
di serie

**80** cm base  
sottolavello



**BLANCO ZEROX 700-IF**

Raggio interno 0 mm

R est. = 4 mm

1523099

1.129,00

Dimensioni intaglio per incasso sopratop: 730x430 mm  
Profondità vasca: 185 mm

**Fornitura:** vasca con piletta da 3½", sifone e tappo a cestello InFino

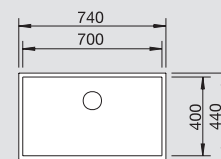

**Accessori idonei:**



Scarico InFino  
manuale integrato  
di serie



**BLANCO ZEROX 700-IF/A**

Raggio interno 0 mm

R est. = 4 mm

1523102

1.163,00

Dimensioni intaglio per incasso sopratop: 740x490 mm - R 15  
Profondità vasca: 185 mm

**Fornitura:** vasca con piletta da 3½", sifone, tappo a cestello InFino e saltarello mod.

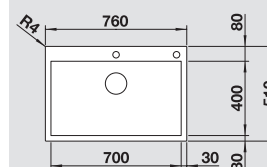

**Accessori idonei:**



Scarico InFino a saltarello  
integrato con comando  
PushControl di serie

Per il passaggio da scarico InFino manuale a scarico InFino a saltarello, è necessaria la sostituzione della piletta (v. pag. 265 - Cod. 1232459)

Per i modelli -IF è necessario prevedere uno scanco nello spessore del top per l'alloggiamento del troppopieno (v. pag. 260)

**Nota:** per i modelli con fascia miscelatore è possibile effettuare fori supplementari, previo Vs. disegno esecutivo e nostra approvazione, al costo di Euro 20,00 cad. netto

**Accessori opzionali**

**Vaschetta forata**  
in acciaio inox 18/10



Cod. 1219649  
Euro 448,00

**Tagliere in cristallo satinato**  
bianco - per gocciolatoio



Cod. 1225333  
Euro 459,00

**Gocciolatoio scorrevole**  
in acciaio inox

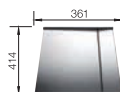

Cod. 1223067  
Euro 555,00

**Tagliere massello**  
con maniglia inox



Cod. 1223074  
Euro 647,00

**Barre in**  
acciaio inox



Cod. 1235906  
Euro 205,00

**Griglia pieghevole**  
multifunzione



Cod. 1238482  
Euro 181,00

# BLANCO ETAGON -U, -IF, -IF/A

Maggiore comfort grazie all'eccezionale funzionalità.

VASCHE  
INOX



## BLANCO ETAGON

-U e -IF

-U: Sottotop

-IF: Sopratop/Filotop



BLANCO ETAGON 500-U / -IF



BLANCO ETAGON 700-U / -IF

## BLANCO ETAGON

-IF/A

Sopratop/Filotop

con fascia miscelatore



BLANCO ETAGON 500-IF/A

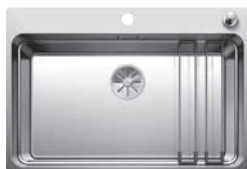

BLANCO ETAGON 700-IF/A



Le barre inox in dotazione ottimizzano e organizzano lo spazio all'interno della vasca.





**Puro ingegno: il lavello a livelli. 1 vasca, 2 barre, 3 livelli.**

BLANCO ETAGON è il lavello monovasca con un livello di funzionalità in più: il gradino integrato, unitamente alle guide ETAGON appositamente sviluppate, consente di lavorare sui tre livelli di questo lavello moderno e lineare. Collocate in posizione intermedia, le barre in acciaio inox possono sostenere padelle o vaschette, nelle quali possono ricadere le verdure affettate dal tagliere soprastante, mentre gli altri ingredienti restano a bagno nella vasca.



BLANCO ETAGON vanta funzionalità aumentata grazie all'ampia vasca e alle barre multifunzione (in dotazione) in acciaio inox.



Tipologia  
di incasso:



BLANCO ETAGON Silgranit,  
pag. 28-33



BLANCO ETAGON ceramica PuraPlus,  
pag. 110-111









# BLANCO ETAGON 500-U BLANCO ETAGON 500-IF BLANCO ETAGON 500-IF/A

Acciaio Inox 18/10

## Un lavello, tre livelli.

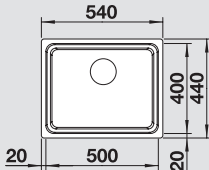
- BLANCO ETAGON sfoggia la funzionalità di un'area di lavaggio dal minimo ingombro
- Lo spazioso lavello monovasca è in grado di contenere comodamente le teglie da forno, che possono essere così tenute a bagno e lavate con comodità
- Barre ETAGON in acciaio inox in dotazione

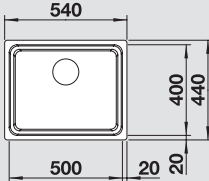
VASCHE  
INOX

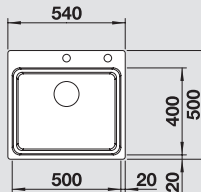
BLANCO ETAGON 500 Acciaio Inox 18/10	Incasso	Dettagli Colore / Finitura	Codice	Euro	60 cm base sottolavello
 <p>Scarico InFino manuale integrato di serie</p>	 <p>Sottotop</p>	<p><b>BLANCO ETAGON 500-U</b></p> <p>Confezione in cartone</p> <p>Dimensioni intaglio: 500x400 mm - R 35 Profondità vasca: 190 mm</p> <p><b>Fornitura:</b> vasca con piletta da 3½", tappo a cestello InFino, sifone e coppia di barre in acciaio inox</p>	1521841	772,00	
 <p>Scarico InFino manuale integrato di serie</p>	 <p>Sopratop e filotop</p>	<p><b>BLANCO ETAGON 500-IF</b></p> <p>Confezione in cartone</p> <p>Dimensioni intaglio per incasso sopratop: 530x430 mm - R 15 Profondità vasca: 190 mm</p> <p><b>Fornitura:</b> vasca con piletta da 3½", tappo a cestello InFino, sifone e coppia di barre in acciaio inox</p>	1521840	862,00	
 <p>Scarico InFino e kit saltarello con comando sintetico cromato di serie</p>	 <p>Sopratop e filotop</p>	<p><b>BLANCO ETAGON 500-IF/A</b></p> <p>Confezione in cartone</p> <p>Dimensioni intaglio per incasso sopratop: 530x490 mm - R 15 Profondità vasca: 190 mm</p> <p><b>Fornitura:</b> vasca con piletta da 3½", tappo a cestello InFino, sifone, coppia di barre in acciaio inox e saltarello con comando in materiale sintetico cromato</p>	1521748	1.078,00	

Per i modelli -IF è necessario prevedere uno scanco nello spessore del top per l'alloggiamento del troppopieno (v. pag. 260)

Per l'installazione dei modelli -IF e -IF/A su top da 15 mm a 30 mm di spessore, ordinare l'apposito kit di ganci (v. pag. 258)

## BLANCO UNIT con BLANCO ETAGON

## Accessori opzionali

Miscelatore  
BLANCO PANERA-S



Cod. 1521547  
Euro 1.832,00

Raccolta differenziata  
BLANCO SELECT II 60/3 Orga



Cod. 1526209  
Euro 703,00

Barre ETAGON  
in acciaio inox



COMPRESSE

Tagliere in  
legno multistrato



Cod. 1230700  
Euro 352,00

Vaschetta forata  
in acciaio inox



Cod. 1231396  
Euro 222,00









# BLANCO ETAGON 700-U BLANCO ETAGON 700-IF BLANCO ETAGON 700-IF/A

Acciaio Inox 18/10

## Un lavello, tre livelli.

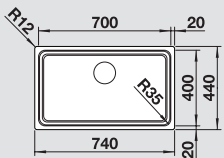
- BLANCO ETAGON 700 sfoggia ancora più funzionalità grazie alla sua ampia e versatile area di lavaggio
- Lo spazioso lavello monovasca è in grado di contenere comodamente anche le pentole più voluminose, che possono essere così tenute a bagno e lavate con comodità
- Barre ETAGON in acciaio inox in dotazione

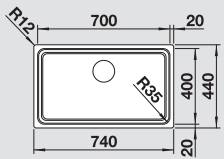

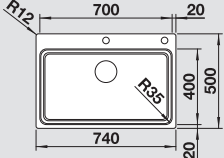
BLANCO ETAGON 700 Acciaio Inox 18/10	Incasto	Dettagli Colore / Finitura	Codice	Euro	80 cm base sottolavello
 <p>Scarico InFino manuale integrato di serie</p>	 <p>Sottotop</p>	<p><b>BLANCO ETAGON 700-U</b></p> <p>Confezione in cartone</p> <p>Dimensioni intaglio per incasso: 700x400 mm - R 35 Profondità vasca: 190 mm</p> <p><b>Fornitura:</b> vasca con piletta da 3½", tappo a cestello InFino, kit di montaggio, sifone e coppia di barre in acciaio inox</p>	1524270	919,00	
 <p>Scarico InFino manuale integrato di serie</p>	 <p>Sopratop e filotop</p>	<p><b>BLANCO ETAGON 700-IF</b></p> <p>Confezione in cartone</p> <p>Dimensioni intaglio per incasso sopratop: 730x430 mm - R 15 Profondità vasca: 190 mm</p> <p><b>Fornitura:</b> vasca con piletta da 3½", tappo a cestello InFino, sifone e coppia di barre in acciaio inox</p>	1524272	1.009,00	
 <p>Scarico InFino e kit saltarello con comando sintetico cromato di serie</p>	 <p>Sopratop e filotop</p>	<p><b>BLANCO ETAGON 700-IF/A</b></p> <p>Confezione in cartone</p> <p>Dimensioni intaglio per incasso sopratop: 730x490 mm - R 15 Profondità vasca: 190 mm</p> <p><b>Fornitura:</b> vasca con piletta da 3½", tappo a cestello InFino, sifone, coppia di barre in acciaio inox e saltarello con comando in materiale sintetico cromato</p>	1524274	1.248,00	

Per i modelli -IF è necessario prevedere uno scanso nello spessore del top per l'alloggiamento del troppopieno (v. pag. 264)

Per l'installazione dei modelli -IF e -IF/A su top da 15 mm a 30 mm di spessore, ordinare l'apposito kit di ganci (v. pag. 258)

### BLANCO UNIT con BLANCO ETAGON

### Accessori opzionali

Miscelatore  
BLANCO PANERA-S



Cod. 1521547  
Euro 1.832,00

Raccolta differenziata  
BLANCO SELECT II 60/3 Orga



Cod. 1526209  
Euro 703,00

Barre ETAGON  
in acciaio inox



COMPRESSE

Tagliere  
in bambù



Cod. 1239449  
Euro 136,00

NUOVO

Gocciolatoio  
sintetico nero

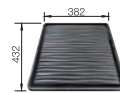

Cod. 1230734  
Euro 85,00

Vaschetta forata  
in acciaio inox



Cod. 1231396  
Euro 222,00

# BLANCO ANDANO-U, -IF, -IF/A

Sinfonia in acciaio.

VASCHE  
INOX



Vasca: BLANCO ANDANO 500-IF/A  
Miscelatore: BLANCO LANORA-S



BLANCO ANDANO  
180-U / -IF



BLANCO ANDANO  
340-U / -IF



BLANCO ANDANO  
400-U / -IF



BLANCO ANDANO  
450-U / -IF



BLANCO ANDANO  
500-U / -IF



BLANCO ANDANO  
700-U / -IF



BLANCO ANDANO 400-IF/A



BLANCO ANDANO 500-IF/A



BLANCO ANDANO 700-IF/A





BLANCO ANDANO -U, -IF e -IF/A è la famiglia di vasche che si distingue per la sua esclusività. I modelli -IF e -IF/A sono caratterizzati da un bordo perimetrale smussato e sagomato, e sono incassabili sia, sopratop, sia a filotop.

Le vasche e i lavelli BLANCO ANDANO si caratterizzano per un'elevata flessibilità e praticità, permettendo infinite possibilità di abbinamenti e combinazioni tra i diversi modelli.



La raffinata eleganza di BLANCO ANDANO si evince anche dalla fornitura: lo scarico InFino è incluso di serie, così come il comando saltarello PushControl per i modelli con fascia miscelatore (-IF/A).



BLANCO ANDANO  
340/180-U / -IF



BLANCO ANDANO  
340/340-U / -IF



BLANCO ANDANO  
400/400-U / -IF



BLANCO ANDANO  
500/180-U



BLANCO ANDANO  
340/180-IF/A



BLANCO ANDANO  
340/340-IF/A



BLANCO ANDANO  
400/400-IF/A



**BLANCO ANDANO 180**  
Acciaio Inox 18/10



Scarico InFino  
manuale integrato  
di serie

**Incasso**

**Dettagli**  
Colore / Finitura

**Codice**

**Euro**



Sottotop

**BLANCO ANDANO 180-U**

Confezione in cartone

1518301

425,00

Dimensioni intaglio: 180x400 mm - R 22  
Raggio interno: 22 mm  
Raggio fondo vasca: 10 mm  
Profondità vasca: 130 mm

**Fornitura:** vasca con piletta da 3½", sifone, tappo a cestello InFino e kit di montaggio

**30** cm base  
sottolavello

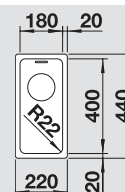

Scarico InFino  
manuale integrato  
di serie



Sopratop  
e filotop

**BLANCO ANDANO 180-IF**

Confezione in cartone

1518303

511,00

Dimensioni intaglio per incasso sopratop: 210x430 mm - R 15  
Raggio interno: 22 mm  
Raggio fondo vasca: 10 mm  
Raggio esterno: 12 mm  
Profondità vasca: 130 mm

**Fornitura:** vasca con piletta da 3½", sifone e tappo a cestello InFino

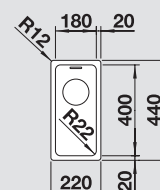

**BLANCO ANDANO 340**  
Acciaio Inox 18/10



Scarico InFino  
manuale integrato  
di serie



Sottotop

**BLANCO ANDANO 340-U**

Confezione in cartone

1518305

459,00

Dimensioni intaglio: 340x400 mm - R 22  
Raggio interno: 22 mm  
Raggio fondo vasca: 10 mm  
Profondità vasca: 190 mm

**Fornitura:** vasca con piletta da 3½", sifone, tappo a cestello InFino e kit di montaggio

**45** cm base  
sottolavello

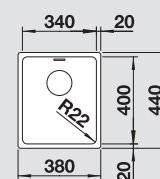

Scarico InFino  
manuale integrato  
di serie



Sopratop  
e filotop

**BLANCO ANDANO 340-IF**

Confezione in cartone

1518307

538,00

Dimensioni intaglio per incasso sopratop: 370x430 mm - R 15  
Raggio interno: 22 mm  
Raggio fondo vasca: 10 mm  
Raggio esterno: 12 mm  
Profondità vasca: 190 mm

**Fornitura:** vasca con piletta da 3½", sifone e tappo a cestello InFino

**40** cm base  
sottolavello

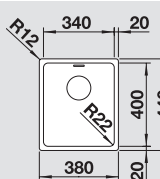

**BLANCO UNIT con BLANCO ANDANO**

**Accessori opzionali**

Miscelatore  
BLANCO VONDA, cromato



Cod. 1518434  
Euro 652,00

Raccolta differenziata  
BLANCO FLEXON II Low 90/4



Cod. 1521475  
Euro 379,00

Dissipatore BLANCO  
FWD Max



Cod. 1526648  
Euro 1.248,00

Tagliere  
in bambù



Cod. 1239449  
Euro 136,00

Gocciolatoio  
sintetico nero

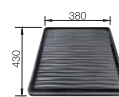

Cod. 1230734  
Euro 85,00



**BLANCO ANDANO 400**  
Acciaio Inox 18/10

**Incasso**

**Dettagli**  
Colore / Finitura

**Codice**

**Euro**

**60** cm base  
sottolavello



**BLANCO ANDANO 400-U**

Confezione in cartone

1518309

511,00

Dimensioni intaglio: 400x400 mm - R 22

Raggio interno: 22 mm

Raggio fondo vasca: 10 mm

Profondità vasca: 190 mm

**Fornitura:** vasca con piletta da 3½", sifone, tappo a cestello InFino e kit di montaggio

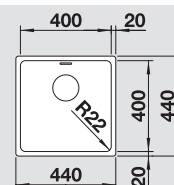

Scarico InFino  
manuale integrato  
di serie



**BLANCO ANDANO 400-IF**

Confezione in cartone

1518311

596,00

Dimensioni intaglio per incasso sopratop: 430x430 mm - R 15

Raggio interno: 22 mm

Raggio fondo vasca: 10 mm

Raggio esterno: 12 mm

Profondità vasca: 190 mm

**Fornitura:** vasca con piletta da 3½", sifone e tappo a cestello InFino

**45** cm base  
sottolavello

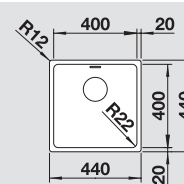

Scarico InFino  
manuale integrato  
di serie



**BLANCO ANDANO 400-IF/A**

Confezione in cartone

1519555

811,00

Dimensioni intaglio per incasso sopratop: 430x490 mm - R 15

Raggio interno: 22 mm

Raggio fondo vasca: 10 mm

Raggio esterno: 12 mm

Profondità vasca: 190 mm

**Fornitura:** vasca con piletta da 3½", sifone, tappo a cestello InFino e saltarello **con comando PushControl**

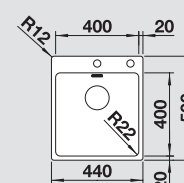

Scarico InFino a saltarello  
integrato con comando  
PushControl di serie

**N.B.:** per tutti i modelli BLANCO ANDANO-IF/A, non è possibile installare il miscelatore BLANCO ELOSOCPE-F II direttamente dietro il troppopieno.

**N.B.:** La confezione in cartone include sia la piletta, sia il sifone; la confezione in cartone perimetrale include la sola piletta.

I lavelli contrassegnati con il simbolo non possono essere montati a "inizio/fine composizione" nella base sottolavello indicata; possono essere invece facilmente inseriti in una base di misura superiore.

Per installazione dei modelli -IF e -IF/A su top di altezza inferiore ai 30 mm e fino a 15 mm di spessore, usare set di ganci cod. 1223742 (v. pag. 258)

**Accessori opzionali**

**Barre multiuso**  
in acciaio inox



Cod. 1235906  
Euro 205,00

**Comandi saltarello**  
disponibili



vedere pagina 285

**Vaschetta forata**  
in acciaio inox



Cod. 1227692  
Euro 136,00

**Tagliere in cristallo**  
satinato silver

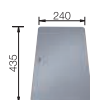

Cod. 1227697  
Euro 205,00

**Tagliere in**  
legno multistrato



Cod. 1230700  
Euro 352,00

**Griglia pieghevole**  
multifunzione

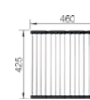

Cod. 1238482  
Euro 181,00

**BLANCO ANDANO 450**  
Acciaio Inox 18/10

**Incasso**

**Dettagli**  
Colore / Finitura

**Codice**

**Euro**

**60** cm base  
sottolavello



**BLANCO ANDANO 450-U**

Confezione in cartone

1519373

567,00

Dimensioni intaglio: 450x400 mm - R 22  
Raggio interno: 22 mm  
Raggio fondo vasca: 10 mm  
Profondità vasca: 190 mm

**Fornitura:** vasca con piletta da 3 1/2", sifone, tappo a cestello InFino e kit di montaggio



Scarico InFino  
manuale integrato  
di serie

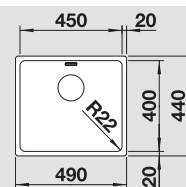

**BLANCO ANDANO 450-IF**

Confezione in cartone

1519375

652,00

Dimensioni intaglio per incasso sopratope: 480x430 mm - R 15  
Raggio interno: 22 mm  
Raggio fondo vasca: 10 mm  
Raggio esterno: 12 mm  
Profondità vasca: 190 mm

**Fornitura:** vasca con piletta da 3 1/2", sifone e tappo a cestello InFino



Scarico InFino  
manuale integrato  
di serie

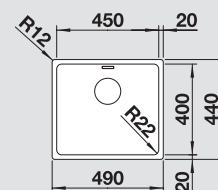

BLANCO ANDANO 500-IF

**BLANCO UNIT con BLANCO ANDANO**

**Accessori opzionali**

Miscelatore  
BLANCO VONDA, cromato



Cod. 1518434  
Euro 652,00

Raccolta differenziata  
BLANCO FLEXON II Low 90/4



Cod. 1521475  
Euro 379,00

Dissipatore BLANCO  
FWD Max



Cod. 1526648  
Euro 1.248,00

**NUOVO**

Tagliere  
in bambù



Cod. 1239449  
Euro 136,00

**NUOVO**

Gocciolatoio  
sintetico nero

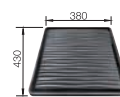

Cod. 1230734  
Euro 85,00

**BLANCO ANDANO 500**  
Acciaio Inox 18/10

**Incasso**

**Dettagli**  
Colore / Finitura

**Codice**

**Euro**

**60** cm base  
sottolavello



**BLANCO ANDANO 500-U**

Confezione in cartone

1518313

624,00

Dimensioni intaglio: 500x400 mm - R 22

Raggio interno: 22 mm

Raggio fondo vasca: 10 mm

Profondità vasca: 190 mm

**Fornitura:** vasca con piletta da 3½", sifone, tappo a cestello InFino e kit di montaggio



Scarico InFino  
manuale integrato  
di serie

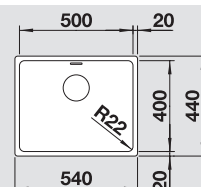

**BLANCO ANDANO 500-IF**

Confezione in cartone

1518315

703,00

Dimensioni intaglio per incasso sopratop: 530x430 mm - R 15

Raggio interno: 22 mm

Raggio fondo vasca: 10 mm

Raggio esterno: 12 mm

Profondità vasca: 190 mm

**Fornitura:** vasca con piletta da 3½", sifone e tappo a cestello InFino



Scarico InFino  
manuale integrato  
di serie

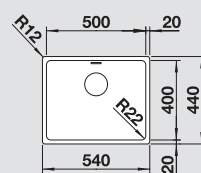

**BLANCO ANDANO 500-IF/A**

Confezione in cartone

1519556

970,00

Dimensioni intaglio per incasso sopratop: 530x490 mm - R 15

Raggio interno: 22 mm

Raggio fondo vasca: 10 mm

Raggio esterno: 12 mm

Profondità vasca: 190 mm

**Fornitura:** vasca con piletta da 3½", sifone, tappo a cestello InFino e saltarello **con comando PushControl**



Scarico InFino a saltarello  
integrato con comando  
PushControl di serie

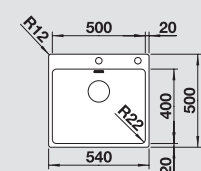

**N.B.:** per tutti i modelli BLANCO ANDANO-IF/A, non è possibile installare il miscelatore BLANCO ELOSOCPE-F II direttamente dietro il troppopieno.

**N.B.:** La confezione in cartone include sia la piletta, sia il sifone; la confezione in cartone perimetrale include la sola piletta.

I lavelli contrassegnati con il simbolo non possono essere montati a "inizio/fine composizione" nella base sottolavello indicata; possono essere invece facilmente inseriti in una base di misura superiore.

Per installazione dei modelli -IF e -IF/A su top di altezza inferiore ai 30 mm e fino a 15 mm di spessore, usare set di ganci cod. 1223742 (v. pag. 258)

**Accessori opzionali**

**Barre multiuso**  
in acciaio inox



Cod. 1235906  
Euro 205,00

**Comandi saltarello**  
disponibili



vedere pagina 285

**Vaschetta forata**  
in acciaio inox



Cod. 1227692  
Euro 136,00

**Tagliere in cristallo**  
satinato silver

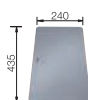

Cod. 1227697  
Euro 205,00

**Tagliere in**  
legno multistrato



Cod. 1230700  
Euro 352,00

**Griglia pieghevole**  
multifunzione

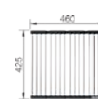

Cod. 1238482  
Euro 181,00

**BLANCO ANDANO 700**  
Acciaio Inox 18/10

**Incasso**

**Dettagli**  
Colore / Finitura

**Codice**

**Euro**

**80** cm base  
sottolavello



**BLANCO ANDANO 700-U**

Confezione in cartone

1518614

681,00

Dimensioni intaglio: 700x400 mm - R 22  
Raggio interno: 22 mm  
Raggio fondo vasca: 10 mm  
Profondità vasca: 190 mm

**Fornitura:** vasca con piletta da 3½", sifone, tappo a cestello InFino e kit di montaggio



Scarico InFino  
manuale integrato  
di serie

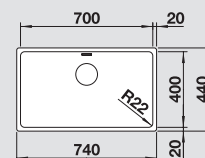

**BLANCO ANDANO 700-IF**

Confezione in cartone

1518616

760,00

Dimensioni intaglio per incasso soprato: 730x430 mm - R 15  
Raggio interno: 22 mm  
Raggio fondo vasca: 10 mm  
Raggio esterno: 12 mm  
Profondità vasca: 190 mm

**Fornitura:** vasca con piletta da 3½", sifone e tappo a cestello InFino



Scarico InFino  
manuale integrato  
di serie

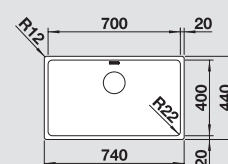

**BLANCO ANDANO 700-IF/A**

Confezione in cartone

1519557

1.078,00

Dimensioni intaglio per incasso soprato: 730x490 mm - R 15  
Raggio interno: 22 mm  
Raggio fondo vasca: 10 mm  
Raggio esterno: 12 mm  
Profondità vasca: 190 mm

**Fornitura:** vasca con piletta da 3½", sifone, tappo a cestello InFino e saltarello con **comando PushControl**



Scarico InFino a saltarello  
integrato con comando  
PushControl di serie

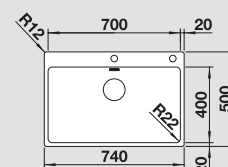

**BLANCO UNIT con BLANCO ANDANO**

**Accessori opzionali**

Miscelatore  
BLANCO VONDA, cromato



Cod. 1518434  
Euro 652,00

Raccolta differenziata  
BLANCO FLEXON II Low 90/4



Cod. 1521475  
Euro 379,00

Dissipatore BLANCO  
FWD Max



Cod. 1526648  
Euro 1.248,00

**NUOVO**

Tagliere  
in bambù



Cod. 1239449  
Euro 136,00

**NUOVO**

Gocciolatoio  
sintetico nero

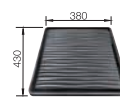

Cod. 1230734  
Euro 85,00



**BLANCO ANDANO 340/180**  
Acciaio Inox 18/10

Incasso

Dettagli  
Colore / Finitura

Codice

Euro

**75\*/80** cm base  
sottolavello



**BLANCO ANDANO 340/180-U**

Vasca grande a DX - Conf. in cartone  
Vasca grande a SX - Conf. in cartone

1518317 970,00  
1518321 970,00

Dimensioni intaglio: 545x400 mm - R 22  
Raggio interno: 22 mm  
Raggio fondo vasca: 10 mm  
Profondità vasche: 190/130 mm

**Fornitura:** vasche con piletta da 3½", sifone, tappo a cestello InFino e kit di montaggio

**\*Adatto a basi sottolavello da 75 cm**

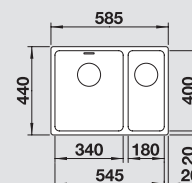

Scarico InFino  
manuale integrato  
di serie



**60** cm base  
sottolavello



**BLANCO ANDANO 340/180-IF**

Vasca grande a DX - Conf. in cartone  
Vasca grande a SX - Conf. in cartone

1518319 1.117,00  
1518323 1.117,00

Dimensioni intaglio per incasso sopratop: 575x430 mm - R 15  
Raggio interno: 22 mm  
Raggio fondo vasca: 10 mm  
Raggio esterno: 12 mm  
Profondità vasche: 190/130 mm

**Fornitura:** vasche con piletta da 3½", sifone e tappo a cestello InFino

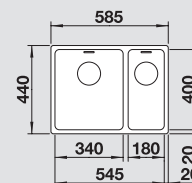

Scarico InFino  
manuale integrato  
di serie



**BLANCO ANDANO 340/180-IF/A**

Confezione in cartone

1519558 1.366,00

Dimensioni intaglio per incasso sopratop: 575x490 mm - R 15  
Raggio interno: 22 mm  
Raggio fondo vasca: 10 mm  
Raggio esterno: 12 mm  
Profondità vasche: 190/130 mm

**Fornitura:** vasche con piletta da 3½", sifone, tappo a cestello InFino e saltarello **con comando PushControl** per vasca principale

**Disponibile solo con vasca grande a destra**

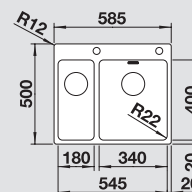

Scarico InFino a saltarello  
integrato con comando  
PushControl di serie



VASCHE  
INOX

**N.B.:** per tutti i modelli BLANCO ANDANO-IF/A, non è possibile installare il miscelatore BLANCO ELOSOCPE-F II direttamente dietro il troppopieno.

**N.B.:** La confezione in cartone include sia la piletta, sia il sifone; la confezione in cartone perimetrale include la sola piletta.

I lavelli contrassegnati con il simbolo non possono essere montati a "inizio/fine composizione" nella base sottolavello indicata; possono essere invece facilmente inseriti in una base di misura superiore.

Per installazione dei modelli -IF e -IF/A su top di altezza inferiore ai 30 mm e fino a 15 mm di spessore, usare set di ganci cod. 1223742 (v. pag. 258)

**Accessori opzionali**

Barre multiuso  
in acciaio inox



Cod. 1235906  
Euro 205,00

Comandi saltarello  
disponibili



vedere pagina 285

Vaschetta forata  
in acciaio inox



Cod. 1227692  
Euro 136,00

Tagliere in cristallo  
satinato silver



Cod. 1227697  
Euro 205,00

Tagliere in  
legno multistrato



Cod. 1230700  
Euro 352,00

Griglia pieghevole  
multifunzione



Cod. 1238482  
Euro 181,00

**BLANCO ANDANO 340/340**  
Acciaio Inox 18/10

**Incasso**

**Dettagli**  
Colore / Finitura

**Codice**

**Euro**

**80** cm base  
sottolavello



**BLANCO ANDANO 340/340-U**

Confezione in cartone

1520824

992,00

Dimensioni intaglio: 705x400 mm - R 22  
Raggio interno: 22 mm  
Raggio fondo vasca: 10 mm  
Profondità vasche: 190 mm

**Fornitura:** vasche con piletta da 3½", sifone, tappo a cestello InFino e kit di montaggio



Scarico InFino  
manuale integrato  
di serie

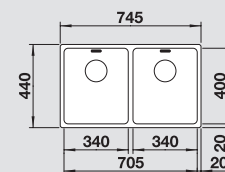

**BLANCO ANDANO 340/340-IF**

Confezione in cartone

1520830

1.146,00

Dimensioni intaglio per incasso sopra-top: 735x430 mm - R 15  
Raggio interno: 22 mm  
Raggio fondo vasca: 10 mm  
Raggio esterno: 12 mm  
Profondità vasche: 190 mm

**Fornitura:** vasche con piletta da 3½", sifone e tappo a cestello InFino



Scarico InFino  
manuale integrato  
di serie

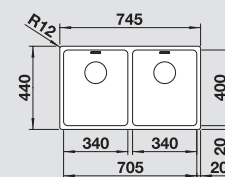

**BLANCO ANDANO 340/340-IF/A**

Confezione in cartone

1520832

1.452,00

Dimensioni intaglio per incasso sopra-top: 735x490 mm - R 15  
Raggio interno: 22 mm  
Raggio fondo vasca: 10 mm  
Raggio esterno: 12 mm  
Profondità vasche: 190/190 mm

**Fornitura:** vasche con piletta da 3½", sifone, tappo a cestello InFino e saltarello con comando PushControl per una vasca



Scarico InFino a saltarello  
integrato con comando  
PushControl di serie

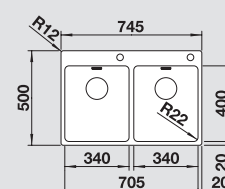

**BLANCO UNIT con BLANCO ANDANO**

**Accessori opzionali**

Miscelatore  
BLANCO VONDA, cromato



Cod. 1518434  
Euro 652,00

Raccolta differenziata  
BLANCO FLEXON II Low 90/4



Cod. 1521475  
Euro 379,00

Dissipatore BLANCO  
FWD Max



Cod. 1526648  
Euro 1.248,00

**NUOVO**

Tagliere  
in bambù



Cod. 1239449  
Euro 136,00

**NUOVO**

Gocciolatoio  
sintetico nero

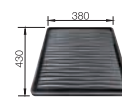

Cod. 1230734  
Euro 85,00

**BLANCO ANDANO 400/400**  
Acciaio Inox 18/10

Incasso

Dettagli  
Colore / Finitura

Codice

Euro

**100** cm base  
sottolavello



**BLANCO ANDANO 400/400-U**

Confezione in cartone

1518325

1.021,00

Dimensioni intaglio: 825x400 mm - R 22

Raggio interno: 22 mm

Raggio fondo vasca: 10 mm

Profondità vasche: 190 mm

**Fornitura:** vasche con piletta da 3½", sifone, tappo a cestello InFino e kit di montaggio

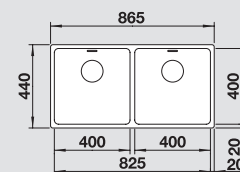

Scarico InFino  
manuale integrato  
di serie

**90** cm base  
sottolavello



**BLANCO ANDANO 400/400-IF**

Confezione in cartone

1518327

1.173,00

Dimensioni intaglio per incasso sopratop: 855x430 mm - R 15

Raggio interno: 22 mm

Raggio fondo vasca: 10 mm

Raggio esterno: 12 mm

Profondità vasche: 190 mm

**Fornitura:** vasche con piletta da 3½", sifone e tappo a cestello InFino

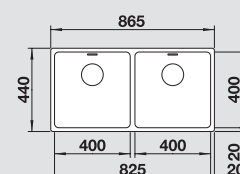

Scarico InFino  
manuale integrato  
di serie



**BLANCO ANDANO 400/400-IF/A**

Confezione in cartone

1519559

1.532,00

Dimensioni intaglio per incasso sopratop: 855x490 mm - R 15

Raggio interno: 22 mm

Raggio fondo vasca: 10 mm

Raggio esterno: 12 mm

Profondità vasche: 190/190 mm

**Fornitura:** vasche con piletta da 3½", sifone, tappo a cestello InFino e saltarello **con comando PushControl** per una vasca

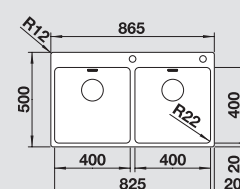

Scarico InFino e kit  
saltarello con comando  
PushControl di serie

VASCHE  
INOX

**N.B.:** per tutti i modelli BLANCO ANDANO-IF/A, non è possibile installare il miscelatore BLANCO ELOSOCPE-F II direttamente dietro il troppopieno.

**N.B.:** La confezione in cartone include sia la piletta, sia il sifone; la confezione in cartone perimetrale include la sola piletta.

I lavelli contrassegnati con il simbolo  non possono essere montati a "inizio/fine composizione" nella base sottolavello indicata; possono essere invece facilmente inseriti in una base di misura superiore.

Per installazione dei modelli -IF e -IF/A su top di altezza inferiore ai 30 mm e fino a 15 mm di spessore, usare set di ganci cod. 1223742 (v. pag. 258)

**Accessori opzionali**

Barre multiuso  
in acciaio inox



Cod. 1235906  
Euro 205,00

Comandi saltarello  
disponibili



vedere pagina 285

Vaschetta forata  
in acciaio inox



Cod. 1227692  
Euro 136,00

Tagliere in cristallo  
satinato silver



Cod. 1227697  
Euro 205,00

Tagliere in  
legno multistrato



Cod. 1230700  
Euro 352,00

Griglia pieghevole  
multifunzione



Cod. 1238482  
Euro 181,00

**BLANCO ANDANO 500/180-U**  
Acciaio Inox 18/10

**Incasso**

**Dettagli**  
Colore / Finitura

**Codice**

**Euro**

**80** cm base  
sottolavello



Sottotop

Vasca grande a DX - Conf. in cartone  
Vasca grande a SX - Conf. in cartone

1520826 1.009,00  
1520828 1.009,00

Dimensioni intaglio: 705x400 mm - R 22  
Raggio interno: 22 mm  
Raggio fondo vasca: 10 mm  
Profondità vasche: 190/130 mm

**Fornitura:** vasche con piletta da 3½", sifone, tappo a cestello InFino e kit di montaggio



Scarico InFino  
manuale integrato  
di serie

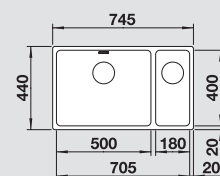

VASCHE  
INOX



**BLANCO UNIT con BLANCO ANDANO**

**Accessori opzionali**

Miscelatore  
BLANCO VONDA, cromato



Cod. 1518434  
Euro 652,00

Raccolta differenziata  
BLANCO FLEXON II Low 90/4



Cod. 1521475  
Euro 379,00

Dissipatore BLANCO  
FWD Max



Cod. 1526648  
Euro 1.248,00

**NUOVO**

Tagliere  
in bambù



Cod. 1239449  
Euro 136,00

**NUOVO**

Gocciolatoio  
sintetico nero

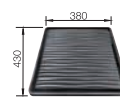

Cod. 1230734  
Euro 85,00





# BLANCO ANDANO XL 6 S-IF Compact BLANCO ANDANO XL 6 S-IF

Acciaio Inox 18/10

## Sinfonia in acciaio inox.

- Design elegante e contemporaneo con elementi multifunzionali
- Il design compatto del gocciolatoio assicura la massima comodità anche in spazi ridotti
- Fascia miscelatore laterale, ideale anche per installazione sottofinestra
- L'elegante tagliere in vetro satinato blu (opzionale) scorre sulla quasi totalità della superficie del livello

BLANCO ANDANO XL 6 S Compact

### BLANCO ANDANO XL 6 S-IF Compact Acciaio Inox 18/10

Incasso	Dettagli Colore / Finitura	Codice	Euro
---------	-------------------------------	--------	------



Sopratop  
e filtop

Vasca DX - Confezione in cartone  
Vasca SX - Confezione in cartone

1521013 1.588,00  
1521014 1.588,00

Dimensioni intaglio per incasso sopratop: 836x476 mm - R 15 mm  
Raggio interno: 22 mm  
Raggio fondo vasca: 10 mm  
Profondità vasca: 210 mm

**Fornitura:** vasca con piletta da 3½", sifone, tappo a cestello InFino, saltarello cromato e vaschetta forata acciaio inox



Scarico InFino e kit saltarello con comando cromato girevole di serie

**60** cm base sottolavello

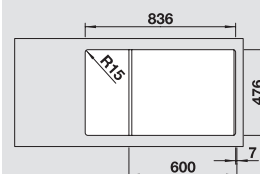
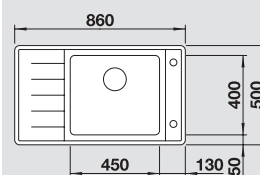

### BLANCO ANDANO XL 6 S-IF Acciaio Inox 18/10

Incasso	Dettagli Colore / Finitura	Codice	Euro
---------	-------------------------------	--------	------



Sopratop  
e filtop

Vasca DX - Confezione in cartone  
Vasca SX - Confezione in cartone

1521011 1.645,00  
1521012 1.645,00

Dimensioni intaglio per incasso sopratop: 976x476 mm - R 15 mm  
Raggio interno: 22 mm  
Raggio fondo vasca: 10 mm  
Profondità vasca: 210 mm

**Fornitura:** vasca con piletta da 3½", sifone, tappo a cestello InFino, saltarello cromato e vaschetta forata acciaio inox



Scarico InFino e kit saltarello con comando cromato girevole di serie

**60** cm base sottolavello

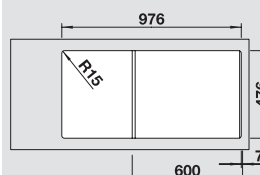
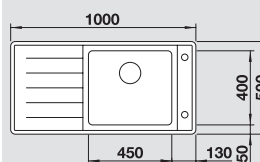

I lavelli contrassegnati con il simbolo non possono essere montati a "inizio/fine composizione" nella base sottolavello indicata; possono essere invece facilmente inseriti in una base di misura superiore.

## BLANCO UNIT con BLANCO ANDANO

## Accessori opzionali

Miscelatore  
BLANCO VONDA



Cod. 1518434  
Euro 652,00

Raccolta differenziata  
BLANCO FLEXON II 60/3



Cod. 1521472  
Euro 312,00

Barre multiuso  
in acciaio inox



Cod. 1235906  
Euro 205,00

Vaschetta forata  
in acciaio inox



COMPRESA

Tagliere in  
vetro satinato blu



Cod. 1232846  
Euro 340,00

# BLANCO SOLIS -U, -IF, -IF/A

Funzionalità e design in armonia.

VASCHE  
INOX



Vasca: BLANCO SOLIS 340/180-IF/A



BLANCO SOLIS 180-U  
BLANCO SOLIS 180-IF



BLANCO SOLIS 340-U  
BLANCO SOLIS 340-IF



BLANCO SOLIS 400-U  
BLANCO SOLIS 400-IF



BLANCO SOLIS 450-U  
BLANCO SOLIS 450-IF



BLANCO SOLIS 500-U  
BLANCO SOLIS 500-IF



BLANCO SOLIS 700-U  
BLANCO SOLIS 700-IF



BLANCO SOLIS 340/180-U  
BLANCO SOLIS 340/180-IF



BLANCO SOLIS 400-IF/A



BLANCO SOLIS 500-IF/A



BLANCO SOLIS 700-IF/A



BLANCO SOLIS 340/180-IF/A



La famiglia di lavelli BLANCO SOLIS, grazie all'interazione di elementi funzionali ed estetici, regala una perfetta armonia in cucina. Disponibili sia per incasso sottotop (-U), sia a filotop e sopratop con effetto semifilo (-IF), i lavelli BLANCO SOLIS offrono una fornitura di serie di alta qualità il troppopieno C-Overflow® e il sistema di scarico InFino, elegantemente integrato e di facile manutenzione, più i pratici accessori (opzionali) che ne aumentano la produttività. Nella versione -IF/A (con fascia miscelatore posteriore) è compreso lo scarico a saltarello con comando PushControl.



BLANCO SOLIS 500-U: grande capacità e fondo completamente utilizzabile grazie al raggio ridotto del fondo vasca.











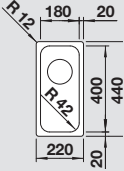

Alta qualità BLANCO: acciaio inox con finitura omogenea dai contorni definiti e diverse misure, per tutti i metodi di installazione e la massima libertà di progettazione.



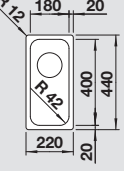

BLANCO SOLIS per incasso sottotop (-U) offre semplicità di pulizia unita a un'estetica senza pari.

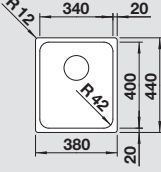

BLANCO SOLIS 180 Acciaio Inox 18/10	Incasto	Dettagli Colore / Finitura	Codice	Euro	30 cm base sottolavello
  Scarico InFino manuale integrato di serie	 Sottotop	<b>BLANCO SOLIS 180-U</b> Confezione in cartone	1526113	318,00	
		Dimensioni intaglio: 180x400 mm - R 42 Profondità vasca: 125 mm  <b>Fornitura:</b> vasca con piletta da 3½", sifone e tappo a cestello InFino e kit di montaggio			
  Scarico InFino manuale integrato di serie	 Sopratop e filotop	<b>BLANCO SOLIS 180-IF</b> Confezione in cartone	1526114	386,00	
		Dimensioni intaglio per incasso sopratop: 210x430 mm - R 15 Profondità vasca: 125 mm  <b>Fornitura:</b> vasca con piletta da 3½", sifone e tappo a cestello InFino			

BLANCO SOLIS 340 Acciaio Inox 18/10	Incasto	Dettagli Colore / Finitura	Codice	Euro	45 cm base sottolavello
  Scarico InFino manuale integrato di serie	 Sottotop	<b>BLANCO SOLIS 340-U</b> Confezione in cartone	1526115	340,00	
		Dimensioni intaglio: 340x400 mm - R 42 Profondità vasca: 185 mm  <b>Fornitura:</b> vasca con piletta da 3½", sifone e tappo a cestello InFino e kit di montaggio			

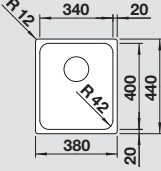
BLANCO SOLIS 340-IF	Incasto	Dettagli Colore / Finitura	Codice	Euro	40 cm base sottolavello
  Scarico InFino manuale integrato di serie	 Sopratop e filotop	<b>BLANCO SOLIS 340-IF</b> Confezione in cartone	1526116	408,00	
		Dimensioni intaglio per incasso sopratop: 370x430 mm - R 15 Profondità vasca: 185 mm  <b>Fornitura:</b> vasca con piletta da 3½", sifone e tappo a cestello InFino			

**BLANCO UNIT con BLANCO SOLIS**

**Accessori opzionali**

Miscelatore  
BLANCO LANORA-S



Cod. 1523123  
Euro 555,00

Raccolta differenziata  
BLANCO FLEXON II Low 60/4



Cod. 1526644  
Euro 284,00

Dissipatore BLANCO  
FWD Medium



Cod. 1526647  
Euro 965,00

Tagliere  
in bambù



Cod. 1239449  
Euro 136,00

Gocciolatoio  
sintetico nero

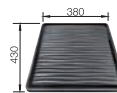

Cod. 1230734  
Euro 85,00



**BLANCO SOLIS 400**  
Acciaio Inox 18/10

**Incasso**

**Dettagli**  
Colore / Finitura

**Codice**

**Euro**

**60** cm base  
sottolavello



**BLANCO SOLIS 400-U**

Confezione in cartone

1526117

386,00

Dimensioni intaglio: 400x400 mm - R 42  
Profondità vasca: 185 mm

**Fornitura:** vasca con piletta da 3½", sifone e tappo a cestello InFino e kit di montaggio



Scarico InFino  
manuale integrato  
di serie

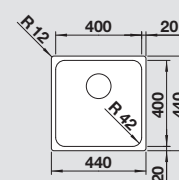

**BLANCO SOLIS 400-IF**

Confezione in cartone

1526118

454,00

Dimensioni intaglio per incasso sopratop: 430x430 mm - R 15  
Profondità vasca: 185 mm

**Fornitura:** vasca con piletta da 3½", sifone e tappo a cestello InFino



Scarico InFino  
manuale integrato  
di serie

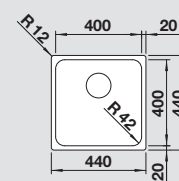

**BLANCO SOLIS 400-IF/A**

Confezione in cartone

1526119

605,00

Dimensioni intaglio per incasso sopratop: 430x490 mm - R 15  
Profondità vasca: 185 mm

**Fornitura:** vasca con piletta da 3½", tappo a cestello InFino, sifone e saltarello **con comando PushControl**



Scarico InFino e kit  
saltarello con comando  
PushControl di serie

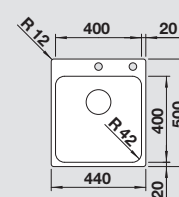

Per i modelli -IF è necessario prevedere uno scasso nello spessore del top per l'alloggiamento del troppopieno (v. pag. 260)

**Accessori opzionali**

**Kit ganci per top di spessore da 15 a 30 mm (10 pz.)**



Cod. 1223742  
Euro 15,00

**Comandi saltarello disponibili**



vedere pagina 269

**Cestello in acciaio inox**



Cod. 1514238  
Euro 130,00

**Barre multiuso in acciaio inox**



Cod. 1235906  
Euro 205,00

**Tagliere in legno multistrato**



Cod. 1230700  
Euro 352,00

**Griglia pieghevole multifunzione**



Cod. 1238482  
Euro 181,00

**BLANCO SOLIS 450**  
Acciaio Inox 18/10

**Incasso**

**Dettagli**  
Colore / Finitura

**Codice**

**Euro**

**60** cm base  
sottolavello



Sottotop

**BLANCO SOLIS 450-U**

Confezione in cartone

1526120

420,00

Dimensioni intaglio: 450x400 mm - R 42  
Profondità vasca: 185 mm

**Fornitura:** vasca con piletta da 3½", sifone e tappo a cestello InFino e kit di montaggio



Scarico InFino  
manuale integrato  
di serie

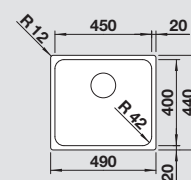

Sopratop  
e filotop

**BLANCO SOLIS 450-IF**

Confezione in cartone

1526121

488,00

Dimensioni intaglio per incasso sopratop: 480x430 mm - R 15  
Profondità vasca: 185 mm

**Fornitura:** vasca con piletta da 3½", sifone e tappo a cestello InFino



Scarico InFino  
manuale integrato  
di serie

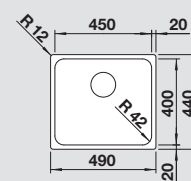

VASCHE  
INOX



**BLANCO UNIT con BLANCO SOLIS**

**Accessori opzionali**

Miscelatore  
**BLANCO LANORA-S**



Cod. 1523123  
Euro 555,00

Raccolta differenziata  
**BLANCO FLEXON II Low 60/4**



Cod. 1526644  
Euro 284,00

Dissipatore **BLANCO FWD Medium**



Cod. 1526647  
Euro 965,00

Tagliere  
in bambù



Cod. 1239449  
Euro 136,00

Gocciolatoio  
sintetico nero

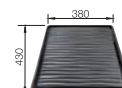

Cod. 1230734  
Euro 85,00

**BLANCO SOLIS 500**  
Acciaio Inox 18/10

**Incasso**

**Dettagli**  
Colore / Finitura

**Codice**

**Euro**

**60** cm base  
sottolavello



**BLANCO SOLIS 500-U**

Confezione in cartone

1526122

465,00

Dimensioni intaglio: 500x400 mm - R 42  
Profondità vasca: 185 mm

**Fornitura:** vasca con piletta da 3½", sifone e tappo a cestello InFino e kit di montaggio



Scarico InFino  
manuale integrato  
di serie

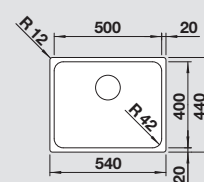

**BLANCO SOLIS 500-IF**

Confezione in cartone

1526123

528,00

Dimensioni intaglio: 530x430 mm - R 15  
Profondità vasca: 185 mm

**Fornitura:** vasca con piletta da 3½", sifone e tappo a cestello InFino



Scarico InFino  
manuale integrato  
di serie

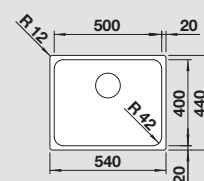

**BLANCO SOLIS 500-IF/A**

Confezione in cartone

1526124

726,00

Dimensioni intaglio per incasso sopratop: 530x490 mm - R 15  
Profondità vasca: 185 mm

**Fornitura:** vasca con piletta da 3½", tappo a cestello InFino, sifone e saltarello con comando **PushControl**



Scarico InFino e kit  
saltarello con comando  
PushControl di serie

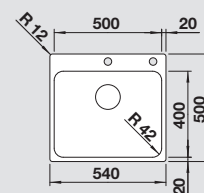

Per i modelli -IF è necessario prevedere uno scanso nello spessore del top per l'alloggiamento del troppopieno (v. pag. 260)

**Accessori opzionali**

**Kit ganci per top di spessore da 15 a 30 mm (10 pz.)**



Cod. 1223742  
Euro 15,00

**Comandi saltarello disponibili**



vedere pagina 269

**Cestello in acciaio inox**



Cod. 1514238  
Euro 130,00

**Barre multiuso in acciaio inox**



Cod. 1235906  
Euro 205,00

**Tagliere in legno multistrato**



Cod. 1230700  
Euro 352,00

**Griglia pieghevole multifunzione**



Cod. 1238482  
Euro 181,00

**BLANCO SOLIS 700**  
Acciaio Inox 18/10



Scarico InFino manuale integrato di serie

**Incasso**

**Dettagli**  
Colore / Finitura

**Codice**

**Euro**

**80** cm base sottolavello



Sottotop

**BLANCO SOLIS 700-U**

Confezione in cartone

1526125

511,00

Dimensioni intaglio: 700x400 mm - R 42  
Profondità vasca: 185 mm

**Fornitura:** vasca con piletta da 3½", sifone e tappo a cestello InFino e kit di montaggio

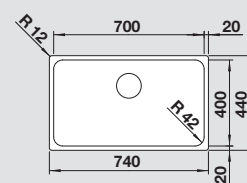

Scarico InFino manuale integrato di serie



Sopratop e filotop

**BLANCO SOLIS 700-IF**

Confezione in cartone

1526126

572,00

Dimensioni intaglio per incasso sopratop: 730x430 mm - R 15  
Profondità vasca: 185 mm

**Fornitura:** vasca con piletta da 3½", sifone e tappo a cestello InFino

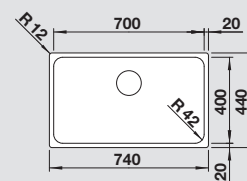

Scarico InFino e kit saltarello con comando PushControl di serie



Sopratop e filotop

**BLANCO SOLIS 700-IF/A**

Confezione in cartone

1526127

806,00

Dimensioni intaglio per incasso sopratop: 730x490 mm - R 15  
Profondità vasca: 185 mm

**Fornitura:** vasca con piletta da 3½", tappo a cestello InFino, sifone e saltarello con comando PushControl

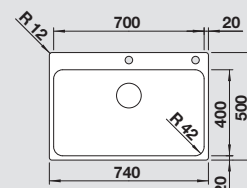

**BLANCO UNIT con BLANCO SOLIS**

Miscelatore  
BLANCO LANORA-S



Cod. 1523123  
Euro 555,00

Raccolta differenziata  
BLANCO FLEXON II Low 60/4



Cod. 1526644  
Euro 284,00

Dissipatore BLANCO  
FWD Medium



Cod. 1526647  
Euro 965,00

**Accessori opzionali**

Tagliere  
in bambù



Cod. 1239449  
Euro 136,00

Gocciolatoio  
sintetico nero

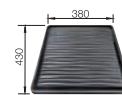

Cod. 1230734  
Euro 85,00



**BLANCO SOLIS 340/180**  
Acciaio Inox 18/10

**Incasso**

**Dettagli**  
Colore / Finitura

**Codice**

**Euro**

**75\*/80** cm base  
sottolavello



**BLANCO SOLIS 340/180-U**

Confezione in cartone - vasca DX 1526128 726,00  
Confezione in cartone - vasca SX 1526129 726,00

Dimensioni intaglio: 545x400 mm - R 42  
Profondità vasche: 185/125 mm

**Fornitura:** vasca con piletta da 3½", sifone e tappo a cestello InFino e kit di montaggio

**\*Adatto a basi sottolavello da 75 cm**

Scarico InFino  
manuale integrato  
di serie

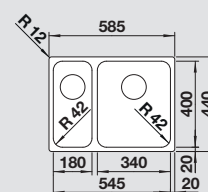

**BLANCO SOLIS 340/180-IF**

Confezione in cartone - Vasca DX 1526130 840,00  
Confezione in cartone - Vasca SX 1526131 840,00

Dimensioni intaglio per incasso sopra-top: 575x430 mm - R 15  
Profondità vasche: 185/125 mm

**Fornitura:** vasca con piletta da 3½", sifone e tappo a cestello InFino

Scarico InFino  
manuale integrato  
di serie

**60** cm base  
sottolavello

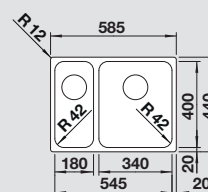

**BLANCO SOLIS 340/180-IF/A**

Confezione in cartone 1526132 1.021,00

Dimensioni intaglio per incasso sopra-top: 575x490 mm - R 15  
Profondità vasche: 185/125 mm

**Fornitura:** vasca con piletta da 3½", tappo a cestello InFino, sifone e saltarello con comando PushControl per vasca principale

**Disponibile solo con vasca a destra**

Scarico InFino e kit  
saltarello con comando  
PushControl di serie

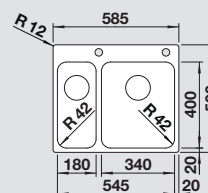

Per i modelli -IF è necessario prevedere uno scanso nello spessore del top per l'alloggiamento del troppopieno (v. pag. 260)

**Accessori opzionali**

**Kit ganci per top di spessore da 15 a 30 mm (10 pz.)**



Cod. 1223742  
Euro 15,00

**Comandi saltarello disponibili**



vedere pagina 269

**Cestello in acciaio inox**



Cod. 1514238  
Euro 130,00

**Barre multiuso in acciaio inox**



Cod. 1235906  
Euro 205,00

**Tagliere in legno multistrato**



Cod. 1230700  
Euro 352,00

**Griglia pieghevole multifunzione**



Cod. 1238482  
Euro 181,00

# BLANCO SUPRA -U, -IF, -IF/A

Il classico che diventa moderno

R60

VASCHE  
INOX



Vasca: BLANCO SUPRA 450-U  
Miscelatore: BLANCO CARENA, cromato

**BLANCO SUPRA** è la serie versatile che consente diverse **innumerevoli combinazioni**.













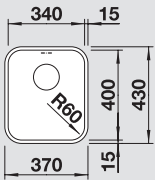

Oltre alla linea classica per incasso sottotop, tre lavelli della serie SUPRA ora sono disponibili anche con **bordo -IF**, grazie al quale l'installazione filotop o sopratop risulta particolarmente elegante. La serie BLANCO SUPRA IF/A con fascia-miscelatore integrata, offre un comfort ancora maggiore con un solo intaglio nel piano di lavoro.

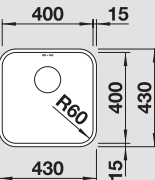

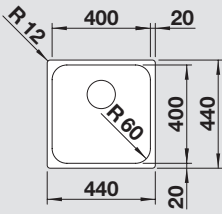
La versione con comoda fascia miscelatore è disponibile sia con comando saltarello, sia senza. Per una totale libertà di progettazione!!

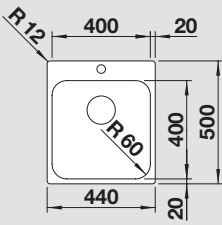

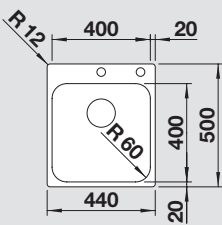
BLANCO SUPRA 340/340-U, la classica doppia vasca per incasso sottotop. Spazio e funzionalità in un'unica soluzione!

BLANCO SUPRA 340-U Acciaio Inox 18/10	Incasso	Dettagli Colore / Finitura	Codice	Euro	 <b>45</b> cm base sottolavello
	 Sottotop	Confezione in cartone	1518199	289,00	
<b>Accessori idonei:</b> 1 2 3 4 6		Dimensioni intaglio: 340x400 mm - R 60 mm Profondità vasca: 175 mm			
		<b>Fornitura:</b> vasca con piletta da 3½", tappo a cestello, sifone e kit di montaggio			
BLANCO SUPRA 400 Acciaio Inox 18/10	Incasso	Dettagli Colore / Finitura	Codice	Euro	 <b>45</b> cm base sottolavello
	 Sottotop	<b>BLANCO SUPRA 400-U</b> Confezione in cartone	1518201	301,00	
<b>Accessori idonei:</b> 1 2 3 4 6		Dimensioni intaglio: 400x400 mm - R 60 mm Profondità vasca: 175 mm			
		<b>Fornitura:</b> vasca con piletta da 3½", tappo a cestello, sifone e kit di montaggio			
	 Sopratop e filotop	<b>BLANCO SUPRA 400-IF R12</b> Confezione in cartone	1523356	386,00	
<b>Accessori idonei:</b> 1 2 3 6		Dimensioni intaglio per incasso sopratop: 430x430 mm - R 15 Profondità vasche: 175 mm			
		<b>Fornitura:</b> vasche con piletta da 3½", sifone e tappo a cestello			
	 Sopratop e filotop	<b>BLANCO SUPRA 400-IF/A R12</b> Confezione in cartone	1523358	533,00	
<b>Accessori idonei:</b> 1 2 3 6		Dimensioni intaglio per incasso sopratop: 430x490 mm - R 15 Profondità vasche: 175 mm			
		<b>Fornitura:</b> vasche con piletta da 3½", sifone e tappo a cestello			
	 Sopratop e filotop	<b>BLANCO SUPRA 400-IF/A R12 SALTARELLO INCLUSO</b> Confezione in cartone	1523357	641,00	
<b>Accessori idonei:</b> 2 3 6		Dimensioni intaglio per incasso sopratop: 430x490 mm - R 15 Profondità vasca: 175 mm			
		<b>Fornitura:</b> vasche con piletta da 3½", sifone, saltarello e tappo a cestello			
		<b>Kit saltarello con comando in materiale sintetico cromato incluso</b>			

**BLANCO SUPRA 450-U**  
Acciaio Inox 18/10



Accessori idonei:

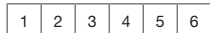

**Incasso**



Sottotop

**Dettagli**  
Colore / Finitura

Confezione in cartone

Dimensioni intaglio: 450x400 mm - R 60 mm  
Profondità vasca: 175 mm

**Fornitura:** vasca con piletta da 3½", tappo a cestello, sifone e kit di montaggio

**Codice**

1518203

**Euro**

323,00

**60** cm base  
sottolavello

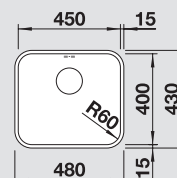

**BLANCO SUPRA 340/340-U**  
Acciaio Inox 18/10



Accessori idonei:

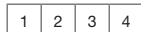

Sottotop

**Dettagli**  
Colore / Finitura

Confezione in cartone

Dimensioni intaglio: 715x400 mm - R 60 mm  
Profondità vasche: 175 mm

**Fornitura:** vasche con piletta da 3½", tappo a cestello, sifone e kit di montaggio

**Codice**

1519716

**Euro**

613,00

**90** cm base  
sottolavello

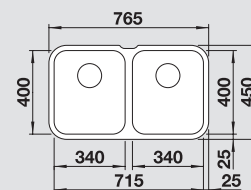

**BLANCO UNIT con BLANCO SUPRA**

Miscelatore  
BLANCO CARENA



Cod. 1520766  
Euro 505,00

Miscelatore  
BLANCO CARENA-S



Cod. 1520767  
Euro 720,00

Raccolta differenziata  
BLANCO FLEXON II Low 60/4



Cod. 1526644  
Euro 284,00

Dissipatore BLANCO  
FWD Lite



Cod. 1526646  
Euro 681,00

Gocciolatoio  
sintetico nero

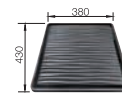

Cod. 1230734  
Euro 85,00



**BLANCO SUPRA 500**  
Acciaio Inox 18/10

**Incasto**

**Dettagli**  
Colore / Finitura

**Codice**

**Euro**

**60** cm base  
sottolavello



**Accessori idonei:**



Sottotop

**BLANCO SUPRA 500-U**

Confezione in cartone

1518205

386,00

Dimensioni intaglio: 500x400 mm - R 60 mm  
Profondità vasca: 175 mm

**Fornitura:** vasca con piletta da 3½", tappo a cestello, sifone e kit di montaggio

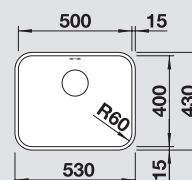

**Accessori idonei:**

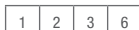

**NUOVO**  
Raggio 12 mm



Sopratop  
e filtop

**BLANCO SUPRA 500-IF R12**

Confezione in cartone

1523361

482,00

Dimensioni intaglio per incasso sopratop: 530x430 mm - R 15  
Profondità vasche: 175 mm

**Fornitura:** vasca con piletta da 3½", sifone e tappo a cestello

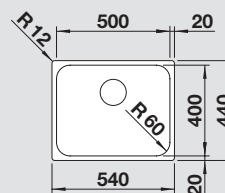

**Accessori idonei:**



**NUOVO**  
Raggio 12 mm



Sopratop  
e filtop

**BLANCO SUPRA 500-IF/A R12**

Confezione in cartone

1523363

624,00

Dimensioni intaglio per incasso sopratop: 530x490 mm - R 15  
Profondità vasca: 175 mm

**Fornitura:** vasca con piletta da 3½", sifone e tappo a cestello

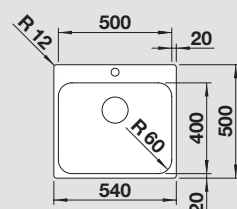

**Accessori idonei:**



**NUOVO**  
Raggio 12 mm



Sopratop  
e filtop

**BLANCO SUPRA 500-IF/A R12 SALTARELLO INCLUSO**

Confezione in cartone

1523362

731,00

Dimensioni intaglio per incasso sopratop: 530x490 mm - R 15  
Profondità vasca: 175 mm

**Fornitura:** vasca con piletta da 3½", sifone, saltarello e tappo a cestello

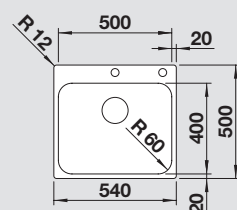

Kit saltarello  
con comando  
in materiale  
sintetico  
cromato incluso

I lavelli contrassegnati con il simbolo non possono essere montati a "inizio/fine composizione" nella base sottolavello indicata; possono essere invece facilmente inseriti in una base di misura superiore.

**Accessori opzionali**

**Kit saltarello comando + piletta**



Cod. 1901971  
Euro 102,00

1

**Barre multiuso in acciaio inox**



Cod. 1235906  
Euro 205,00

2

**Cestello inox multifunzione**



Cod. 1223297  
Euro 215,00

3

**Vassoio sintetico con ripiano forato inox**

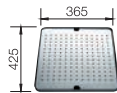

Cod. 1513485  
Euro 210,00

4

**Cestello inox con griglia per piatti**



Cod. 1507829  
Euro 239,00

5

**Griglia pieghevole multifunzione**



Cod. 1238482  
Euro 181,00

6



# MIX PERFETTO TRA NATURA E DESIGN.

## Vasche in ceramica BLANCO.

Le vasche in ceramica BLANCO creano un'atmosfera piacevole e familiare. Attraggono per le loro linee morbide e la superficie liscia.

Le vasche BLANCO in ceramica si sposano perfettamente sia nelle cucine tradizionali, sia in quelle moderne. Nei toni lucidi del Bianco Cristallo o del Magnolia, le vasche in ceramica conferiscono un aspetto caldo e accogliente nelle cucine in stile country. Per un design moderno o una rivisitazione in stile country, le vasche in ceramica nei toni del Nero e del Basalto fanno la differenza.



bianco cristallo



magnolia brillante



basalto



nero



Le proprietà della ceramica PuraPlus di BLANCO:

- Manutenzione ridotta al minimo
- Resistente agli urti e ai colpi nell'uso domestico
- Resistente a graffi e macchie
- Colori pieni, sia opachi che lucidi
- Prodotto con metodi tradizionali
- Resistente al calore
- Adatto per uso alimentare e igienico
- Resistente agli acidi alimentari
- Resistente alla luce, anche a quella solare diretta

Regolari controlli di qualità interni confermano gli elevati standard che ci siamo prefissati e garantiscono prodotti su cui fare affidamento.

# DEVOTI ALLA CERAMICA.

Le famiglie in ceramica più amate e ricercate.



## ETAGON

### Uno spazio semplicemente brillante

Grazie alle versatili barre in acciaio inox in dotazione e al loro gradino integrato, le vasche ETAGON offrono tre livelli di lavoro che possono essere sfruttati contemporaneamente. Ciò garantisce maggiore praticità ed efficienza, e allo stesso tempo fornisce risultati ottimali.



## SUBLINE

### La linea di vasche di design

La famiglia SUBLINE include le vasche in ceramica per installazione sottotop: eleganti e adatte a svariate possibilità di progettazione, in cui il piano di lavoro è protagonista.



## PANOR

### Design elegante per uno stile senza tempo

Nel classico Bianco Cristallo, la vasca PANOR si distingue grazie alle sue linee eleganti. La vasca si fa notare per la sua capienza generosa e la sua fascia miscelatore in stile country. La vasca PANOR è la scelta giusta per dare un tocco country in cucina.



## PALONA

### Il classico rivisitato in chiave moderna

PALONA, dalle forme pure, è costituito da un'ampia vasca XL con fascia miscelatore, ed è adatta anche agli spazi più ridotti. Grazie al suo design, PALONA si integra perfettamente in qualsiasi stile di cucina.



# BLANCO ETAGON 500-U

Ceramica PuraPlus

## Una vasca, due barre, tre livelli

- Ampia area di lavaggio dal minimo ingombro
- Il gradino integrato crea un livello di funzionalità aggiuntivo
- Barre ETAGON in acciaio inox in dotazione
- Scarico InFino e troppopieno rettangolare integrati

Scarico InFino  
manuale integrato  
di serie



Realizzato  
con l'esclusiva  
finitura ceramica  
PuraPlus



BLANCO ETAGON 500-U Ceramica PuraPlus	Incasso	Dettagli Colore / Finitura	Codice	Euro	60 cm base sottolavello
--	---------	-------------------------------	--------	------	----------------------------



Sottotop

Nero

1525155

1.503,00



Basalto

1525154

1.503,00



Bianco Cristallo

1525149

1.503,00



Magnolia Brillante

1525150

1.503,00

Dimensioni intaglio: 490x386 mm - R 15  
Profondità vasca: 200 mm

**Fornitura:** vasca con piletta da 3½", tappo a cestello InFino, coppia di barre in acciaio inox e sifone

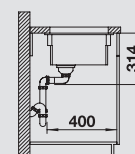
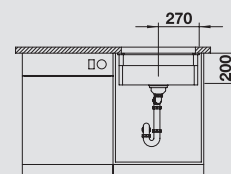
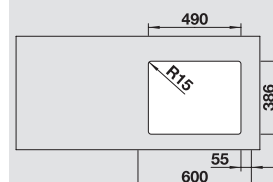
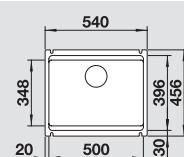

Per il passaggio da scarico InFino manuale a scarico InFino a saltarello, è necessaria la sostituzione della piletta (v. pag. 265 - Cod. 1232459)

### BLANCO UNIT con BLANCO ETAGON 500-U

### Accessori opzionali

Miscelatore  
BLANCO JANDORA-S



Cod. 1526614  
Euro 511,00

Raccolta differenziata  
BLANCO SELECT II 60/3



Cod. 1526204  
Euro 533,00

Barre ETAGON  
in acciaio inox



COMPRESSE

Vaschetta forata  
in acciaio inox



Cod. 1226189  
Euro 159,00

Tagliere  
in legno di faggio



Cod. 1514544  
Euro 181,00

Tagliere  
in cristallo temperato silver



Cod. 1227699  
Euro 205,00



# BLANCO ETAGON 6

Ceramica PuraPlus

## Una vasca, due barre, tre livelli

- Ampia area di lavaggio dal minimo ingombro
- Il gradino integrato crea un livello di funzionalità aggiuntivo
- Barre ETAGON in acciaio inox in dotazione
- Scarico InFino e troppopieno rettangolare integrati





Scarico InFino  
a saltarello  
integrato di serie



Realizzato  
con l'esclusiva  
finitura ceramica  
PuraPlus

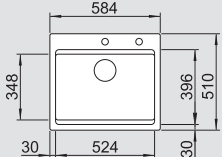
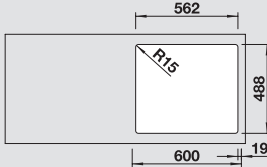
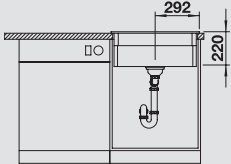
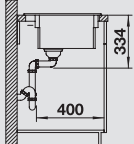

BLANCO ETAGON 6 Ceramica PuraPlus	Incasso	Dettagli Colore / Finitura	Codice	Euro	60 cm base sottolavello
	 Sopratop	<b>Nero</b>	1525162	1.514,00	   
		<b>Basalto</b>	1525161	1.514,00	
		<b>Bianco Cristallo</b>	1525156	1.514,00	
		<b>Magnolia Brillante</b>	1525157	1.514,00	
<p>Dimensioni intaglio: 562x488 mm - R 15                      Profondità vasca: 220 mm</p> <p><b>Fornitura:</b> vasca con piletta da 3½", tappo a cestello InFino, coppia di barre in acciaio inox, saltarello in materiale sintetico cromato e sifone</p>					

VASCHE  
CERAMICA

Per il passaggio da scarico InFino manuale a scarico InFino a saltarello, è necessaria la sostituzione della piletta (v. pag. 265 - Cod. 1232459)

### BLANCO UNIT con BLANCO ETAGON 6

### Accessori opzionali

Miscelatore BLANCO LINUS-S  
in acciaio massiccio spazzolato



Cod. 1517184  
Euro 692,00

Raccolta differenziata  
BLANCO SELECT II 60/3



Cod. 1526204  
Euro 533,00

Dissipatore BLANCO  
FWD Max



Cod. 1526648  
Euro 1.248,00

Barre ETAGON  
in acciaio inox



COMPRESSE

Vaschetta forata  
in acciaio inox



Cod. 1226189  
Euro 159,00

Gocciolatoio  
sintetico nero

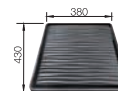

Cod. 1230734  
Euro 85,00

# BLANCO SUBLINE IN CERAMICA

Pura eleganza.

VASCHE  
CERAMICA



BLANCO SUBLINE -U in ceramica PuraPlus è la linea di vasche e lavelli sottotop per gli amanti del design. La qualità del materiale PuraPlus garantisce igiene, pulizia e la durata del nel tempo.

COLORI DISPONIBILI PER BLANCO SUBLINE CERAMICA:



Nero



Basalto

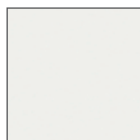

Bianco Cristallo

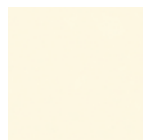

Magnolia Brillante



BLANCO SUBLINE in ceramica per incasso sottotop: raffinata soluzione di continuità col piano di lavoro.



Realizzato  
nell'esclusiva  
ceramica  
PuraPlus



**BLANCO SUBLINE 375-U**  
Ceramica PuraPlus



**Incasso**



Sottotop

**Dettagli**  
Colore / Finitura

Nero  
Basalto  
Bianco Cristallo  
Magnolia Brillante

**Codice**

1516044  
1516974  
1516042  
1519595

**Euro**

1.202,00  
1.202,00  
1.202,00  
1.202,00

**60** cm base  
sottolavello

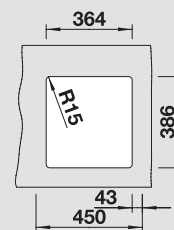
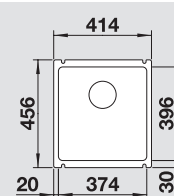

**Accessori idonei**



**Scarico InFino**  
manuale integrato  
di serie

Dimensioni intaglio: 364x386 mm - R 15  
Raggio vasca: 18 mm  
Profondità vasca: 185 mm  
Spessore minimo del piano di lavoro: 25 mm

**Fornitura:** vasca con piletta da 3/2", tappo a cestello InFino, kit di montaggio e sifone

**BLANCO SUBLINE 500-U**  
Ceramica PuraPlus



Sottotop

Nero  
Basalto  
Bianco Cristallo  
Magnolia Brillante

**Codice**

1514515  
1516975  
1514513  
1519596

**Euro**

1.383,00  
1.383,00  
1.383,00  
1.383,00

**60** cm base  
sottolavello

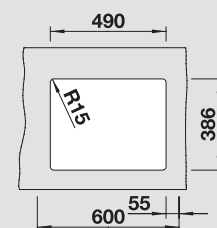
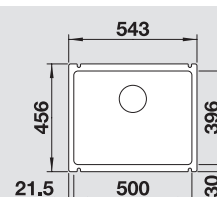

**Accessori idonei**

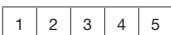

**Scarico InFino**  
manuale integrato  
di serie

Dimensioni intaglio: 490x386 mm - R 15  
Raggio vasca: 18 mm  
Profondità vasca: 185 mm  
Spessore minimo del piano di lavoro: 25 mm

**Fornitura:** vasca con piletta da 3/2", tappo a cestello InFino, kit di montaggio e sifone

**BLANCO SUBLINE 350/150-U**  
Ceramica PuraPlus



Sottotop

Nero  
Basalto  
Bianco Cristallo  
Magnolia Brillante

**Codice**

1514531  
1516976  
1514529  
1519597

**Euro**

1.542,00  
1.542,00  
1.542,00  
1.542,00

**75\*/80** cm base  
sottolavello

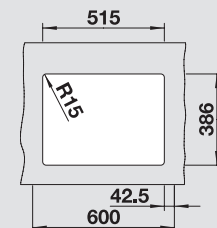
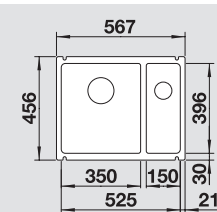

**Accessori idonei**

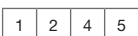

**Scarico InFino**  
manuale integrato  
di serie

Dimensioni intaglio: 515x386 mm - R 15  
Raggio vasca: 18 mm  
Profondità vasche: 185/130 mm  
Spessore minimo del piano di lavoro: 25 mm

**Fornitura:** vasca con piletta da 3/2", tappo a cestello InFino, vasca supplementare con piletta da 1/2" con tappo a cestello InFino, kit di montaggio e sifone

**\*Adatto a basi sottolavello da 75 cm**

Per il passaggio da scarico InFino manuale a scarico InFino a saltarello, è necessaria la sostituzione della piletta (v. pag. 265 - Cod. 1232459)

**BLANCO UNIT con BLANCO SUBLINE ceramica**

**Accessori opzionali**

Miscelatore BLANCO LINUS-S  
in acciaio massiccio spazzolato



Cod. 1517184  
Euro 692,00

Raccolta differenziata  
BLANCO SELECT II 60/3



Cod. 1526204  
Euro 533,00

Dissipatore BLANCO  
FWD Medium



Cod. 1526647  
Euro 965,00

Tagliere in cristallo  
satinato silver



Cod. 1227699  
Euro 205,00

Tagliere  
in legno massello



Cod. 1514544  
Euro 181,00

Cestello inox  
multifunzione



Cod. 1223297  
Euro 215,00



# BLANCO PALONA 6







Ceramica PuraPlus

## Il classico rivisitato in chiave moderna

- Design adatto alle cucine più moderne
- Bordo esterno ribassato
- Vasca ampia e profonda con utile fascia miscelatore
- Maggiore eleganza grazie allo scarico InFino e al troppopieno rettangolare

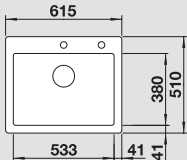
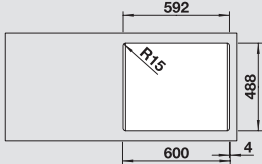
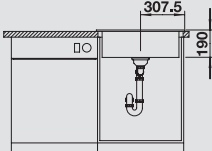
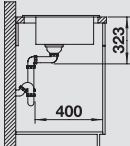
Realizzato con l'esclusiva  
finitura ceramica PuraPlus



BLANCO PALONA 6 Ceramica PuraPlus	Incasso	Dettagli Colore / Finitura	Codice	Euro	60 cm base sottolavello
	 Sopratop	Nero	1520929	1.361,00	   
		Basalto	1520928	1.361,00	
		Bianco Cristallo	1520922	1.361,00	
		Magnolia Brillante	1520923	1.361,00	
	Scarico InFino a saltarello integrato con comando PushControl® di serie				
<p>Dimensioni intaglio: 592x488 mm - R 15            Profondità vasca: 190 mm</p> <p><b>Fornitura:</b> vasca con piletta da 3½", tappo a cestello InFino, saltarello comfort cromato e sifone</p>					

VASCHE  
CERAMICA

## BLANCO UNIT con BLANCO PALONA 6

Miscelatore BLANCO LINUS-S  
in acciaio massiccio spazzolato



Cod. 1517184  
Euro 692,00

Raccolta differenziata  
BLANCO SELECT II 60/4



Cod. 1526206  
Euro 572,00

Dissipatore BLANCO  
FWD Max



Cod. 1526648  
Euro 1.248,00

Cestello inox  
con griglia per piatti



Cod. 1507829  
Euro 239,00

Kit scarico singolo  
Total Black



Cod. 1239975  
Euro 171,00

Griglia pieghevole  
multifunzione



Cod. 1238482  
Euro 181,00

## Accessori opzionali







# BLANCO PANOR 60

Ceramica

**Design elegante per uno stile senza tempo**

- Soluzione particolarmente adatta per cucine country e tradizionali
- Vasca molto ampia e capiente
- Installazione agevolata, senza bisogno di foro d'incasso

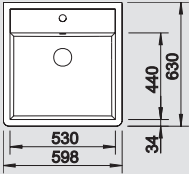
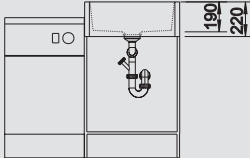
BLANCO PANOR 60 Ceramica	Incasso	Dettagli Colore / Finitura	Codice	Euro	60 cm base sottolavello
	 Sopratop	<b>1 Foro</b> Bianco Cristallo	1514486	1.202,00	
Profondità vasca: 190 mm Profondità totale lavello: 220 mm  <b>Fornitura:</b> vasca con piletta da 3½", tappo a cestello e sifone					

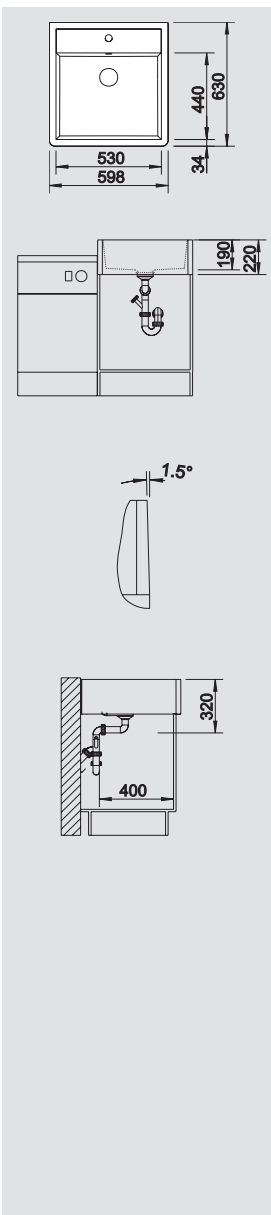

VASCHE  
CERAMICA

## BLANCO UNIT con BLANCO PANOR 60

Miscelatore BLANCO LINUS-S  
in acciaio massiccio spazzolato



Cod. 1517184  
Euro 692,00

BLANCO BOTTON Pro  
60/3 Automatica



Cod. 1517470  
Euro 312,00

Dissipatore  
BLANCO FWD Medium



Cod. 1526647  
Euro 965,00

## Accessori opzionali

Copertura scarico  
CapFlow



Cod. 1517666  
Euro 39,00

# BELLISSIMO. FORTE. PULITO.

Vasche e lavelli in SILGRANIT®



**Le vasche e i lavelli in Silgranit® sono apprezzati in tutto il mondo per lo stile, il design e l'ampia gamma di colori.** La cucina è diventata il punto focale delle nostre case e un riflesso del nostro stile di vita. Grazie all'ampia gamma di colori e al design pluripremiato, è possibile trovare il lavello o la vasca giusta in Silgranit per realizzare la cucina dei propri sogni.



Grazie alla combinazione di una superficie straordinariamente resistente e di facile manutenzione, un lavello in Silgranit è la scelta migliore per una cucina durevole nel tempo.



Il Silgranit è l'eroe nella tua cucina. La sua superficie è adatta al contatto con gli alimenti e impermeabile. Inoltre, la formula protettiva brevettata **Hygiene + Plus** riduce la proliferazione batterica mediamente del 98%. Una vasca o un lavello in Silgranit semplifica ogni giorno la vita in cucina.

**Regolari controlli di qualità interni nella produzione delle vasche e dei lavelli in Silgranit confermano gli elevati standard che BLANCO si è prefissata e assicurano prodotti sui quali fare pieno affidamento.**



# SPLENDIDI COLORI.

Scopri la bellissima gamma di colori SILGRANIT®.

La superficie vellutata di Silgranit è disponibile in una gamma di colori orientati al design e duraturi nel tempo. Il colore è una parte così importante della nostra vita, specialmente all'interno delle nostre case. È un aspetto fondamentale dell'interior design; il colore è infatti una forma di espressione creativa. Esso ha il potere di elevare, energizzare, lenire e risvegliare.

Lasciate ispirare e crea una cucina bellissima - la tua - con i colori Silgranit, disponibili per vasche, lavelli e miscelatori.

LAVELLI  
SILGRANIT



nero



antracite



grigio roccia



alumetallic



grigio vulcano



bianco



soft white



tartufo



caffè



# NON SOLO SEMPLICI LAVELLI.

Le famiglie di lavelli più desiderate in SILGRANIT®.



## METRA

### Forme squadrate e grandi capienze

Con il suo design lineare, la famiglia di lavelli METRA è perfetto con tutti i tipi di stili di cucina. Il bordo piatto rialzato si adatta perfettamente in qualsiasi ambiente. Inoltre, c'è tanto spazio in cui poter lavorare, grazie alle ampie e profonde vasche e agli spaziosi gocciolatoi.



## ELON

### Tanto spazio in un design compatto

Il lavello ELON si fa notare per il suo design compatto e la grande capacità. In questo modo è l'ideale anche per le cucine più piccole. Il gocciolatoio è contraddistinto dal suo design a onde, perfettamente abbinabile alla griglia in dotazione.



## ZIA

### Design ergonomico e massima funzionalità

I lavelli della famiglia BLANCO ZIA sono disponibili in diverse dimensioni, per soddisfare ogni esigenza. Il caratteristico bordo perimetrale permette di sfruttarne al meglio lo spazio per il miscelatore e per gli accessori opzionali. Quasi tutti i modelli sono reversibili, lasciando più scelta nella progettazione della propria cucina.





# BLANCO VINTERA XL 9-UF

## SILGRANIT

### Più spazio al rustico e al moderno.

- Vasca XL insuperabile per spazio e capienza
- Un tocco country per le cucine moderne
- Su misura per le basi da 90 cm
- Incassabile filotop o sottotop

Scarico InFino  
manuale integrato  
di serie



BLANCO VINTERA XL 9-UF Silgranit	Dettagli Colore / Finitura	Codice	Euro	90 cm base sottolavello
	Nero	1526110	1.826,00	<p>Dettagli per l'installazione, dimensioni intaglio: <a href="http://www.blanco.com/it">www.blanco.com/it</a></p>
	Antracite	1526101	1.826,00	
	Grigio Roccia	1526102	1.826,00	
	Alumetallic	1526103	1.826,00	
	Grigio Vulcano <b>NUOVO</b>	1526800	1.826,00	
	Bianco	1526105	1.826,00	
	Soft White <b>NUOVO</b>	1526803	1.826,00	
	Tartufo	1526107	1.826,00	
	Caffè	1526108	1.826,00	
	Profondità vasca: 220 mm			
	<b>Fornitura:</b> vasca con piletta da 3 1/2", sifone e tappo a cestello InFino			

LAVELLI  
SILGRANIT

**ATTENZIONE!** Le tonalità dei colori sono puramente indicative; per gli abbinamenti, usare SOLO le tabelle colori, disponibili a richiesta.

### BLANCO UNIT con BLANCO VINTERA XL 9 -UF

Miscelatore  
BLANCO LIVIA-S



Cod. 1521290  
Euro 1.491,00

Dispenser di sapone  
BLANCO LIVIA-S



Cod. 1521293  
Euro 448,00

Raccolta differenziata  
BLANCO FLEXON II Low 60/4



Cod. 1526644  
Euro 284,00

Dissipatore BLANCO  
FWD Max



Cod. 1526648  
Euro 1.248,00

### Accessori opzionali

Griglia multifunzione  
in acciaio inox



Cod. 1234795  
Euro 205,00

# BLANCO NAYA

Comfort su misura in un design elegante.



**Lavello:** BLANCO NAYA XL 9, bianco

**Miscelatore:** BLANCO LINUS-S, bianco

Mostrato nel colore:  
**Antracite**



BLANCO NAYA 45



BLANCO NAYA 5



BLANCO NAYA 6



BLANCO NAYA XL 9



BLANCO NAYA è la serie di vasche e lavelli che offre la massima flessibilità nella personalizzazione della cucina. La **versatilità** di questa linea di vasche e lavelli permette il migliore abbinamento a qualsiasi cucina. L'ampia gamma di miscelatori in finitura Silgranit ne facilita l'abbinamento. Inoltre, colpiscono per il loro design dalle **linee moderne** e bilanciate, e per il materiale che dona una sensazione vellutata al tatto. Materiale di alta qualità, Silgranit è particolarmente facile da pulire, è resistente a macchie e graffi, ed è disponibile in diversi colori.

Il modello BLANCO NAYA 8 S, con doppia vasca e gocciolatoio, è disponibile sia con vasca destra, sia con vasca sinistra.



L'ampio gocciolatoio di BLANCO NAYA 8 S aumenta lo spazio per il risciacquo e la preparazione di verdura e frutta.

LAVELLI  
SILGRANIT



**COLORI DISPONIBILI PER BLANCO NAYA:**



BLANCO NAYA 8 S



Nero

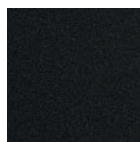

Antracite



Grigio Roccia



Alumetallic



Grigio Vulcano

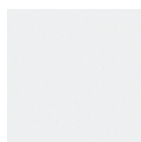

Bianco

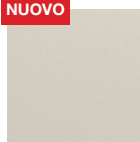

Soft White





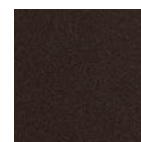

Caffè



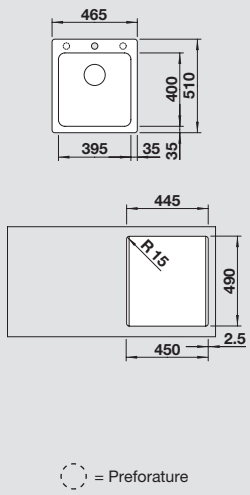

Caffè

ATTENZIONE! Le tonalità dei colori sono puramente indicative; per gli abbinamenti, usare SOLO le tabelle colori, disponibili a richiesta.

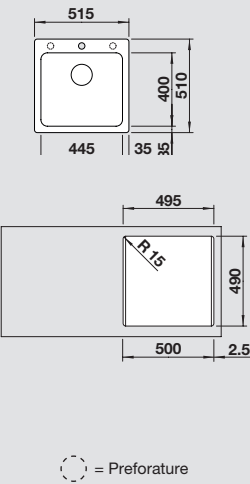
BLANCO NAYA 45 Silgranit	Incasso	Dettagli Colore / Finitura	Codice	Euro	 <b>45</b> cm base sottolavello				
 <p>Accessori idonei</p> <table border="1"> <tr><td>1</td><td>2</td><td>3</td><td>4</td></tr> </table>	1	2	3	4	 <p>Sopratop</p>	Nero	1526572	538,00	 <p>= Preforature</p>
	1	2	3	4					
	Antracite	1525222	538,00						
	Grigio Roccia	1525223	538,00						
	Alumetallic	1526573	538,00						
	Grigio Vulcano <b>NUOVO</b>	1527309	538,00						
	Bianco	1526574	538,00						
	Soft White <b>NUOVO</b>	1527126	538,00						
	Tartufo	1526576	538,00						
	Caffè	1526577	538,00						
<p>Dimensioni intaglio: 445x490 mm - R 15 Profondità vasca: 200 mm</p> <p><b>Fornitura:</b> vasca con piletta da 3½", sifone e tappo a cestello</p>									

BLANCO NAYA 5 Silgranit	Incasso	Dettagli Colore / Finitura	Codice	Euro	<b>60</b> cm base sottolavello					
 <p>Accessori idonei</p> <table border="1"> <tr><td>1</td><td>2</td><td>3</td><td>4</td><td>5</td></tr> </table>	1	2	3	4	5	 <p>Sopratop</p>	Nero	1526578	572,00	 <p>= Preforature</p>
	1	2	3	4	5					
	Antracite	1526579	572,00							
	Grigio Roccia	1526580	572,00							
	Alumetallic	1526581	572,00							
	Grigio Vulcano <b>NUOVO</b>	1527310	572,00							
	Bianco	1526582	572,00							
	Soft White <b>NUOVO</b>	1527127	572,00							
	Tartufo	1526584	572,00							
	Caffè	1526585	572,00							
<p>Dimensioni intaglio: 495x490 mm - R 15 Profondità vasca: 200 mm</p> <p><b>Fornitura:</b> vasca con piletta da 3½", sifone e tappo a cestello</p>										

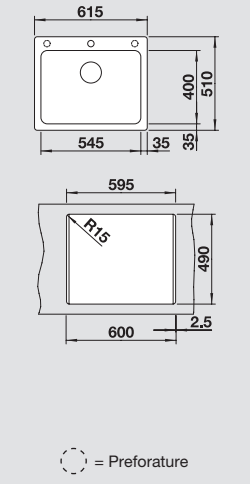
BLANCO NAYA 6 Silgranit	Incasso	Dettagli Colore / Finitura	Codice	Euro	 <b>60</b> cm base sottolavello						
 <p>Accessori idonei</p> <table border="1"> <tr><td>1</td><td>2</td><td>3</td><td>4</td><td>5</td><td>6</td></tr> </table>	1	2	3	4	5	6	 <p>Sopratop</p>	Nero	1525941	726,00	 <p>= Preforature</p>
	1	2	3	4	5	6					
	Antracite	1519638	726,00								
	Grigio Roccia	1519639	726,00								
	Alumetallic	1519640	726,00								
	Grigio Vulcano <b>NUOVO</b>	1527311	726,00								
	Bianco	1519641	726,00								
	Soft White <b>NUOVO</b>	1527128	726,00								
	Tartufo	1519644	726,00								
	Caffè	1519645	726,00								
<p>Dimensioni intaglio: 595x490 mm - R 15 Profondità vasca: 200 mm</p> <p><b>Fornitura:</b> vasca con piletta da 3½", sifone e tappo a cestello</p>											

BLANCO UNIT con BLANCO NAYA					Accessori opzionali	
<p>Miscelatore BLANCO MIDA</p>  <p>Cod. 1519415 Euro 223,00</p>	<p>Dispenser di sapone BLANCO LATO</p>  <p>Cod. 1525810 Euro 159,00</p>	<p>Raccolta differenziata BLANCO FLEXON II Low 60/4</p>  <p>Cod. 1526644 Euro 284,00</p>	<p>Dissipatore BLANCO FWD Medium <b>NUOVO</b></p>  <p>Cod. 1526647 Euro 965,00</p>	<p>Tagliere in legno massello di faggio</p>  <p>Cod. 1225362 Euro 171,00</p>	<p>Griglia multifunzione in acciaio inox</p>  <p>Cod. 1234795 Euro 205,00</p>	



**BLANCO NAYA XL 9**  
Silgranit



Accessori idonei



Incasso



Sopratop

Dettagli  
Colore / Finitura

Nero	1525947	772,00
Antracite	1521811	772,00
Grigio Roccia	1521813	772,00
Alumetallic	1521814	772,00
Grigio Vulcano <b>NUOVO</b>	1527316	772,00
Bianco	1521816	772,00
Soft White <b>NUOVO</b>	1527133	772,00
Tartufo	1521819	772,00
Caffè	1521820	772,00

Codice

Euro

Dimensioni intaglio: 840x490 mm - R 15  
Profondità vasca: 220 mm

**Fornitura:** vasca con piletta da 3½", tappo a cestello e sifone

**90** cm base  
sottolavello

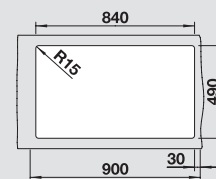
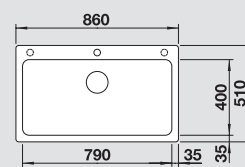

○ = Prefature

**BLANCO NAYA 8 S**  
Silgranit



Accessori idonei



Sopratop

Dettagli  
Colore / Finitura

Nero	1525945	1525946	902,00
Antracite	1519654	1525779	902,00
Grigio Roccia	1519655	1525780	902,00
Alumetallic	1519656	1525781	902,00
Grigio Vulcano <b>NUOVO</b>	1527314	1527315	902,00
Bianco	1519657	1525783	902,00
Soft White <b>NUOVO</b>	1527131	1527132	902,00
Tartufo	1519660	1525785	902,00
Caffè	1519661	1525786	902,00

**NUOVO**

Dimensioni intaglio: 1140x480 mm - R 15  
Profondità vasca: 200/200 mm

**Fornitura:** vasche con piletta da 3½", tappo a cestello e sifone

**80** cm base  
sottolavello

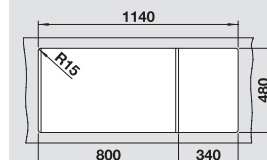
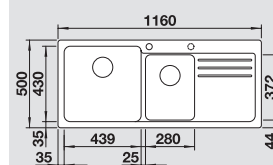

○ = Prefature

LAVELLI  
SILGRANIT



BLANCO NAYA 8 S con vasca destra, tartufo

I lavelli contrassegnati con il simbolo non possono essere montati a "inizio/fine composizione" nella base sottolavello indicata; possono essere invece facilmente inseriti in una base di misura superiore.

**N.B.:** Per il montaggio su **piani di marmo**, ordinare l'apposito kit (v. pag. 262)

**ATTENZIONE!** Le tonalità dei colori sono puramente indicative; per gli abbinamenti, usare SOLO le tabelle colori, disponibili a richiesta.

**Accessori opzionali**

Gocciolatoio  
sintetico nero

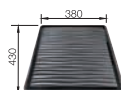

Cod. 1230734  
Euro 85,00

3

Tagliere a ponte  
in materiale sintetico



Cod. 1210521  
Euro 181,00

4

Cestello inox  
con griglia per piatti

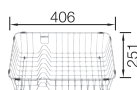

Cod. 1231692  
Euro 125,00

5

Barre  
in acciaio inox



Cod. 1235906  
Euro 205,00

6

Tagliere a ponte  
in legno massello

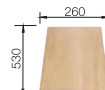

Cod. 1218313  
Euro 136,00

7

Cestello inox  
con griglia per piatti



Cod. 1231693  
Euro 125,00

8

# BLANCO PLEON

Vasche XL per la massima capienza.



LAVELLI  
SILGRANIT

Mostrato nel colore:  
**Soft White**



BLANCO PLEON 5



BLANCO PLEON 6



BLANCO PLEON 6 Split



BLANCO PLEON 8



BLANCO PLEON 9



Linee pulite e **spazio** in abbondanza sono le caratteristiche principali della gamma BLANCO PLEON.

Il divisorio ribassato, presente nel modello PLEON 6 S Split crea una seconda vasca nello stesso spazio. Inoltre, tutte le vasche si rinnovano grazie allo **scarico InFino integrato**, elegante, di facile pulizia e manutenzione.

L'ampiezza e la **profondità delle vasche** (220 mm) rendono i modelli PLEON ancora più pratici e funzionali.



Ancora più comfort e igiene nell'area del lavello.

\*Spessore totale del bordo: 0,5 cm



COLORI DISPONIBILI PER BLANCO PLEON:



Nero

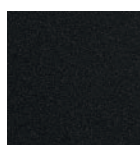

Antracite



Grigio Roccia



Alumetallic



Grigio Vulcano

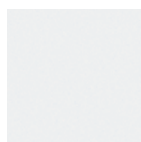

Bianco

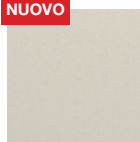

Soft White



Tartufo



Caffè

ATTENZIONE! Le tonalità dei colori sono puramente indicative; per gli abbinamenti, usare SOLO le tabelle colori, disponibili a richiesta.

LAVELLI  
SIL GRANIT

**BLANCO PLEON 5  
Silgranit**

**Accessori idonei**

Scarico InFino manuale integrato di serie

**Incasso**



Sopratop

**Dettagli  
Colore / Finitura**

Nero	1525951	879,00
Antracite	1521504	879,00
Grigio Roccia	1521669	879,00
Alumetallic	1521670	879,00
Grigio Vulcano <b>NUOVO</b>	1527318	879,00
Bianco	1521672	879,00
Soft White <b>NUOVO</b>	1527135	879,00
Tartufo	1521675	879,00
Caffè	1521677	879,00

 Dimensioni intaglio: 495x490 mm - R 15  
 Profondità vasca: 220 mm

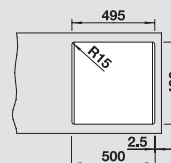
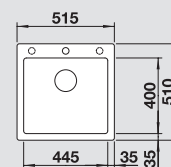
**Fornitura:** vasca con piletta da 3½", sifone e tappo a cestello InFino

**Codice Euro**
**50** cm base sottolavello

= Preforature

**BLANCO PLEON 6  
Silgranit**

**Accessori idonei**

Scarico InFino manuale integrato di serie

**Incasso**



Sopratop

**Dettagli  
Colore / Finitura**

Nero	1525953	913,00
Antracite	1521678	913,00
Grigio Roccia	1521679	913,00
Alumetallic	1521681	913,00
Grigio Vulcano <b>NUOVO</b>	1527320	913,00
Bianco	1521683	913,00
Soft White <b>NUOVO</b>	1527137	913,00
Tartufo	1521686	913,00
Caffè	1521688	913,00

 Dimensioni intaglio: 595x490 mm - R 15  
 Profondità vasca: 220 mm

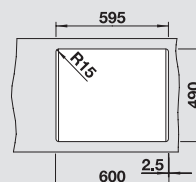
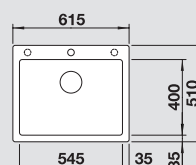
**Fornitura:** vasca con piletta da 3½", sifone e tappo a cestello InFino

**Codice Euro**
**60** cm base sottolavello

= Preforature

**BLANCO PLEON 6 Split  
Silgranit**

**Accessori idonei**

Scarico InFino manuale integrato di serie

**Incasso**



Sopratop

**Dettagli  
Colore / Finitura**

Nero	1525955	1.038,00
Antracite	1521689	1.038,00
Grigio Roccia	1521690	1.038,00
Alumetallic	1521691	1.038,00
Grigio Vulcano <b>NUOVO</b>	1527322	1.038,00
Bianco	1521693	1.038,00
Soft White <b>NUOVO</b>	1527139	1.038,00
Tartufo	1521696	1.038,00
Caffè	1521698	1.038,00

 Dimensioni intaglio: 595x490 mm - R 15  
 Profondità vasca: 220/200 mm

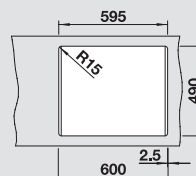
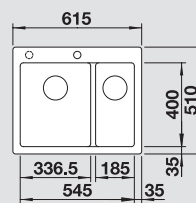
**Fornitura:** vasca con piletta da 3½", sifone e tappo a cestello InFino

**Codice Euro**
**60** cm base sottolavello

= Preforature

**BLANCO UNIT con BLANCO PLEON**
**Accessori opzionali**
**Miscelatore  
BLANCO LINUS-S**

 Cod. 1526959  
 Euro 488,00

**Raccolta differenziata  
BLANCO SELECT II 60/3**

 Cod. 1526204  
 Euro 533,00

**Tagliere  
in legno multistrato**

 Cod. 1230700  
 Euro 352,00

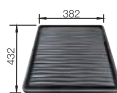
**Gocciolatoio  
sintetico nero**

 Cod. 1230734  
 Euro 85,00





**Barre  
in acciaio inox**

 Cod. 1235906  
 Euro 205,00

**Griglia pieghevole  
multifunzione**

 Cod. 1238482  
 Euro 181,00

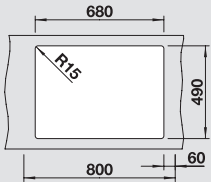

BLANCO PLEON 8 Silgranit	Incasso	Dettagli Colore / Finitura	Codice	Euro	 <b>80</b> cm base sottolavello
	 Sopratop	Nero	1525957	953,00	  = Preforature
		Antracite	1518336	953,00	
Grigio Roccia	1518908	953,00			
Alumetallic	1518337	953,00			
Grigio Vulcano <b>NUOVO</b>	1527323	953,00			
Bianco	1518339	953,00			
Soft White <b>NUOVO</b>	1527140	953,00			
Tartufo	1518343	953,00			
Caffè	1518344	953,00			
 Scarico InFino manuale integrato di serie		Dimensioni intaglio: 680x490 mm - R 15 Profondità vasche: 220 mm <b>Fornitura:</b> vasca con piletta da 3½", sifone e tappo a cestello InFino			

BLANCO PLEON 9 Silgranit	Incasso	Dettagli Colore / Finitura	Codice	Euro	<b>90</b> cm base sottolavello
	 Sopratop	Nero	1525958	1.100,00	  = Preforature
		Antracite	1518345	1.100,00	
Grigio Roccia	1518909	1.100,00			
Alumetallic	1518346	1.100,00			
Grigio Vulcano <b>NUOVO</b>	1527325	1.100,00			
Bianco	1518348	1.100,00			
Soft White <b>NUOVO</b>	1527142	1.100,00			
Tartufo	1518352	1.100,00			
Caffè	1518353	1.100,00			
 Scarico InFino manuale integrato di serie		Dimensioni intaglio: 840x480 mm - R 15 Profondità vasche: 220 mm <b>Fornitura:</b> vasca con piletta da 3½", sifone e tappo a cestello InFino			



I lavelli contrassegnati con il simbolo  non possono essere montati a "inizio/fine composizione" nella base sottolavello indicata; possono essere invece facilmente inseriti in una base di misura superiore.

**N.B.:** Per il montaggio su **piani di marmo**, ordinare l'apposito kit (v. pag. 262)

**ATTENZIONE!** Le tonalità dei colori sono puramente indicative; per gli abbinamenti, usare SOLO le tabelle colori, disponibili a richiesta.

#### Accessori opzionali

**Vaschetta angolare multifunzione**



Cod. 1235866  
Euro 96,00

5

**Griglia multifunzione in acciaio inox**



Cod. 1234795  
Euro 205,00

6

**Tagliere a ponte in legno massello**



Cod. 1218313  
Euro 136,00

7

**Vaschetta forata in acciaio inox**



Cod. 1227689  
Euro 147,00

8

**Tagliere a ponte in materiale sintetico**



Cod. 1210521  
Euro 181,00

9

**Cestello inox multifunzione**



Cod. 1223297  
Euro 215,00

10

# BLANCO ELON

Molteplici personalizzazioni di utilizzo in un piccolo spazio.



LAVELLI  
SILGRANIT

BLANCO ELON è una linea di lavelli capienti di misura compatta: ampia vasca e **griglia multifunzione** perfettamente abbinata al gocciolatoio. Tutto in uno spazio ridotto e confortevole. La griglia, inclusa nella fornitura, può essere utilizzata anche come sottopentola decorativo.



BLANCO ELON: scarico Infino a saltarello di serie per tutti i modelli.





## COLORI DISPONIBILI PER BLANCO ELON:







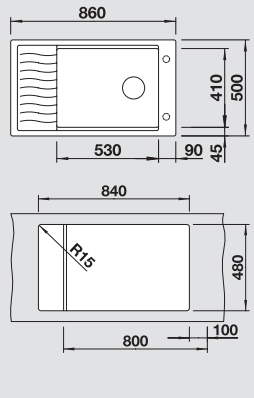

ATTENZIONE! Le tonalità dei colori sono puramente indicative; per gli abbinamenti, usare SOLO le tabelle colori, disponibili a richiesta.

BLANCO ELON 45 S Silgranit	Incasso	Dettagli Colore / Finitura	Codice	Euro	45 cm base sottolavello
	 Sopratop	Nero	1525879	782,00	 <p>= Prefature</p>
		Antracite	1520989	782,00	
Grigio Roccia	1520990	782,00			
Alumetallic	1520991	782,00			
Grigio Vulcano <b>NUOVO</b>	1527251	782,00			
Bianco	1520993	782,00			
Soft White <b>NUOVO</b>	1527068	782,00			
Tartufo	1520996	782,00			
Caffè	1520997	782,00			
Dimensioni intaglio: 630x480 mm - R 15 Profondità vasca: 205 mm					
<b>Fornitura:</b> vasca con piletta da 3½", tappo a cestello, saltarello, griglia multifunzione in acciaio inox e sifone					
<b>Modello reversibile</b>					
					
					

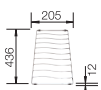
BLANCO ELON XL 6 S Silgranit	Incasso	Dettagli Colore / Finitura	Codice	Euro	60 cm base sottolavello
	 Sopratop	Nero	1525882	828,00	 <p>= Prefature</p>
		Antracite	1518735	828,00	
Grigio Roccia	1518736	828,00			
Alumetallic	1518737	828,00			
Grigio Vulcano <b>NUOVO</b>	1527253	828,00			
Bianco	1518739	828,00			
Soft White <b>NUOVO</b>	1527070	828,00			
Tartufo	1518743	828,00			
Caffè	1518744	828,00			
Dimensioni intaglio: 760x480 mm - R 15 Profondità vasca: 205 mm					
<b>Fornitura:</b> vasca con piletta da 3½", tappo a cestello, saltarello, griglia multifunzione in acciaio inox e sifone					
<b>Modello reversibile</b>					
					
					

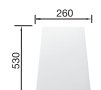
BLANCO ELON XL 8 S Silgranit	Incasso	Dettagli Colore / Finitura	Codice	Euro	80 cm base sottolavello
	 Sopratop	Nero	1525885	965,00	 <p>= Prefature</p>
		Antracite	1520484	965,00	
Grigio Roccia	1520485	965,00			
Alumetallic	1520486	965,00			
Grigio Vulcano <b>NUOVO</b>	1527256	965,00			
Bianco	1520488	965,00			
Soft White <b>NUOVO</b>	1527073	965,00			
Tartufo	1520491	965,00			
Caffè	1520492	965,00			
Dimensioni intaglio: 840x480 mm - R 15 Profondità vasche: 205 mm					
<b>Fornitura:</b> vasche con piletta da 3½", tappo a cestello, saltarello, griglia multifunzione in acciaio inox e sifone					
<b>Modello reversibile</b>					
					
					

**N.B.:** Per il montaggio su piani di marmo, ordinare l'apposito kit (v. pag. 262-.,mnbvc)

Accessori opzionali					
<b>Griglia multifunzione in acciaio inox</b> 	<b>Tagliere a ponte in legno massello</b> 	<b>Tagliere a ponte in materiale sintetico</b> 	<b>Vaschetta forata in acciaio inox</b> 	<b>Cestello inox multifunzione</b> 	<b>Cestello inox con griglia per piatti</b> 
COMPRESA	Cod. 1218313 Euro 136,00	Cod. 1217611 Euro 142,00	Cod. 1227689 Euro 147,00	Cod. 1223297 Euro 215,00	Cod. 1507829 Euro 239,00



# BLANCO METRA

Forme squadrate e grandi capienze.



LAVELLI  
SILGRANIT

La serie di lavelli BLANCO METRA è una linea dal **design pulito**, caratterizzato dalle **ampie vasche** che permettono il lavaggio anche delle stoviglie più voluminose. Il materiale di cui sono composti, il SILGRANIT®, ha una **superficie** molto simile alla pietra naturale, in grado di ritardare la formazione del calcare, con uno straordinario “effetto seta” al tatto, estremamente solido e semplice da pulire.



BLANCO METRA: design lineare, vasche ampie e profonde, numerosi e pratici accessori. La massima espressione del comfort.

## COLORI DISPONIBILI PER BLANCO METRA:



ATTENZIONE! Le tonalità dei colori sono puramente indicative; per gli abbinamenti, usare SOLO le tabelle colori, disponibili a richiesta.



**BLANCO METRA 45 S  
Silgranit**

**Accessori idonei**

**Incasso**



Sopratop

**Dettagli  
Colore / Finitura**

Dettaglio	Codice	Euro
Nero	1525915	686,00
Antracite	1513194	686,00
Grigio Roccia	1518869	686,00
Alumetallic	1513186	686,00
Grigio Vulcano <b>NUOVO</b>	1527289	686,00
Bianco	1513187	686,00
Soft White <b>NUOVO</b>	1527106	686,00
Tartufo	1517346	686,00
Caffè	1515039	686,00

 Dimensioni intaglio: 760x480 mm - R 15  
 Profondità vasca: 205 mm

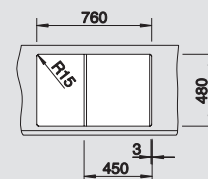
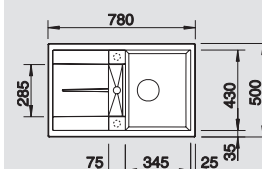
**Fornitura:** vasca con piletta da 3½", sifone, tappo a cestello e gocciolatoio sifonato

 **45** cm base sottolavello

= Preferature

**BLANCO METRA 5 S  
Silgranit**

**Accessori idonei**

**Incasso**



Sopratop

**Dettagli  
Colore / Finitura**

Dettaglio	Codice	Euro
Nero	1525919	697,00
Antracite	1513212	697,00
Grigio Roccia	1518872	697,00
Alumetallic	1513204	697,00
Grigio Vulcano <b>NUOVO</b>	1527293	697,00
Bianco	1513205	697,00
Soft White <b>NUOVO</b>	1527110	697,00
Tartufo	1517349	697,00
Caffè	1515042	697,00

 Dimensioni intaglio: 840x480 mm - R 15  
 Profondità vasca: 205 mm

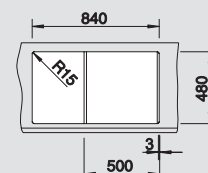
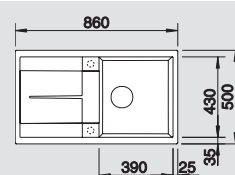
**Fornitura:** vasca con piletta da 3½", sifone e tappo a cestello

**Modello reversibile**
**50** cm base sottolavello

= Preferature

**BLANCO METRA XL 6 S  
Silgranit**

**Accessori idonei**

**Incasso**



Sopratop

**Dettagli  
Colore / Finitura**

Dettaglio	Codice	Euro
Nero	1525930	709,00
Antracite	1515142	709,00
Grigio Roccia	1518880	709,00
Alumetallic	1515135	709,00
Grigio Vulcano <b>NUOVO</b>	1527307	709,00
Bianco	1515136	709,00
Soft White <b>NUOVO</b>	1527124	709,00
Tartufo	1517359	709,00
Caffè	1515143	709,00

 Dimensioni intaglio: 980x480 mm - R 15  
 Profondità vasca: 205 mm

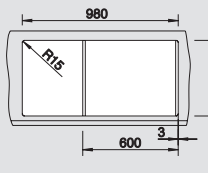
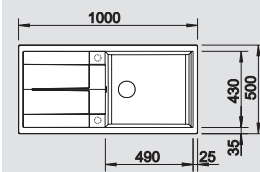
**Fornitura:** vasca con piletta da 3½", sifone e tappo a cestello

**Modello reversibile**
**60** cm base sottolavello

= Preferature

I lavelli contrassegnati con il simbolo non possono essere montati a "inizio/fine composizione" nella base sottolavello indicata; possono essere invece facilmente inseriti in una base di misura superiore.

**N.B.:** Per il montaggio su **piani di marmo**, ordinare l'apposito kit (v. pag. 258)

**Accessori opzionali**
**Vaschetta angolare  
multifunzione**

 Cod. 1235866  
 Euro 96,00

1

**Cestello inox  
multifunzione**

 Cod. 1223297  
 Euro 215,00

2

**Tagliere a ponte  
in materiale sintetico**

 Cod. 1217611  
 Euro 142,00

3

**Tagliere a ponte  
in legno massello**

 Cod. 1218313  
 Euro 136,00

4

**Vaschetta forata  
in acciaio inox**

 Cod. 1217796  
 Euro 153,00

5

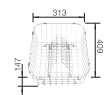
**Cestello inox  
con griglia per piatti**

 Cod. 1507829  
 Euro 238,00

6

**BLANCO METRA 6  
Silgranit**

Accessori idonei



**Incasso**
**Dettagli  
Colore / Finitura**
**Codice**
**Euro**

Sopratop

Nero	1525923	714,00
Antracite	1516179	714,00
Grigio Roccia	1518875	714,00
Alumetallic	1516172	714,00
Grigio Vulcano <b>NUOVO</b>	1527296	714,00
Bianco	1516173	714,00
Soft White <b>NUOVO</b>	1527113	714,00
Tartufo	1517352	714,00
Caffè	1516180	714,00

 Dimensioni intaglio: 595x480 mm - R 15  
 Profondità vasche: 145/205 mm

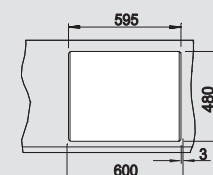
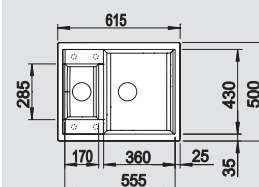
**Fornitura:** vasca con piletta da 3½", sifone e tappo a cestello

**Modello reversibile**
**60** cm base  
sottolavello

= Preforature

**BLANCO METRA 6 S Compact  
Silgranit**

Accessori idonei



 KIT COMANDO  
SALTARELLO  
INCLUSO

Sopratop

Nero	1525925	731,00
Antracite	1513473	731,00
Grigio Roccia	1518876	731,00
Alumetallic	1513553	731,00
Grigio Vulcano <b>NUOVO</b>	1527297	731,00
Bianco	1513468	731,00
Soft White <b>NUOVO</b>	1527114	731,00
Tartufo	1517353	731,00
Caffè	1515044	731,00

 Dimensioni intaglio: 760x480 mm - R 15  
 Profondità vasche: 205/145 mm

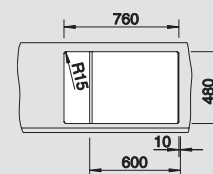
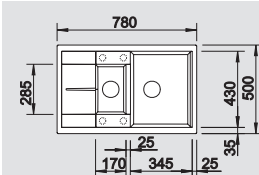
**Fornitura:** vasche con piletta da 3½", sifone, tappo a cestello e saltarello (solo per la vasca principale)

**Modello reversibile**
**60** cm base  
sottolavello

= Preforature

**BLANCO METRA 6 S  
Silgranit**

Accessori idonei



Sopratop

Nero	1525927	748,00
Antracite	1513230	748,00
Grigio Roccia	1518878	748,00
Alumetallic	1513222	748,00
Grigio Vulcano <b>NUOVO</b>	1527300	748,00
Bianco	1513223	748,00
Soft White <b>NUOVO</b>	1527117	748,00
Tartufo	1517355	748,00
Caffè	1515046	748,00

 Dimensioni intaglio: 980x480 mm - R 15  
 Profondità vasche: 205/145 mm

**Fornitura:** vasche con piletta da 3½", sifone e tappo a cestello

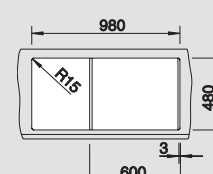
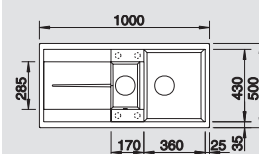
**Modello reversibile**
**60** cm base  
sottolavello

= Preforature

**BLANCO UNIT con BLANCO METRA**
**Miscelatore  
BLANCO ALTA Compact**



 Cod. 1515323  
 Euro 748,00

**Raccolta differenziata  
BLANCO SELECT II 60/3**



 Cod. 1526204  
 Euro 533,00

**Dissipatore BLANCO  
FWD Medium**

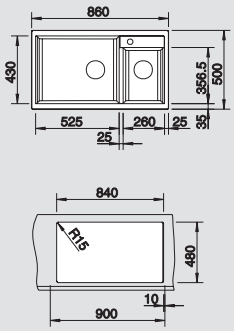

 Cod. 1526647  
 Euro 965,00

BLANCO METRA 9 Silgranit	Incasso	Dettagli Colore / Finitura	Codice	Euro	 <b>90</b> cm base sottolavello
	 Sopratop	Nero	1525936	743,00	 <p>= Prefature</p>
		Antracite	1513273	743,00	
		Grigio Roccia	1518886	743,00	
		Alumetallic	1513268	743,00	
		Grigio Vulcano <b>NUOVO</b>	1527304	743,00	
		Bianco	1513269	743,00	
		Soft White <b>NUOVO</b>	1527121	743,00	
		Tartufo	1517364	743,00	
		Caffè	1515050	743,00	
		Dimensioni intaglio: 840x480 mm - R 15 Profondità vasche: 205 mm  <b>Fornitura:</b> vasche con piletta da 3½", sifone e tappo a cestello			

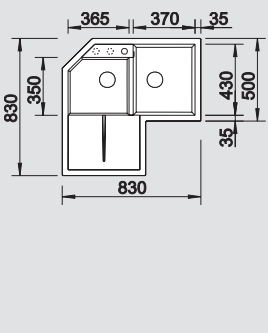
BLANCO METRA 8 S Silgranit	Incasso	Dettagli Colore / Finitura	Codice	Euro	 <b>80</b> cm base sottolavello
	 Sopratop	Nero	1525934	760,00	 <p>= Prefature</p>
		Antracite	1513071	760,00	
		Grigio Roccia	1518884	760,00	
		Alumetallic	1513063	760,00	
		Grigio Vulcano <b>NUOVO</b>	1527303	760,00	
		Bianco	1513064	760,00	
		Soft White <b>NUOVO</b>	1527120	760,00	
		Tartufo	1517357	760,00	
		Caffè	1515048	760,00	
		Dimensioni intaglio: 1140x480 mm - R 15 Profondità vasche: 205 mm  <b>Fornitura:</b> vasche con piletta da 3½", sifone e tappo a cestello  <b>Modello reversibile</b>			

BLANCO METRA 9 E Silgranit	Incasso	Dettagli Colore / Finitura	Codice	Euro	Base sottolavello angolare
	 Sopratop	Nero	1525938	902,00	 <p>= Prefature</p>
		Antracite	1515576	902,00	
		Grigio Roccia	1518888	902,00	
		Alumetallic	1515567	902,00	
		Grigio Vulcano <b>NUOVO</b>	1526798	902,00	
		Bianco	1515568	902,00	
		Soft White <b>NUOVO</b>	1526801	902,00	
		Tartufo	1517367	902,00	
		Caffè	1515573	902,00	
		Dimensioni intaglio: dima in dotazione Profondità vasche: 145/205 mm <b>Disponibile solo con gocciolatoio a sinistra</b>  <b>Fornitura:</b> 2 vasche con piletta da 3½", sifone e tappo a cestello			

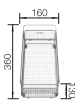
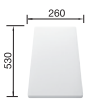
I lavelli contrassegnati con il simbolo  non possono essere montati a "inizio/fine composizione" nella base sottolavello indicata; possono essere invece facilmente inseriti in una base di misura superiore.  
**N.B.:** Per il montaggio su **piani di marmo**, ordinare l'apposito kit (v. pag. 258)

Accessori opzionali					
<b>Vaschetta angolare multifunzione</b> 	<b>Cestello inox multifunzione</b> 	<b>Tagliere a ponte in materiale sintetico</b> 	<b>Tagliere a ponte in legno massello</b> 	<b>Vaschetta forata in acciaio inox</b> 	<b>Cestello inox con griglia per piatti</b> 
Cod. Euro 1235866 96,00	Cod. Euro 1223297 215,00	Cod. Euro 1217611 142,00	Cod. Euro 1218313 136,00	Cod. Euro 1217796 153,00	Cod. Euro 1507829 239,00
1	2	3	4	5	6

LAVELLI  
SILGRANIT

# BLANCO DALAGO, -F

Linee essenziali, massima comodità.



LAVELLI  
SILGRANIT

Mostrato nel colore:  
**Caffè**



BLANCO DALAGO 45  
BLANCO DALAGO 45-F



BLANCO DALAGO 5  
BLANCO DALAGO 5-F



BLANCO DALAGO 6  
BLANCO DALAGO 6-F





I lavelli BLANCO DALAGO si distinguono per le loro vasche ampie e capienti. BLANCO DALAGO è una famiglia di lavelli che si caratterizza per il suo **design attuale**, dalle linee moderne; tutti i modelli sono dotati di un'ampia **fascia multifunzione**, sulla quale poter installare il dispenser di sapone, l'interruttore pneumatico del dissipatore di rifiuti, o altri elementi funzionali.



Lo scarico a saltarello, integrato di serie in tutti i modelli, aumenta il livello di comfort e funzionalità.



I modelli della famiglia BLANCO DALAGO sono disponibili anche per l'installazione a filotop (-F).



La funzionalità dei modelli BLANCO DALAGO è ulteriormente incrementata con i pratici accessori opzionali, come la vaschetta ad angolo.



Tipologia di incasso:

**COLORI DISPONIBILI PER BLANCO DALAGO:**



BLANCO DALAGO 8  
BLANCO DALAGO 8-F



Nero

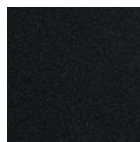

Antracite



Grigio Roccia



Alumetallic



Grigio Vulcano

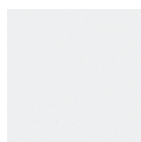

Bianco



Soft White



Tartufo



Caffè

ATTENZIONE! Le tonalità dei colori sono puramente indicative; per gli abbinamenti, usare SOLO le tabelle colori, disponibili a richiesta.

LAVELLI  
SIL GRANIT

**BLANCO DALAGO 45  
Silgranit**

**Accessori idonei**

1 2

**KIT COMANDO  
SALTARELLO  
INCLUSO**
**Incasso**

**Sopratop**
**Dettagli  
Colore / Finitura**
**BLANCO DALAGO 45**

Nero	1525869	596,00
Antracite	1517156	596,00
Grigio Roccia	1518846	596,00
Alumetallic	1517157	596,00
Grigio Vulcano	1527242	596,00
Bianco	1517160	596,00
Soft White	1527059	596,00
Tartufo	1517317	596,00
Caffè	1517165	596,00

 Dimensioni intaglio: 445x490 mm - R 15  
 Profondità vasca: 205 mm

**Fornitura:** vasca con piletta da 3½", tappo a cestello, saltarello e sifone

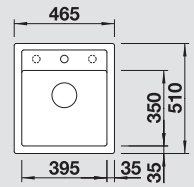
**Codice**
**Euro**
**45** cm base  
sottolavello

**Accessori idonei**

2

**KIT COMANDO  
SALTARELLO  
INCLUSO**

**Incasso  
filotop**
**BLANCO DALAGO 45-F**

Nero	1525870	782,00
Antracite	1517166	782,00
Grigio Roccia	1518847	782,00
Alumetallic	1517167	782,00
Grigio Vulcano	1527243	782,00
Bianco	1517169	782,00
Soft White	1527060	782,00
Caffè	1517171	782,00

Profondità vasca: 190 mm

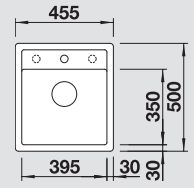
**Fornitura:** vasca con piletta da 3½", tappo a cestello, saltarello e sifone

= Preferature

**BLANCO DALAGO 5  
Silgranit**

**Accessori idonei**

1 2 3 4

**KIT COMANDO  
SALTARELLO  
INCLUSO**

**Sopratop**
**BLANCO DALAGO 5**

Nero	1525871	635,00
Antracite	1518521	635,00
Grigio Roccia	1518848	635,00
Alumetallic	1518522	635,00
Grigio Vulcano	1527244	635,00
Bianco	1518524	635,00
Soft White	1527061	635,00
Tartufo	1518528	635,00
Caffè	1518529	635,00

 Dimensioni intaglio: 495x490 mm - R 15  
 Profondità vasca: 205 mm

**Fornitura:** vasca con piletta da 3½", tappo a cestello, saltarello e sifone

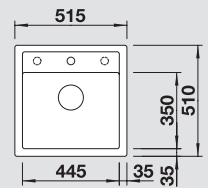
 **50** cm base  
sottolavello

**Accessori idonei**

2 3 4

**KIT COMANDO  
SALTARELLO  
INCLUSO**

**Incasso  
filotop**
**BLANCO DALAGO 5-F**

Nero	1525872	828,00
Antracite	1518530	828,00
Grigio Roccia	1518849	828,00
Alumetallic	1518531	828,00
Grigio Vulcano	1527245	828,00
Bianco	1518532	828,00
Soft White	1527062	828,00
Caffè	1518536	828,00

Profondità vasca: 190 mm

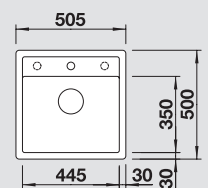
**Fornitura:** vasca con piletta da 3½", tappo a cestello, saltarello e sifone

= Preferature

**BLANCO UNIT con BLANCO DALAGO e DALAGO -F**
**Miscelatore  
BLANCO ALTA-S Compact**



 Cod. 1515334  
 Euro 999,00



**Raccolta differenziata  
BLANCO FLEXON II Low 60/3**

 Cod. 1526642  
 Euro 239,00

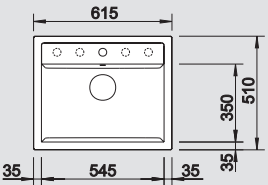

**Dissipatore BLANCO  
FWD Medium**

 Cod. 1526647  
 Euro 965,00

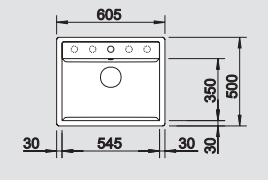
BLANCO DALAGO 6 Silgranit	Incasso	Dettagli Colore / Finitura	Codice	Euro	 <b>60</b> cm base sottolavello
	 Sopratop	<b>BLANCO DALAGO 6</b>			
		Nero	1525873	669,00	
Antracite	1514197	669,00			
Grigio Roccia	1518850	669,00			
Alumetallic	1514198	669,00			
Grigio Vulcano <b>NUOVO</b>	1527246	669,00			
Bianco	1514199	669,00			
Soft White <b>NUOVO</b>	1527063	669,00			
Tartufo	1517320	669,00			
Caffè	1515066	669,00			
Dimensioni intaglio: 595x490 mm - R 15 Profondità vasca: 205 mm					
<b>Fornitura:</b> vasca con pileta da 3½", tappo a cestello, saltarello e sifone					

BLANCO DALAGO 6-F Silgranit	Incasso	Dettagli Colore / Finitura	Codice	Euro	 <b>80</b> cm base sottolavello
	 Incasso filotop	<b>BLANCO DALAGO 6-F</b>			
		Nero	1525875	873,00	
Antracite	1514773	873,00			
Grigio Roccia	1518851	873,00			
Alumetallic	1514770	873,00			
Grigio Vulcano <b>NUOVO</b>	1527247	873,00			
Bianco	1514771	873,00			
Soft White <b>NUOVO</b>	1527064	873,00			
Caffè	1515095	873,00			
Profondità vasca: 190 mm					
<b>Fornitura:</b> vasca con pileta da 3½", tappo a cestello, saltarello e sifone					

BLANCO DALAGO 8 Silgranit	Incasso	Dettagli Colore / Finitura	Codice	Euro	 <b>80</b> cm base sottolavello
	 Sopratop	<b>BLANCO DALAGO 8</b>			
		Nero	1525877	748,00	
Antracite	1516629	748,00			
Grigio Roccia	1518852	748,00			
Alumetallic	1516630	748,00			
Grigio Vulcano <b>NUOVO</b>	1527248	748,00			
Bianco	1516633	748,00			
Soft White <b>NUOVO</b>	1527065	748,00			
Tartufo	1517323	748,00			
Caffè	1516638	748,00			
Dimensioni intaglio: 795x490 mm - R 15 Profondità vasca: 205 mm					
<b>Fornitura:</b> vasca con pileta da 3½", tappo a cestello, saltarello e sifone					

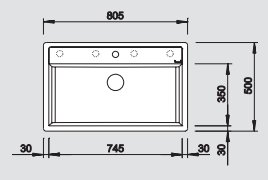
BLANCO DALAGO 8-F Silgranit	Incasso	Dettagli Colore / Finitura	Codice	Euro	 <b>80</b> cm base sottolavello
	 Incasso filotop	<b>BLANCO DALAGO 8-F</b>			
		Nero	1525878	953,00	
Antracite	1516639	953,00			
Grigio Roccia	1518853	953,00			
Alumetallic	1516640	953,00			
Grigio Vulcano <b>NUOVO</b>	1527249	953,00			
Bianco	1516644	953,00			
Soft White <b>NUOVO</b>	1527066	953,00			
Caffè	1516645	953,00			
Profondità vasca: 190 mm					
<b>Fornitura:</b> vasca con pileta da 3½", tappo a cestello, saltarello e sifone					

I lavelli contrassegnati con il simbolo  non possono essere montati a "inizio/fine composizione" nella base sottolavello indicata; possono essere invece facilmente inseriti in una base di misura superiore.  
**N.B.:** Per il montaggio su **piani di marmo**, ordinare l'apposito kit (v. pag. 258)

Accessori opzionali					
<b>Vaschetta angolare multifunzione</b> 	<b>Copertura scarico CapFlow</b> 	<b>Tagliere in legno massello di faggio</b> 	<b>Gocciolatoio sintetico nero</b> 	<b>Cestello inox con griglia per piatti</b> 	<b>Cestello in acciaio inox</b> 
Cod. 1235866 Euro 96,00	Cod. 1517666 Euro 39,00	Cod. 1232817 Euro 205,00	Cod. 1230734 Euro 85,00	Cod. 1507829 Euro 239,00	Cod. 1514238 Euro 130,00

LAVELLI  
SILGRANIT

# BLANCO SONA

Urban style con l'inconfondibile qualità BLANCO.



LAVELLI  
SILGRANIT

Mostrato nel colore:  
**Soft White**



BLANCO SONA 45 S



BLANCO SONA 5 S



BLANCO SONA XL 6 S



BLANCO SONA 8



BLANCO SONA 9



BLANCO SONA 8 S





BLANCO SONA in SILGRANIT®. Il design moderno della famiglia di lavelli, è creato per soddisfare le esigenze più specifiche.  
 La scelta fra 7 modelli facilmente inseribili in basi con larghezza standard, ne facilita l'integrazione nelle ambientazioni più diverse.  
 BLANCO SONA è disponibile in 9 accattivanti colori SILGRANIT®.



BLANCO SONA 5 S è caratterizzato dalla sua ampia vasca e dal gocciolatoio, che permette di lavare e preparare il cibo in tutta comodità - grazie anche agli accessori opzionali, come il tagliere a ponte in legno massello..

LAVELLI  
SILGRANIT



Tipologia  
di incasso:

**COLORI DISPONIBILI PER BLANCO SONA:**



BLANCO SONA 6 S



Nero

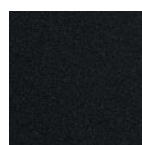

Antracite



Grigio Roccia



Alumatico



Grigio Vulcano

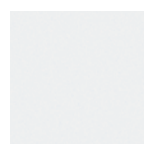

Bianco



Soft White



Tartufo\*\*

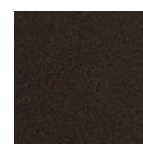

Caffè

ATTENZIONE! Le tonalità dei colori sono puramente indicative; per gli abbinamenti, usare SOLO le tabelle colori, disponibili a richiesta.

\*\*colore Tartufo disponibile solo per alcuni modelli

**BLANCO SONA 45 S  
Silgranit**



Accessori idonei



Incasso	Dettagli Colore / Finitura	Codice	Euro
 Sopratop	Nero	1525970	562,00
	Antracite	1519662	562,00
	Grigio Roccia	1519663	562,00
	Alumetallic	1519664	562,00
	Grigio Vulcano <b>NUOVO</b>	1527332	562,00
	Bianco	1519665	562,00
	Soft White <b>NUOVO</b>	1527149	562,00
	Tartufo	1519669	562,00
	Caffè	1519670	562,00

Dimensioni intaglio: 760x480 mm - R 15  
Profondità vasca: 205 mm

Fornitura: vasca con piletta da 3½", sifone e tappo a cestello

**Modello reversibile**

 **45** cm base sottolavello

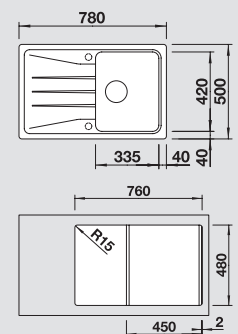

**BLANCO SONA 5 S  
Silgranit**



Accessori idonei



Incasso	Dettagli Colore / Finitura	Codice	Euro
 Sopratop	Nero	1525972	567,00
	Antracite	1519671	567,00
	Grigio Roccia	1519672	567,00
	Alumetallic	1519673	567,00
	Grigio Vulcano <b>NUOVO</b>	1527334	567,00
	Bianco	1519674	567,00
	Soft White <b>NUOVO</b>	1527151	567,00
	Tartufo	1519678	567,00
	Caffè	1519679	567,00

Dimensioni intaglio: 840x480 mm - R 15  
Profondità vasca: 205 mm

Fornitura: vasca con piletta da 3½", sifone e tappo a cestello

**Modello reversibile**

 **50** cm base sottolavello

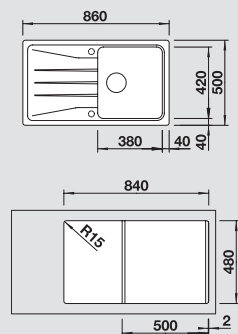

**BLANCO SONA XL 6 S  
Silgranit**



Accessori idonei



Incasso	Dettagli Colore / Finitura	Codice	Euro
 Sopratop	Nero	1525977	579,00
	Antracite	1519689	579,00
	Grigio Roccia	1519690	579,00
	Alumetallic	1519691	579,00
	Grigio Vulcano <b>NUOVO</b>	1527341	579,00
	Bianco	1519692	579,00
	Soft White <b>NUOVO</b>	1527158	579,00
	Tartufo	1519696	579,00
	Caffè	1519697	579,00

Dimensioni intaglio: 980x480 mm - R 15  
Profondità vasca: 205 mm

Fornitura: vasca con piletta da 3½", sifone e tappo a cestello

**Modello reversibile**

 **60** cm base sottolavello

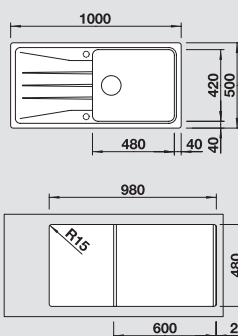

**BLANCO SONA 6 S  
Silgranit**



Accessori idonei



Incasso	Dettagli Colore / Finitura	Codice	Euro
 Sopratop	Nero	1525975	601,00
	Antracite	1519852	601,00
	Grigio Roccia	1519853	601,00
	Alumetallic	1519854	601,00
	Grigio Vulcano <b>NUOVO</b>	1527337	601,00
	Bianco	1519855	601,00
	Soft White <b>NUOVO</b>	1527154	601,00
	Tartufo	1519858	601,00
	Caffè	1519859	601,00

Dimensioni intaglio: 980x480 mm - R 15  
Profondità vasche: 205/115 mm

Fornitura: vasca con piletta da 3½", sifone e tappo a cestello

**Modello reversibile**

 **60** cm base sottolavello

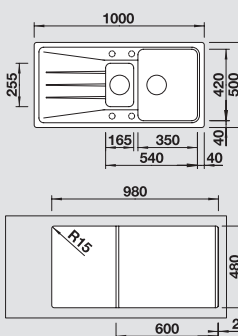

**BLANCO UNIT con BLANCO SONA**





Cod. 1526937  
Euro 282,00







Cod. 1526204  
Euro 533,00

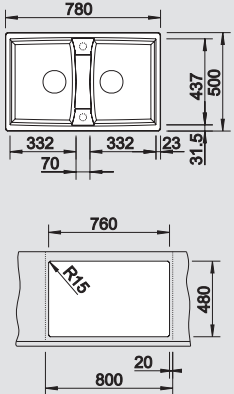

Cod. 1526647  
Euro 965,00

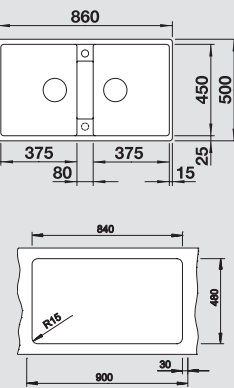

BLANCO SONA 8 Silgranit	Incasso	Dettagli Colore / Finitura	Codice	Euro	 <b>80</b> cm base sottolavello
	 Sopratop	Nero	1556182	584,00	
		Antracite	1534700	584,00	
		Alumetallic	1534693	584,00	
		Grigio Vulcano <b>NUOVO</b>	1557280	584,00	
		Bianco	1534694	584,00	
		Soft White <b>NUOVO</b>	1557097	584,00	
		Caffè	1535063		
Accessori idonei <input type="checkbox"/> 2 <input type="checkbox"/> 3 <input type="checkbox"/> 4 <input type="checkbox"/> 5 <input type="checkbox"/> 6					
Dimensioni intaglio: 760x480 mm- R 15 Profondità vasche: 205 mm Fornitura: vasca con piletta da 3½", sifone e tappo a cestello <b>Modello reversibile</b>					

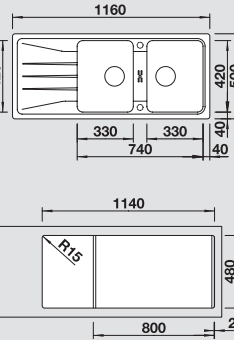
BLANCO SONA 9 Silgranit	Incasso	Dettagli Colore / Finitura	Codice	Euro	<b>90</b> cm base sottolavello
	 Sopratop	Nero	1546029	589,00	
		Antracite	1536686	589,00	
		Alumetallic	1536677	589,00	
		Grigio Vulcano <b>NUOVO</b>	1547393	589,00	
		Bianco	1536678	589,00	
		Soft White <b>NUOVO</b>	1547210	589,00	
		Caffè	1536683	589,00	
Accessori idonei <input type="checkbox"/> 1 <input type="checkbox"/> 2 <input type="checkbox"/> 3					
Dimensioni intaglio: 840x480 - R 15 Profondità vasche: 205 mm Fornitura: vasche con piletta da 3½", sifone e tappo a cestello					

BLANCO SONA 8 S Silgranit	Incasso	Dettagli Colore / Finitura	Codice	Euro	 <b>80</b> cm base sottolavello
	 Sopratop	Nero	1525979	630,00	
		Antracite	1519698	630,00	
		Grigio Roccia	1519699	630,00	
		Alumetallic	1519700	630,00	
		Grigio Vulcano <b>NUOVO</b>	1527339	630,00	
		Bianco	1519701	630,00	
		Soft White <b>NUOVO</b>	1527156	630,00	
		Tartufo	1519705	630,00	
		Caffè	1519706	630,00	
		Accessori idonei <input type="checkbox"/> 1 <input type="checkbox"/> 2 <input type="checkbox"/> 3 <input type="checkbox"/> 4			
Dimensioni intaglio: 1140x480 mm- R 15 Profondità vasche: 205 mm Fornitura: vasche con piletta da 3½", sifone e tappo a cestello <b>Modello reversibile</b>					

I lavelli contrassegnati con il simbolo  non possono essere montati a "inizio/fine composizione" nella base sottolavello indicata; possono essere invece facilmente inseriti in una base di misura superiore.

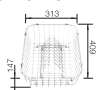
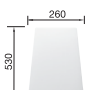
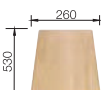
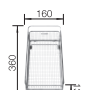
**N.B.:** Per il montaggio su **piani di marmo**, ordinare l'apposito kit (v. pag. 258)

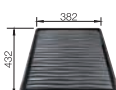
Accessori opzionali					
<b>Cestello inox con griglia per piatti</b>	<b>Tagliere a ponte in materiale sintetico</b>	<b>Tagliere a ponte in legno massello</b>	<b>Cestello inox multifunzione</b>	<b>Vaschetta forata in acciaio inox</b>	<b>Gocciolatoio sintetico nero</b>
					
Cod. 1507829 Euro 239,00	Cod. 1217611 Euro 142,00	Cod. 1218313 Euro 136,00	Cod. 1223297 Euro 215,00	Cod. 1231178 Euro 147,00	Cod. 1230734 Euro 85,00
<input type="checkbox"/> 1	<input type="checkbox"/> 2	<input type="checkbox"/> 3	<input type="checkbox"/> 4	<input type="checkbox"/> 5	<input type="checkbox"/> 6

LAVELLI SILGRANIT



# BLANCO ZIA

Un prezioso alleato in cucina, design ergonomico e massima funzionalità.



LAVELLI  
SILGRANIT

I lavelli BLANCO ZIA in SILGRANIT si caratterizzano per il loro design unico e senza tempo, moderno e dall'estetica lineare. Il Silgranit di BLANCO, è resistente agli sbalzi termici e alle alte temperature, e l'estrema omogeneità di questo materiale, privo di strati superficiali, lo rende molto resistente ai graffi e ai piccoli urti, facendo durare il lavello molto più a lungo nel tempo.



BLANCO ZIA XL 6 S: il massimo della capienza e del comfort, grazie alle vasche XL, unita alla versatilità degli accessori opzionali disponibili.

## COLORI DISPONIBILI PER BLANCO ZIA:

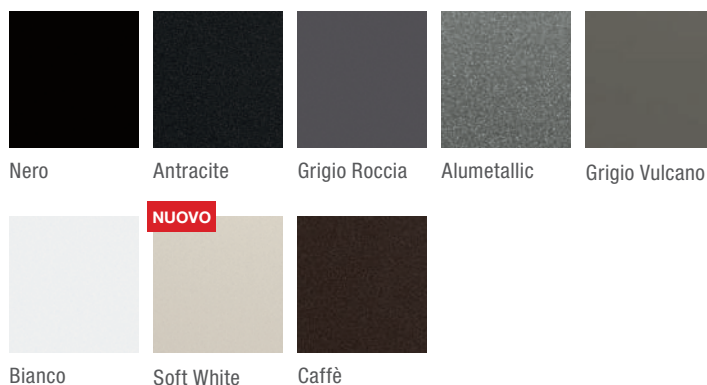

ATTENZIONE! Le tonalità dei colori sono puramente indicative; per gli abbinamenti, usare SOLO le tabelle colori, disponibili a richiesta.



**BLANCO ZIA 45 SL  
Silgranit**

**Accessori idonei**

**Incasso**

Sopratop

**Dettagli  
Colore / Finitura**

Colore / Finitura	Codice	Euro
Nero	1526011	562,00
Antracite	1516748	562,00
Alumetallic	1516739	562,00
Grigio Vulcano <b>NUOVO</b>	1527384	562,00
Bianco	1516740	562,00
Soft White <b>NUOVO</b>	1527201	562,00
Caffè	1516745	562,00

 Dimensioni intaglio: 840x480 - R 15  
 Profondità vasca: 205 mm

**Fornitura:** vasca con piletta da 3½", sifone e tappo a cestello

**Modello reversibile**

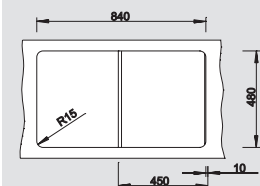
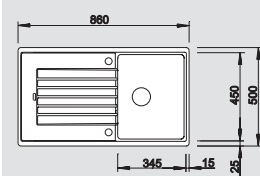
**45** cm base  
sottolavello

= Prefature

**BLANCO ZIA 5 S  
Silgranit**

**Accessori idonei**

**Incasso**



Sopratop

**Dettagli  
Colore / Finitura**

Colore / Finitura	Codice	Euro
Nero	1526016	567,00
Antracite	1520511	567,00
Alumetallic	1520513	567,00
Grigio Vulcano <b>NUOVO</b>	1527387	567,00
Bianco	1520515	567,00
Soft White <b>NUOVO</b>	1527204	567,00
Caffè	1520519	567,00

 Dimensioni intaglio: 840x480 mm - R 15  
 Profondità vasca: 205 mm

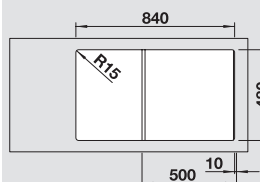
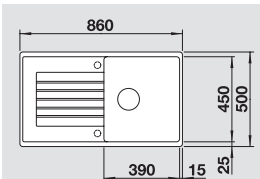
**Fornitura:** vasca con piletta da 3½", sifone e tappo a cestello

**Modello reversibile**
**50** cm base  
sottolavello

= Prefature

**BLANCO ZIA XL 6 S Compact  
Silgranit**

**Accessori idonei**

**Incasso**

Sopratop

**Dettagli  
Colore / Finitura**

Colore / Finitura	Codice	Euro
Nero	1526019	572,00
Antracite	1523273	572,00
Alumetallic	1523275	572,00
Grigio Vulcano <b>NUOVO</b>	1527397	572,00
Bianco	1523277	572,00
Soft White <b>NUOVO</b>	1527214	572,00
Caffè	1523282	572,00

 Dimensioni intaglio: 760x480 mm - R 15  
 Profondità vasche: 205 mm

**Fornitura:** vasche con piletta da 3½", sifone e tappo a cestello

**Modello reversibile**
**Colore Champagne non disponibile per questo modello.**

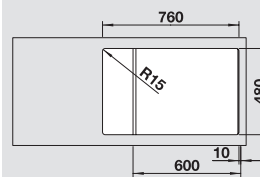
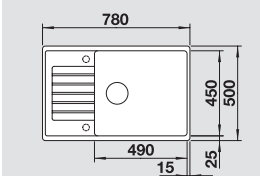
**60** cm base  
sottolavello

= Prefature

I lavelli contrassegnati con il simbolo non possono essere montati a "inizio/fine composizione" nella base sottolavello indicata; possono essere invece facilmente inseriti in una base di misura superiore.

**N.B.:** Per il montaggio su **piani di marmo**, ordinare l'apposito kit (v. pag. 258)

**Accessori opzionali**
**Tagliere a ponte  
in legno massello**

 Cod. 1218313  
Euro 136,00

1

**Vaschetta forata  
in acciaio inox**

 Cod. 1220736  
Euro 159,00

2

**Cestello inox  
con griglia per piatti**

 Cod. 1507829  
Euro 239,00

3

**Tagliere a ponte  
in materiale sintetico**

 Cod. 1217611  
Euro 142,00

4

**Cestello inox  
multifunzione**

 Cod. 1223297  
Euro 215,00

5

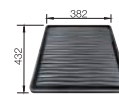
**Gocciolatoio  
sintetico nero**

 Cod. 1230734  
Euro 85,00

6

**BLANCO ZIA XL 6 S  
Silgranit**



Accessori idonei



Incasso	Dettagli Colore / Finitura	Codice	Euro
 Sopratop	Nero	1526024	579,00
	Antracite	1517568	579,00
	Alumetallic	1517569	579,00
	Grigio Vulcano <b>NUOVO</b>	1527400	579,00
	Bianco	1517571	579,00
	Soft White <b>NUOVO</b>	1527217	579,00
	Caffè	1517577	579,00

 Dimensioni intaglio: 980x480 mm - R 15  
 Profondità vasca: 205 mm

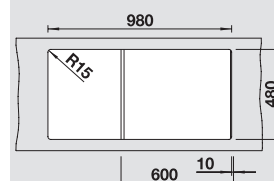
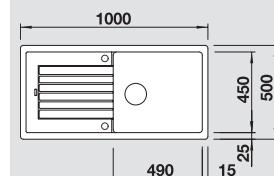
**Fornitura:** vasca con piletta da 3½", sifone e tappo a cestello

**Modello reversibile**
**60** cm base  
sottolavello

 = Preforature

**BLANCO ZIA 6 S  
Silgranit**



Accessori idonei



Incasso	Dettagli Colore / Finitura	Codice	Euro
 Sopratop	Nero	1526021	601,00
	Antracite	1514748	601,00
	Alumetallic	1514741	601,00
	Grigio Vulcano <b>NUOVO</b>	1527390	601,00
	Bianco	1514742	601,00
	Soft White <b>NUOVO</b>	1527207	601,00
	Caffè	1515072	601,00

 Dimensioni intaglio: 980x480 - R 15  
 Profondità vasche: 145/205 mm

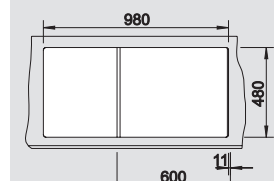
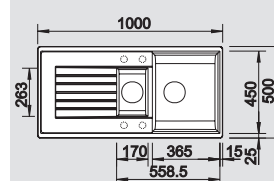
**Fornitura:** vasche con piletta da 3½", sifone e tappo a cestello

**Modello reversibile**
 **60** cm base  
sottolavello

 = Preforature

**BLANCO ZIA 8  
Silgranit**



Accessori idonei



Incasso	Dettagli Colore / Finitura	Codice	Euro
 Sopratop	Nero	1536182	584,00
	Antracite	1524700	584,00
	Alumetallic	1524693	584,00
	Grigio Vulcano <b>NUOVO</b>	1537280	584,00
	Bianco	1524694	584,00
	Soft White <b>NUOVO</b>	1537097	584,00
	Caffè	1525063	584,00

 Dimensioni intaglio: 760x480 mm - R 15  
 Profondità vasche: 205 mm

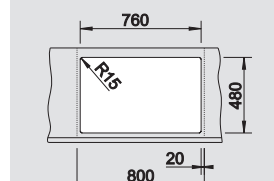
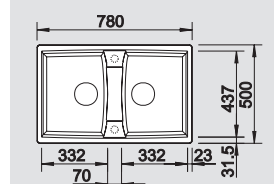
**Fornitura:** vasche con piletta da 3½", sifone e tappo a cestello

**Modello reversibile**
**Colore Champagne non disponibile per questo modello.**
 **80** cm base  
sottolavello

 = Preforature

**BLANCO UNIT con BLANCO ZIA**
**Miscelatore  
BLANCO ALTA Compact**

 Cod. 1526162  
 Euro 748,00

**Raccolta differenziata  
BLANCO SELECT II 60/3**

 Cod. 1526204  
 Euro 533,00

**Dissipatore BLANCO  
FWD Medium**

 Cod. 1526647  
 Euro 965,00

**NUOVO**

**BLANCO ZIA 9  
Silgranit**
**Incasso**
**Dettagli  
Colore / Finitura**
**Codice**
**Euro**
**90 cm base  
sottolavello**



Sopratop

Nero	1526029	589,00
Antracite	1516686	589,00
Alumetallic	1516677	589,00
Grigio Vulcano <b>NUOVO</b>	1527393	589,00
Bianco	1516678	589,00
Soft White <b>NUOVO</b>	1527210	589,00
Caffè	1516683	589,00

**Accessori idonei**

1 3 4 6

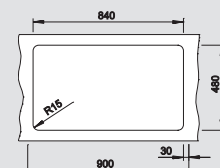
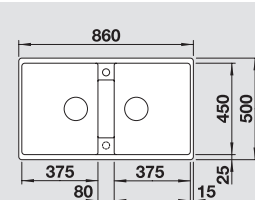
 Dimensioni intaglio: 840x480 - R 15  
 Profondità vasche: 205 mm

**Fornitura:** vasche con piletta da 3½", sifone e tappo a cestello

○ = Prefature

**BLANCO ZIA 8 S  
Silgranit**
**Incasso**
**Dettagli  
Colore / Finitura**
**Codice**
**Euro**
**80 cm base  
sottolavello**

Sopratop

Nero	1526027	630,00
Antracite	1515605	630,00
Alumetallic	1515596	630,00
Grigio Vulcano <b>NUOVO</b>	1527392	630,00
Bianco	1515597	630,00
Soft White <b>NUOVO</b>	1527209	630,00
Caffè	1515602	630,00

**Accessori idonei**

1 3 4 5

 Dimensioni intaglio: 1140x480 mm - R 15  
 Profondità vasche: 205 mm

**Fornitura:** vasche con piletta da 3½", sifone e tappo a cestello

**Modello reversibile**

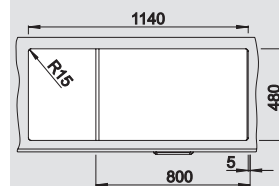
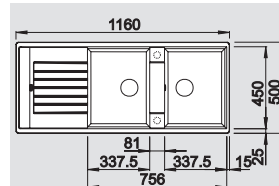
**80 cm base  
sottolavello**

○ = Prefature



I lavelli contrassegnati con il simbolo ⚠ non possono essere montati a "inizio/fine composizione" nella base sottolavello indicata; possono essere invece facilmente inseriti in una base di misura superiore.

**N.B.:** Per il montaggio su **piani di marmo**, ordinare l'apposito kit (v. pag. 258)

**Accessori opzionali**
**Tagliere a ponte  
in legno massello**

 Cod. 1218313  
 Euro 136,00

1

**Vaschetta forata  
in acciaio inox**

 Cod. 1220736  
 Euro 159,00

2

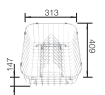
**Cestello inox  
con griglia per piatti**

 Cod. 1507829  
 Euro 239,00

3

**Tagliere a ponte  
in materiale sintetico**

 Cod. 1217611  
 Euro 142,00

4

**Cestello inox  
multifunzione**

 Cod. 1223297  
 Euro 215,00

5

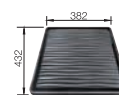
**Gocciolatoio  
sintetico nero**

 Cod. 1230734  
 Euro 85,00

6

# BLANCO LEGRA

Giovane e moderno, ideale per ogni tipo di cucina.



Lavello: BLANCO LEGRA XL 6 S, antracite

Miscelatore: BLANCO MILA-S, antracite

Mostrato nel colore:  
**Nero**



BLANCO LEGRA 45 S



BLANCO LEGRA XL 6 S



BLANCO LEGRA 6 S



BLANCO LEGRA 9



BLANCO LEGRA 8 S





I lavelli della famiglia BLANCO LEGRA si caratterizzano il loro design equilibrato e lineare, le vasche ampie e l'alta qualità del materiale. Lo stile asciutto, senza fronzoli, e i numerosi accessori disponibili esaltano la funzionalità di questi lavelli, in grado di agevolare tutte le operazioni che vengono svolte quotidianamente in cucina. I modelli di questa famiglia sono disponibili per tutte le dimensioni di base sottolavello per adattarsi a qualsiasi stile.



Design equilibrato, vasche ampie e alta qualità del materiale sono le caratteristiche principali dei lavelli della famiglia BLANCO LEGRA.

LAVELLI  
SIL GRANIT



BLANCO LEGRA 8

COLORI DISPONIBILI PER BLANCO LEGRA:



Nero

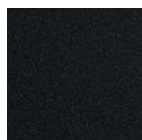

Antracite



Alumetallic



Grigio Vulcano

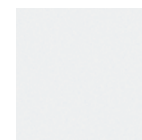

Bianco



Soft White

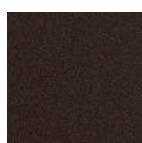

Caffè

ATTENZIONE! Le tonalità dei colori sono puramente indicative; per gli abbinamenti, usare SOLO le tabelle colori, disponibili a richiesta.



**BLANCO LEGRA 45 S**  
**Silgranit**



Accessori idonei

**Incasso**
**Dettagli**  
**Colore / Finitura**
**Codice**
**Euro**

Nero	1526083	545,00
Antracite	1522201	545,00
Alumetallic	1522202	545,00
Grigio Vulcano <b>NUOVO</b>	1527268	545,00
Bianco	1522203	545,00
Soft White <b>NUOVO</b>	1527085	545,00
Caffè	1522206	545,00

 Dimensioni intaglio: 760x480 mm - R 15  
 Profondità vasca: 205 mm

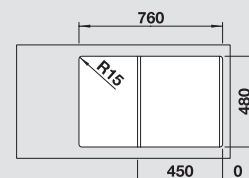
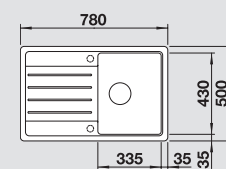
**Fornitura:** vasca con piletta da 3½", sifone e tappo a cestello

**Modello reversibile**
**45** cm base  
 sottolavello

= Preforature

**BLANCO LEGRA XL 6 S**  
**Silgranit**



Accessori idonei

**Incasso**
**Dettagli**  
**Colore / Finitura**
**Codice**
**Euro**

Nero	1526087	562,00
Antracite	1523326	562,00
Alumetallic	1523327	562,00
Grigio Vulcano <b>NUOVO</b>	1527274	562,00
Bianco	1523328	562,00
Soft White <b>NUOVO</b>	1527091	562,00
Caffè	1523331	562,00

 Dimensioni intaglio: 840x480 mm - R 15  
 Profondità vasca: 205 mm

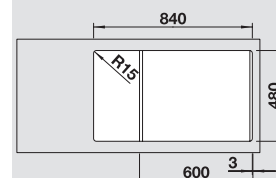
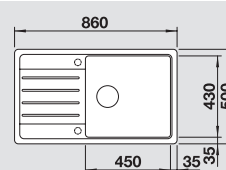
**Fornitura:** vasca con piletta da 3½", sifone e tappo a cestello

**Modello reversibile**
**60** cm base  
 sottolavello

= Preforature

**BLANCO LEGRA 6 S**  
**Silgranit**



Accessori idonei

**Incasso**
**Dettagli**  
**Colore / Finitura**
**Codice**
**Euro**

Nero	1526086	584,00
Antracite	1522207	584,00
Alumetallic	1522208	584,00
Grigio Vulcano <b>NUOVO</b>	1527271	584,00
Bianco	1522209	584,00
Soft White <b>NUOVO</b>	1527088	584,00
Caffè	1522212	584,00

 Dimensioni intaglio: 980x480 mm - R 15  
 Profondità vasca: 205 mm

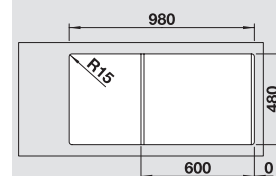
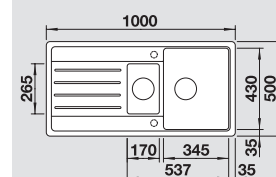
**Fornitura:** vasca con piletta da 3½", sifone e tappo a cestello

**Modello reversibile**
**60** cm base  
 sottolavello

= Preforature

**BLANCO UNIT con BLANCO LEGRA**
**Miscelatore**  
**BLANCO DARAS-S**

 Cod. 1526153  
 Euro 282,00

**Raccolta differenziata**  
**BLANCO FLEXON II 60/3**

 Cod. 1521472  
 Euro 312,00

**Dissipatore BLANCO**  
**FWD Lite**

 Cod. 1526646  
 Euro 681,00

**NUOVO**

**BLANCO LEGRA 8  
Silgranit**

Accessori idonei



**Incasso**

**Dettagli  
Colore / Finitura**

Incasso	Dettagli Colore / Finitura	Codice	Euro
	Nero	1546182	579,00
	Antracite	1544700	579,00
	Alumetallic	1544693	579,00
	Grigio Vulcano <b>NUOVO</b>	1547280	579,00
	Bianco	1544694	579,00
	Soft White <b>NUOVO</b>	1547097	579,00
	Caffè	1545063	579,00

 Dimensioni intaglio: 760x480 mm - R 15  
 Profondità vasca: 205 mm

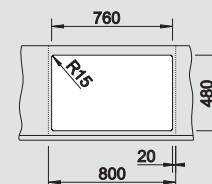
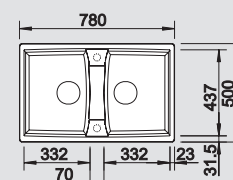
**Fornitura:** vasca con piletta da 3½", sifone e tappo a cestello

**80** cm base  
sottolavello

○ = Prefature

**BLANCO LEGRA 9  
Silgranit**

Accessori idonei



**Incasso**

**Dettagli  
Colore / Finitura**

Incasso	Dettagli Colore / Finitura	Codice	Euro
	Nero	1536029	589,00
	Antracite	1526686	589,00
	Alumetallic	1526677	589,00
	Grigio Vulcano <b>NUOVO</b>	1537393	589,00
	Bianco	1526678	589,00
	Soft White <b>NUOVO</b>	1537210	589,00
	Caffè	1526683	589,00

 Dimensioni intaglio: 840x480 mm - R 15  
 Profondità vasca: 205 mm

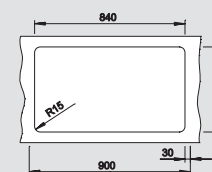
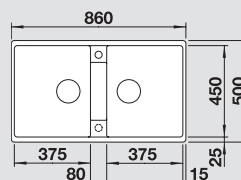
**Fornitura:** vasca con piletta da 3½", sifone e tappo a cestello

**90** cm base  
sottolavello

○ = Prefature

**BLANCO LEGRA 8 S  
Silgranit**

Accessori idonei

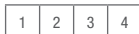

**Incasso**

**Dettagli  
Colore / Finitura**

Incasso	Dettagli Colore / Finitura	Codice	Euro
	Nero	1526088	606,00
	Antracite	1523163	606,00
	Alumetallic	1523164	606,00
	Grigio Vulcano <b>NUOVO</b>	1527273	606,00
	Bianco	1523165	606,00
	Soft White <b>NUOVO</b>	1527090	606,00
	Caffè	1523168	606,00

 Dimensioni intaglio: 1140x480 mm - R 15  
 Profondità vasca: 205 mm

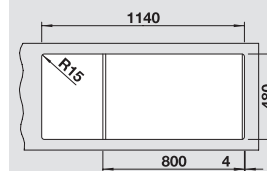
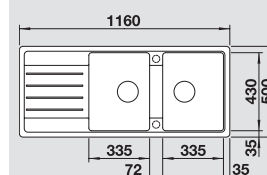
**Fornitura:** vasca con piletta da 3½", sifone e tappo a cestello

**Modello reversibile**
**80** cm base  
sottolavello

○ = Prefature

I lavelli contrassegnati con il simbolo non possono essere montati a "inizio/fine composizione" nella base sottolavello indicata; possono essere invece facilmente inseriti in una base di misura superiore.

**N.B.:** Per il montaggio su **piani di marmo**, ordinare l'apposito kit (v. pag. 258)

**Accessori opzionali**
**Copertura scarico  
CapFlow**

 Cod. 1517666  
 Euro 39,00

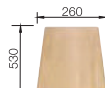
**Tagliere a ponte  
in legno massello**

 Cod. 1218313  
 Euro 136,00

1

**Tagliere a ponte  
in materiale sintetico**

 Cod. 1217611  
 Euro 142,00

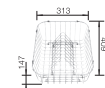
2

**Cestello inox  
con griglia per piatti**

 Cod. 1507829  
 Euro 239,00

3

**Cestello inox  
multifunzione**

 Cod. 1223297  
 Euro 215,00

4











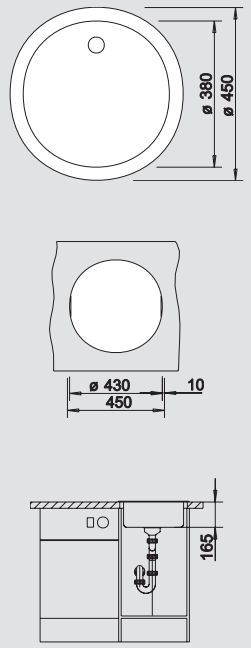

# BLANCORONDO

SILGRANIT

## Colore e praticità anche in spazi ridotti

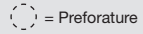
- Disponibile in 6 differenti colori per adattarsi a qualsiasi stile
- Cestello in acciaio inox disponibile come accessorio
- Particolarmente adatto ad ambienti con dimensioni ridotte

BLANCORONDO Silgranit	Incasso	Dettagli Colore / Finitura	Codice	Euro	 <b>45</b> cm base sottolavello
	 Sopratop	Nero	1525959	533,00	
		Antracite	1511629	533,00	
		Alumetallic	1511704	533,00	
		Grigio Vulcano <b>NUOVO</b>	1527240	533,00	
		Bianco	1511621	533,00	
		Soft White <b>NUOVO</b>	1527057	533,00	
		Caffè	1515028	533,00	
<p>Dimensioni intaglio: 430 mm di diametro Profondità vasca: 165 mm</p> <p><b>Fornitura:</b> vasca con pileta da 3½", tappo a cestello e sifone</p>					 = Preforature

I lavelli contrassegnati con il simbolo  non possono essere montati a "inizio/fine composizione" nella base sottolavello indicata; possono essere invece facilmente inseriti in una base di misura superiore.

**N.B.:** Per il montaggio su **piani di marmo**, ordinare l'apposito kit (v. pag. 258)

**ATTENZIONE!** Le tonalità dei colori sono puramente indicative; per gli abbinamenti, usare SOLO le tabelle colori, disponibili a richiesta.

### BLANCO UNIT con BLANCO RONDO

Miscelatore  
BLANCO MIDA



Cod. 1519418  
Euro 223,00

BLANCO BOTTON Pro  
45/2 Manuale



Cod. 1517467  
Euro 210,00

Dissipatore BLANCO  
FWD Lite



Cod. 1526646  
Euro 681,00

**NUOVO**

### Accessori opzionali

Copertura scarico  
CapFlow



Cod. 1517666  
Euro 39,00

Cestello  
in acciaio inox



Cod. 1220574  
Euro 113,00



# CLASSICO. SENZA TEMPO. ELEGANTE.

Vasche e lavelli in acciaio inox.



I lavelli in acciaio inox sono eleganti e senza tempo, e sono i preferiti dai progettisti di cucine. Oltre alle sue proprietà, idonee per la preparazione del cibo e per lavare i piatti, l'acciaio inossidabile offre anche numerose opzioni di design e caratteristiche del prodotto, come angoli arrotondati o stretti, diverse profondità della vasca e forma del lavello. Un'ampia gamma di stili apre infinite possibilità per trovare il lavello giusto per ogni cucina, mentre i toni neutri dell'acciaio inox si sposano armoniosamente con qualsiasi ambiente cucina.

LAVELLI  
INOX



L'acciaio inox è igienico, la sua superficie è liscia al tatto, è resistente e privo di pori, il che lo rende eccezionalmente facile da mantenere. La qualità premium dell'acciaio inossidabile BLANCO rende i nostri lavelli sicuri per l'uso alimentare. Ha una resistenza naturale agli acidi di comune uso domestico (come l'acido acetico o l'acido citrico) e alle macchie dovute, per es. a caffè, tè, o gli acidi della frutta. Puoi preparare il cibo sulla sua superficie in tranquillità.



L'acciaio inox è robusto. I piatti o i vasi che accidentalmente cadono su di esso, non si rompono facilmente. Appoggiare pentole calde o versare acqua bollente nel lavandino non influirà sulla sua superficie resistente al calore. Con la minima cura necessaria, i lavelli in acciaio inossidabile manterranno la loro brillantezza e saranno sempre perfetti per decenni.

# BLANCO DIVON II -IF

Massima raffinatezza in cucina.



LAVELLI  
INOX

Lavello: BLANCO DIVON 6 S-IF

Miscelatore: BLANCO CATRIS-S, cromato



BLANCO DIVON II 45 S-IF



BLANCO DIVON II 5 S-IF



BLANCO DIVON II 6 S-IF



BLANCO DIVON II 8-IF



BLANCO DIVON II 8 S-IF





Le vasche quadrate, con **raggio da 10 mm** e il profilo interno ribassato, aumentano la praticità di ogni modello BLANCO DIVON II. Le vasche rifinite a mano, aggiungono la preziosità del lavoro artigianale alla più elevata tecnologia nella lavorazione dell'acciaio inox 18/10.

Il sistema di **scarico InFino** è integrato in tutte vasche.

Queste caratteristiche fanno di BLANCO DIVON II la migliore soluzione di estetica, design e funzionalità.



La nuova **griglia pieghevole multifunzione** offre una superficie di lavoro aggiuntiva per un maggiore comfort durante la preparazione.



L'ampio gocciolatoio offre tanto spazio per scolare pentole, piatti e bicchieri.

La nuova griglia pieghevole multifunzione offre:

- una superficie di lavoro aggiuntiva per una maggiore ergonomia durante la preparazione
- la comodità di lasciare asciugare le stoviglie e drenare l'acqua direttamente nella vasca

Scopri di più su: [www.blanco.com/it](http://www.blanco.com/it)

**BLANCO DIVON II 45 S-IF**  
Acciaio Inox 18/10



Accessori idonei:



Scarico InFino®  
integrato di serie

KIT COMANDO  
SALTARELLO  
INCLUSO

**Incasso**

**Dettagli**  
Colore / Finitura

**Codice**

**Euro**



Sopratop  
bordo 1 mm  
e filotop

Vasca DX - Confezione in cartone  
Vasca SX - Confezione in cartone

1519816 1.004,00  
1519815 1.004,00

Dimensioni intaglio per incasso sopratop: 840x490 mm - R 15  
Profondità vasca: 195 mm  
Raggio interno/esterno: 10 mm

**Fornitura:** vasca con piletta da 3½", sifone, tappo a cestello InFino®  
e saltarello

**45** cm base  
sottolavello

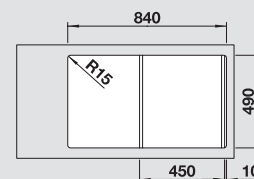
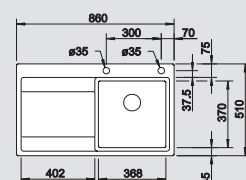

**BLANCO DIVON II 5 S-IF**  
Acciaio Inox 18/10



Accessori idonei:



Scarico InFino®  
integrato di serie

KIT COMANDO  
SALTARELLO  
INCLUSO

**Incasso**

**Dettagli**  
Colore / Finitura

**Codice**

**Euro**



Sopratop  
bordo 1 mm  
e filotop

Vasca DX - Confezione in cartone  
Vasca SX - Confezione in cartone

1519818 1.043,00  
1519817 1.043,00

Dimensioni intaglio per incasso sopratop: 980x490 mm - R 15  
Profondità vasca: 195 mm  
Raggio interno/esterno: 10 mm

**Fornitura:** vasca con piletta da 3½", sifone, tappo a cestello InFino®  
e saltarello

**50** cm base  
sottolavello

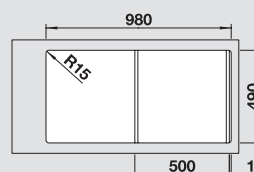
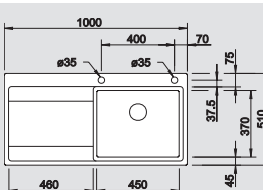

**BLANCO DIVON II 6 S-IF**  
Acciaio Inox 18/10



Accessori idonei:



Scarico InFino®  
integrato di serie

KIT COMANDO  
SALTARELLO  
INCLUSO

**Incasso**

**Dettagli**  
Colore / Finitura

**Codice**

**Euro**



Sopratop  
bordo 1 mm  
e filotop

Vasca DX - Confezione in cartone  
Vasca SX - Confezione in cartone

1519820 1.305,00  
1519819 1.305,00

Dimensioni intaglio per incasso sopratop: 980x490 mm - R 15  
Profondità vasche: 135/195 mm  
Raggio interno/esterno 10 mm

**Fornitura:** vasche con piletta da 3½", sifone, tappo a cestello InFino®  
e saltarello per vasca principale, vaschetta forata in acciaio inox mod. 3

**60** cm base  
sottolavello

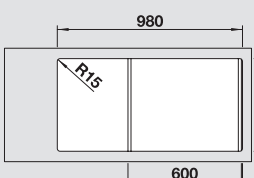
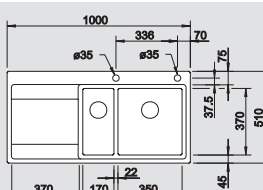

**BLANCO UNIT con BLANCO DIVON II -IF**

Miscelatore  
BLANCO LINUS-S



Cod. 1512402  
Euro 431,00

Dispenser di sapone  
BLANCO TORRE



Cod. 1512593  
Euro 181,00

Raccolta differenziata  
BLANCO SELECT XL 60/3



Cod. 1526205  
Euro 545,00

Dissipatore BLANCO  
FWD Max



Cod. 1526648  
Euro 1.248,00

**NUOVO**



**BLANCO DIVON II 8-IF**  
Acciaio Inox 18/10

**Incasso**

**Dettagli**  
Colore / Finitura

**Codice**

**Euro**



**80** cm base  
sottolavello



Sopratop  
bordo 1 mm  
e filotop

Confezione in cartone

1519821

1.265,00

Dimensioni intaglio per incasso sopratop: 840x490 mm - R 15  
Profondità vasche: 195 mm  
Raggio interno/esterno: 10 mm

**Fornitura:** vasche con piletta da 3½", sifone, tappo a cestello InFino e saltarello per una vasca

Accessori idonei:



**Scarico InFino**  
integrato di serie

KIT COMANDO  
SALTARELLO  
INCLUSO

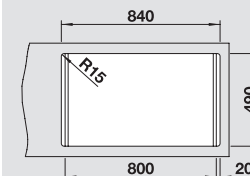
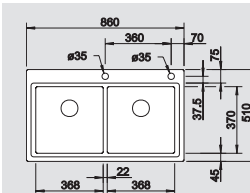

**BLANCO DIVON II 8 S-IF**  
Acciaio Inox 18/10

**Incasso**

**Dettagli**  
Colore / Finitura

**Codice**

**Euro**



**80** cm base  
sottolavello



Sopratop  
bordo 1 mm  
e filotop

Vasca DX - Confezione in cartone

1519823

1.315,00

Vasca SX - Confezione in cartone

1519822

1.315,00

Dimensioni intaglio per incasso sopratop: 1140x490 mm - R 15  
Profondità vasche: 195 mm  
Raggio interno/esterno: 10 mm

**Fornitura:** vasche con piletta da 3½", sifone, tappo a cestello InFino e saltarello per una vasca

Accessori idonei:



**Scarico InFino**  
integrato di serie

KIT COMANDO  
SALTARELLO  
INCLUSO

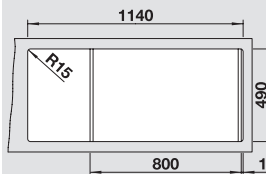
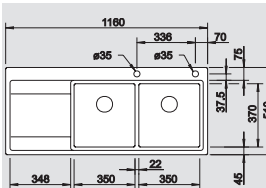

LAVELLI  
INOX

I lavelli contrassegnati con il simbolo non possono essere montati a "inizio/fine composizione" nella base sottolavello indicata; possono essere invece facilmente inseriti in una base di misura superiore.

**Accessori opzionali**

**Gocciolatoio**  
sintetico nero

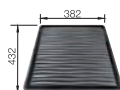

Cod. 1230734  
Euro 85,00

1

**Tagliere in cristallo**  
satinato silver



Cod. 1230970  
Euro 420,00

2

**Vaschetta forata in acciaio**  
inox 18/10



Cod. 1231396  
Euro 222,00

3

**Griglia pieghevole**  
multifunzione



Cod. 1238483  
Euro 193,00

4

# BLANCO CLASSIMO-IF

Tutto il fascino del design.



LAVELLI  
INOX

Lavello: BLANCO CLASSIMO XL 6 S-IF  
Miscelatore: BLANCO LINUS-S, cromato



BLANCO CLASSIMO 45 S-IF



BLANCO CLASSIMO 6 S-IF



BLANCO CLASSIMO XL 6 S-IF



BLANCO CLASSIMO 8-IF



BLANCO CLASSIMO 8 S-IF





Perfetto per fascino e dotazione. BLANCO CLASSIMO -IF è la famiglia di lavelli per incasso a filotop e sopratop dal design classico, interpretato in chiave moderna, a cui l'acciaio inox dona un fascino particolare.

Oltre all'aspetto esteriore, questa nuova gamma di lavelli punta su comfort e funzionalità grazie alle sue ingegnose soluzioni: la spaziosa vasca principale e, in alcuni modelli, una comoda vasca aggiuntiva laterale. La fornitura in dotazione è un punto di forza di questa gamma di lavelli: lo scarico **InFino**, il comando a saltarello **PushControl** e il troppopieno rettangolare offrono un look estremamente raffinato, unitamente a una maggiore semplicità di utilizzo.



Le ampie vasche dei lavelli BLANCO CLASSIMO colpiscono per la praticità e la funzionalità grazie all'ampio spazio, che permette di svolgere le attività di risciacquo e lavaggio comodamente.



CLASSIMO 6 S-IF: grande vasca principale e vasca aggiuntiva, che permette il risciacquo dei cibi in tutta comodità.



Eccezionale dotazione di serie: scarico InFino, PushControl e troppopieno rettangolare.

**BLANCO CLASSIMO 45 S-IF**  
Acciaio Inox 18/10



Accessori idonei:

1



Scarico InFino a saltarello integrato con comando PushControl di serie

Incasso



Sopratop e filotop

Dettagli  
Colore / Finitura

Confezione in cartone

Dimensioni intaglio per incasso sopratop: 840x480 mm - R 15  
Profondità vasca: 205 mm

**Fornitura:** vasca con piletta da 3½", scarico InFino, comando PushControl e sifone. Completo di 2 fori.

**Modello reversibile**

Codice

1525330

Euro

471,00

**45** cm base  
sottolavello

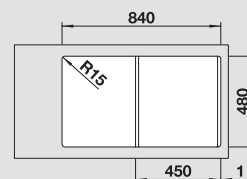
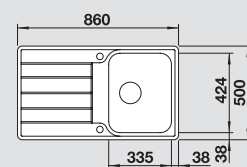

**BLANCO CLASSIMO 6 S-IF**  
Acciaio Inox 18/10



Accessori idonei:

1 2



Scarico InFino a saltarello integrato con comando PushControl di serie



Sopratop e filotop

Confezione in cartone

Dimensioni intaglio per incasso sopratop: 980x480 mm - R 15  
Profondità vasche: 145/205 mm

**Fornitura:** vasca con piletta da 3½", scarico InFino, comando PushControl per vasca principale e sifone. Completo di 2 fori.

**Modello reversibile**

Codice

1525328

Euro

555,00

**60** cm base  
sottolavello

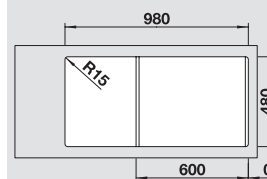
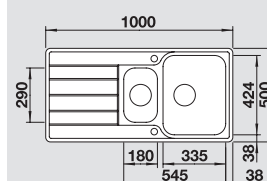

**BLANCO CLASSIMO XL 6 S-IF**  
Acciaio Inox 18/10



Accessori idonei:

1



Scarico InFino a saltarello integrato con comando PushControl di serie



Sopratop e filotop

Confezione in cartone

Dimensioni intaglio per incasso sopratop: 980x480 mm - R 15  
Profondità vasca: 205 mm

**Fornitura:** vasca con piletta da 3½", scarico InFino, comando PushControl e sifone. Completo di 2 fori.

**Modello reversibile**

Codice

1525327

Euro

528,00

**60** cm base  
sottolavello

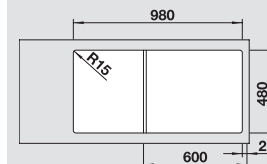
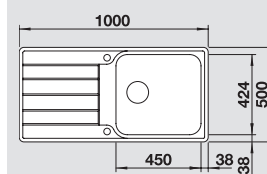

**BLANCO UNIT con BLANCO CLASSIMO -IF**

Miscelatore  
BLANCO CARENA-S



Cod. 1520767  
Euro 720,00

Dispenser di sapone  
BLANCO TANGO



Cod. 1511266  
Euro 147,00

Raccolta differenziata  
BLANCO SELECT II 60/2



Cod. 1526203  
Euro 522,00

**NUOVO**

Dissipatore BLANCO  
FWD Medium



Cod. 1526647  
Euro 965,00

**NUOVO**



**BLANCO CLASSIMO 8-IF**  
Acciaio Inox 18/10

Incasso

Dettagli  
Colore / Finitura

Codice

Euro

**80** cm base  
sottolavello



Sopratop  
e filtop

Confezione in cartone

1525331

584,00

Dimensioni intaglio per incasso sopratop: 840x480 mm - R 15  
Profondità vasche: 205/205 mm

**Fornitura:** vasca con piletta da 3½", scarico InFino, comando PushControl per una vasca e sifone. Completo di 2 fori.

**Modello reversibile**

Accessori idonei:

1



Scarico InFino a saltarello  
integrato con comando  
PushControl di serie

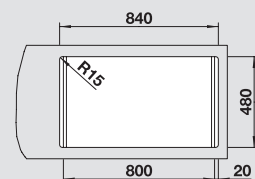
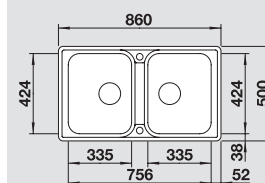

**BLANCO CLASSIMO 8 S-IF**  
Acciaio Inox 18/10

Incasso

Dettagli  
Colore / Finitura

Codice

Euro

**80** cm base  
sottolavello



Sopratop  
e filtop

Confezione in cartone

1525332

647,00

Dimensioni intaglio per incasso sopratop: 1140x480 mm - R 15  
rofondità vasche: 205/205 mm

**Fornitura:** vasca con piletta da 3½", scarico InFino, comando PushControl per una vasca e sifone. Completo di 2 fori.

**Modello reversibile**

Accessori idonei:

1



Scarico InFino a saltarello  
integrato con comando  
PushControl di serie

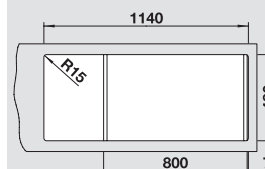
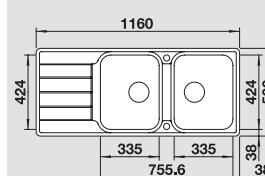

**BLANCO CLASSIMO 6 S-IF**  
con scarico InFino e saltarello PushControl

LAVELLI  
INOX

I lavelli contrassegnati con il simbolo  non possono essere montati a "inizio/fine composizione" nella base sottolavello indicata; possono essere invece facilmente inseriti in una base di misura superiore.

**In dotazione**

BLANCO  
PushControl



COMPRESO

**Accessori opzionali**

Kit ganci per top di spessore  
da 15 a 30 mm (10 pz.)



Cod. 1223742  
Euro 15,00

Cestello inox  
con griglia per piatti



Cod. 1507829  
Euro 239,00

Vaschetta forata  
in acciaio inox



Cod. 1240729  
Euro 96,00

1

2

# BLANCO LEMIS-IF

Sorprendente e affidabile.



LAVELLI  
INOX

Lavello: BLANCO LEMIS 45 S-IF

Miscelatore: BLANCO AMBIS-S



BLANCO LEMIS 45 S-IF



BLANCO LEMIS XL 6 S-IF Compact



BLANCO LEMIS XL 6 S-IF



BLANCO LEMIS 6 S-IF



BLANCO LEMIS 6-IF



BLANCO LEMIS 8-IF



BLANCO LEMIS 8 S-IF



Questa nuova linea di prodotti in acciaio inox si distingue per il design estremamente elegante. Tutti i modelli BLANCO LEMIS dispongono di una grande vasca principale con **raggio ridotto (60 mm)** e di un ampio gocciolatoio (escluso BLANCO LEMIS 8). Così risciacquare e far sgocciolare le stoviglie, anche di grandi dimensioni, sarà semplice e comodo. La serie BLANCO LEMIS è **reversibile** e può essere installata sia sopra-top, sia a filotop. La forma e l'elegante esecuzione con bordi ultrapiatti la rende perfetta in ogni ambiente cucina. In linea con i trend più attuali, BLANCO propone anche una variante con grande vasca in formato XL per una maggiore libertà di movimento e più spazio nel lavello.



La generosa vasca XL di BLANCO LEMIS XL 6 S offre spazio sufficiente anche per le pentole più ingombranti, così come il grande gocciolatoio: una praticità senza limiti!

LAVELLI  
INOX



Ampia libertà di movimento per pulire e risciacquare le stoviglie nella vasca XL di BLANCO LEMIS XL.



Anche il gocciolatoio offre tanto spazio: la superficie perfetta dove lasciar sgocciolare le stoviglie, grazie anche agli utili accessori come il cestello in acciaio inox con griglia per piatti.



**BLANCO LEMIS 45 S-IF**  
Acciaio Inox 18/10



**Accessori idonei:**

1



KIT COMANDO  
SALTARELLO  
INCLUSO

**Incasto**



Sopratop  
e filotop

**Dettagli**  
Colore / Finitura

Confezione in cartone

**Codice**

1523031

**Euro**

346,00

Dimensioni intaglio per incasso sopratop: 840x480 mm - R 15  
Raggio interno: 60 mm  
Raggio fondo vasca: 30 mm  
Profondità vasca: 205 mm

**Fornitura:** vasca con piletta da 3½", tappo a cestello, saltarello e sifone.  
Completo di 2 fori.

**Modello reversibile**



**45** cm base  
sottolavello

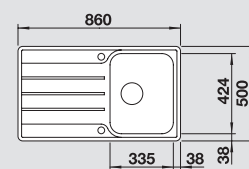

**BLANCO LEMIS XL 6 S-IF Compact**  
Acciaio Inox 18/10



**Accessori idonei:**

1



KIT COMANDO  
SALTARELLO  
INCLUSO

**Incasto**



Sopratop  
e filotop

**Dettagli**  
Colore / Finitura

Confezione in cartone

**Codice**

1525110

**Euro**

420,00

Dimensioni intaglio per incasso sopratop: 760x480 mm - R 15  
Raggio interno: 60 mm  
Raggio fondo vasca: 30 mm  
Profondità vasca: 205 mm

**Fornitura:** vasca con piletta da 3½", tappo a cestello, saltarello e sifone.  
Completo di 2 fori.

**Modello reversibile**



**60** cm base  
sottolavello

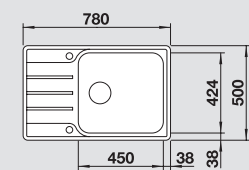

**BLANCO LEMIS XL 6 S-IF**  
Acciaio Inox 18/10



**Accessori idonei:**

1



KIT COMANDO  
SALTARELLO  
INCLUSO

**Incasto**



Sopratop  
e filotop

**Dettagli**  
Colore / Finitura

Confezione in cartone

**Codice**

1523035

**Euro**

442,00

Dimensioni intaglio per incasso sopratop: 980x480 mm - R 15  
Raggio interno: 60 mm  
Raggio fondo vasca: 30 mm  
Profondità vasca: 205 mm

**Fornitura:** vasca con piletta da 3½", tappo a cestello, saltarello e sifone.  
Completo di 2 fori.

**Modello reversibile**

**60** cm base  
sottolavello

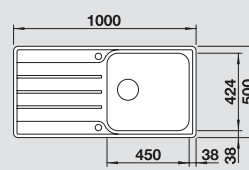

**BLANCO LEMIS 6-IF**  
Acciaio Inox 18/10



**Accessori idonei:**

1 3



KIT COMANDO  
SALTARELLO  
INCLUSO

**Incasto**



Sopratop  
e filotop

**Dettagli**  
Colore / Finitura

Confezione in cartone

**Codice**

1525109

**Euro**

488,00

Dimensioni intaglio per incasso sopratop: 595x480 mm - R 15  
Raggio interno: 60 mm  
Raggio fondo vasca: 30 mm  
Profondità vasca: 190 mm

**Fornitura:** vasca con piletta da 3½", tappo a cestello, saltarello e sifone.  
Completo di 2 fori.

**60** cm base  
sottolavello

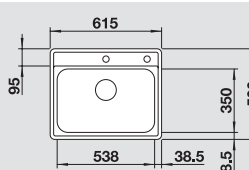

**BLANCO UNIT con BLANCO LEMIS-IF**

**Miscelatore**  
BLANCO CARENA-S



Cod. 1520767  
Euro 720,00

**Dispenser di sapone**  
BLANCO TANGO



Cod. 1511266  
Euro 147,00

**Raccolta differenziata**  
BLANCO FLEXON II 60/3 Low



Cod. 1526642  
Euro 239,00

**Dissipatore BLANCO**  
FWD Medium





Cod. 1526647  
Euro 965,00



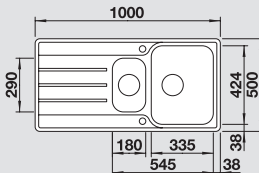
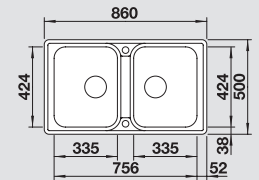

**NUOVO**

**NUOVO**



<p><b>BLANCO LEMIS 6 S-IF</b> Acciaio Inox 18/10</p>  <p><b>Accessori idonei:</b> 1 2 KIT COMANDO SALTARELLO INCLUSO</p>	<p><b>Incasso</b></p> <p><b>Dettagli Colore / Finitura</b></p> <p>Confezione in cartone</p> <p>Dimensioni intaglio per incasso sopra-top: 980x480 mm - R 15 Raggio interno: 60 mm Raggio fondo vasca: 30 mm Profondità vasche: 205/145 mm</p> <p><b>Fornitura:</b> vasche con piletta da 3½", tappo a cestello, saltarello e sifone. Completo di 2 fori.</p> <p><b>Modello reversibile</b></p>	<p><b>60</b> cm base sottolavello</p> 
<p><b>BLANCO LEMIS 8-IF</b> Acciaio Inox 18/10</p>  <p><b>Accessori idonei:</b> 1 3 KIT COMANDO SALTARELLO INCLUSO</p>	<p><b>Incasso</b></p> <p><b>Dettagli Colore / Finitura</b></p> <p>Confezione in cartone</p> <p>Dimensioni intaglio per incasso sopra-top: 840x480 mm - R 15 Raggio interno: 60 mm Raggio fondo vasca: 30 mm Profondità vasche: 205/205 mm</p> <p><b>Fornitura:</b> vasche con piletta da 3½" e tappo a cestello, saltarello e sifone. Completo di 2 fori.</p> <p><b>Modello reversibile</b></p>	<p><b>80</b> cm base sottolavello</p> 
<p><b>BLANCO LEMIS 8 S-IF</b> Acciaio Inox 18/10</p>  <p><b>Accessori idonei:</b> 1 KIT COMANDO SALTARELLO INCLUSO</p>	<p><b>Incasso</b></p> <p><b>Dettagli Colore / Finitura</b></p> <p>Confezione in cartone</p> <p>Dimensioni intaglio per incasso sopra-top: 1140x480 mm - R 15 Raggio interno: 60 mm Raggio fondo vasca: 30 mm Profondità vasche: 205/205 mm</p> <p><b>Fornitura:</b> vasche con piletta da 3½", tappo a cestello, saltarello e sifone. Completo di 2 fori.</p> <p><b>Modello reversibile</b></p>	<p><b>80</b> cm base sottolavello</p> 

I lavelli contrassegnati con il simbolo  non possono essere montati a "inizio/fine composizione" nella base sottolavello indicata; possono essere invece facilmente inseriti in una base di misura superiore..

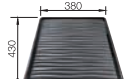
Accessori opzionali				
<p><b>Kit ganci per top di spessore da 15 a 30 mm (10 pz.)</b></p>  <p>Cod. 1223742 Euro 15,00</p>	<p><b>Copertura scarico CapFlow</b></p>  <p>Ø 114</p> <p>Cod. 1517666 Euro 39,00</p>	<p><b>Cestello inox con griglia per piatti</b></p>  <p>318 137 66</p> <p>Cod. 1507829 Euro 239,00</p>	<p><b>Vaschetta forata in acciaio inox</b></p>  <p>197 206</p> <p>Cod. 1240729 Euro 96,00</p>	<p><b>Gocciolatoio sintetico nero</b></p>  <p>380 430</p> <p>Cod. 1230734 Euro 85,00</p>

# BLANCO LANTOS-IF

Il design incontra la convenienza



Lavello: BLANCO LANTOS XL 6 S-IF Compact



BLANCO LANTOS 45 S-IF Compact



BLANCO LANTOS 45 S-IF Salto



BLANCO LANTOS XL 6 S-IF Compact



BLANCO LANTOS XL 6 S-IF



BLANCO LANTOS 6-IF



BLANCO LANTOS II 6 S-IF



BLANCO LANTOS 8-IF Compact



BLANCO LANTOS 8 S-IF

LAVELLI  
INOX



La famiglia BLANCO LANTOS-IF convince per le sue linee classiche e l'ottimo rapporto qualità-prezzo. Il **bordo perimetrale -IF** si integra in modo particolarmente elegante al piano di lavoro. Una delle novità della famiglia BLANCO LANTOS-IF sono le grandi vasche confortevoli, e spaziose, in grado di offrire un comfort unico per la preparazione dei cibi e il lavaggio delle stoviglie. I lavelli BLANCO LANTOS-IF sono adatti per tutti i piani di lavoro e basi sottolavello, sono tutti dotati del pratico tappo a cestello da 3½" e dell'elegante **saltarello girevole**.



Il bordo -IF della famiglia di lavelli BLANCO LANTOS-IF permette l'installazione sia a filotop, sia sopratop, ma con un look a semifilo.

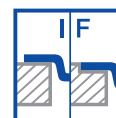

Tipologia di incasso:



La vaschetta forata in acciaio inox, disponibile come accessorio per BLANCO LANTOS II 6 S-IF, agevola il lavaggio e il risciacquo delle posate, utensili e alimenti.

#### Il bordo -IF di BLANCO LANTOS:

- Si inserisce perfettamente in ogni cucina
- Rende la pulizia del piano di lavoro più semplice, non avendo bordi sporgenti

Per saperne di più: [www.blanco.com/it](http://www.blanco.com/it)



**BLANCO LANTOS 45 S-IF Compact**  
Acciaio Inox 18/10



Accessori idonei:

1



Incasso

Dettagli  
Colore / Finitura

Codice

Euro



Sopratop  
e filotop

Confezione in cartone

1619059

272,00

Dimensioni intaglio per incasso sopratop: 756x476 mm - R 33  
Profondità vasca: 160 mm

**Fornitura:** vasca con piletta da 3½", sifone, tappo a cestello e saltarello. Completo di 2 fori.

**Modello reversibile**

**60** cm base  
sottolavello

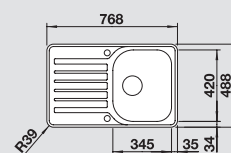

**BLANCO LANTOS 45 S-IF Salto**  
Acciaio Inox 18/10



Accessori idonei:

1



Incasso

Dettagli  
Colore / Finitura

Codice

Euro



Sopratop  
e filotop

Confezione in cartone

1619707

272,00

Dimensioni intaglio per incasso sopratop: 836x476 mm - R 15  
Profondità vasca: 160 mm

**Fornitura:** vasca con piletta da 3½", sifone, tappo a cestello e saltarello. Completo di 2 fori.

**Modello reversibile**

 **45** cm base  
sottolavello

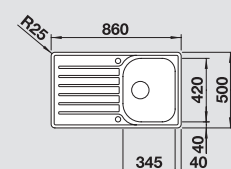

**BLANCO LANTOS XL 6 S-IF Compact**  
Acciaio Inox 18/10



Accessori idonei:

1



Incasso

Dettagli  
Colore / Finitura

Codice

Euro



Sopratop  
e filotop

Confezione in cartone

1623140

340,00

Dimensioni intaglio per incasso sopratop: 756x476 mm - R 15  
Profondità vasca: 160 mm

**Fornitura:** vasca con piletta da 3½", sifone, tappo a cestello e saltarello. Completo di 2 fori.

**Modello reversibile**

**60** cm base  
sottolavello

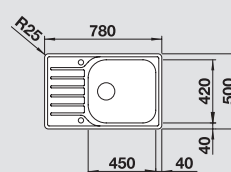

**BLANCO LANTOS XL 6 S-IF**  
Acciaio Inox 18/10



Accessori idonei:

1



Incasso

Dettagli  
Colore / Finitura

Codice

Euro



Sopratop  
e filotop

Confezione in cartone

1619709

363,00

Dimensioni intaglio per incasso sopratop: 976x476 mm - R 15  
Profondità vasca: 160 mm

**Fornitura:** vasca con piletta da 3½", sifone, tappo a cestello e saltarello. Completo di 2 fori.

**Modello reversibile**

 **60** cm base  
sottolavello

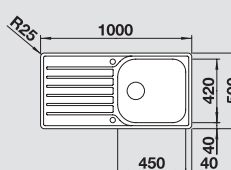

**BLANCO LANTOS 6-IF**  
Acciaio Inox 18/10



Accessori idonei:

1 2 3



Incasso

Dettagli  
Colore / Finitura

Codice

Euro



Sopratop  
e filotop

Confezione in cartone

1616676

386,00

Dimensioni intaglio per incasso sopratop: 581x476 mm - R 48  
Profondità vasche: 175/145 mm







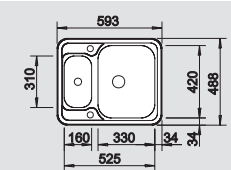



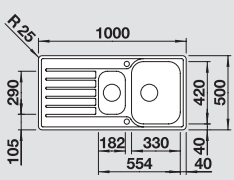

**Fornitura:** Vasche con piletta da 3½", tappo a cestello, sifone e saltarello (solo per la vasca principale). Completo di 2 fori.

**Modello reversibile**

 **60** cm base  
sottolavello

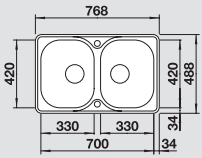



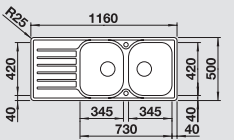



<b>BLANCO LANTOS 6 S-IF</b> <b>Acciaio Inox 18/10</b>  <b>Accessori idonei:</b> <div style="border: 1px solid black; padding: 2px; display: inline-block;">1   4</div> KIT COMANDO SALTARELLO <b>INCLUSO</b> 	<b>Incasso</b> <b>Dettagli</b> <b>Colore / Finitura</b>  <b>Sopratop e filtop</b> Confezione in cartone Profondità vasche: 170/90 mm Dimensioni intaglio per incasso sopratop: 976x476 mm - R 15 <b>Fornitura:</b> vasche con piletta da 3½", sifone, tappo a cestello e saltarello. Completo di 2 fori. <b>Modello reversibile</b>	<b>Codice</b> <b>Euro</b> 1619720    398,00	 <b>60</b> cm base sottolavello 
<b>BLANCO LANTOS 8-IF Compact</b> <b>Acciaio Inox 18/10</b>  <b>Accessori idonei:</b> <div style="border: 1px solid black; padding: 2px; display: inline-block;">1   2</div> KIT COMANDO SALTARELLO <b>INCLUSO</b> 	<b>Incasso</b> <b>Dettagli</b> <b>Colore / Finitura</b>  <b>Sopratop e filtop</b> Confezione in cartone Dimensioni intaglio per incasso sopratop: 756x476 mm - R 33 Profondità vasche: 165 mm <b>Fornitura:</b> vasche con piletta da 3½", sifone, tappo a cestello e saltarello per una vasca. Completo di 2 fori. <b>Modello reversibile</b>	<b>Codice</b> <b>Euro</b> 1620434    357,00	 <b>80</b> cm base sottolavello 
<b>BLANCO LANTOS 8 S-IF Compact</b> <b>Acciaio Inox 18/10</b>  <b>Accessori idonei:</b> <div style="border: 1px solid black; padding: 2px; display: inline-block;">1   2</div> KIT COMANDO SALTARELLO <b>INCLUSO</b> 	<b>Incasso</b> <b>Dettagli</b> <b>Colore / Finitura</b>  <b>Sopratop e filtop</b> Confezione in cartone Dimensioni intaglio per incasso sopratop: 1136x476 mm - R 15 Profondità vasche: 160 mm <b>Fornitura:</b> vasche con piletta da 3½", sifone, tappo a cestello e saltarello per una vasca. Completo di 2 fori. <b>Modello reversibile</b>	<b>Codice</b> <b>Euro</b> 1619713    398,00	<b>80</b> cm base sottolavello  

LAVELLI INOX

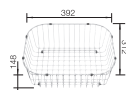
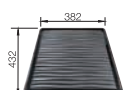
I lavelli contrassegnati con il simbolo  non possono essere montati a "inizio/fine composizione" nella base sottolavello indicata; possono essere invece facilmente inseriti in una base di misura superiore.

BLANCO UNIT con BLANCO LANTOS -IF		Accessori opzionali			
<b>Miscelatore</b> <b>BLANCO DARAS</b> 	<b>Raccolta differenziata</b> <b>BLANCO FLEXON II 60/3 Low</b>  <b>NUOVO</b>	<b>Cestello</b> <b>in acciaio inox</b> 	<b>Gocciolatoio</b> <b>sintetico nero</b> 	<b>Vaschetta forata</b> <b>in acciaio inox</b> 	<b>Vaschetta forata</b> <b>in acciaio inox</b> 
Cod. 1517720 Euro 111,00	Cod. 1526642 Euro 239,00	Cod. 1220573 Euro 136,00	Cod. 1230734 Euro 85,00	Cod. 1208195 Euro 147,00	Cod. 1207600 Euro 130,00
		1	2	3	4

# BLANCO TIPO

Una nuova definizione di praticità.



LAVELLI  
INOX

Lavello: BLANCO TIPO 45 S  
Miscelatore: BLANCO MILI



BLANCO TIPO 45



BLANCO TIPO 45 S Compact



BLANCO TIPO 45 S



BLANCO TIPO II 6 SB



BLANCO TIPO 8



BLANCO TIPO 8 S Compact



I lavelli della famiglia BLANCO TIPO si caratterizzano per le loro **vasche ampie** e il loro **design funzionale**.

Il bordo ribassato di tutti i modelli BLANCO TIPO agevola le operazioni di pulizia e ne aumenta la praticità; il foro di scarico da 3½" velocizza le operazioni di svuotamento della vasca, e si adatta a qualsiasi esigenza, come per esempio l'installazione di un dissipatore.

L'esperienza nella lavorazione dell'acciaio inox 18/10 e l'alta tecnologia impiegata nella produzione, permettono a BLANCO di proporre per i propri lavelli un materiale di altissima qualità.



La vaschetta forata inox, disponibile come accessorio per il mod. BLANCO TIPO 6 S, agevola le operazioni quotidiane in cucina e aumenta comfort e praticità.



Tipologia di incasso:

#### GANCI PREMONTATI



I ganci premontati, presenti di serie su tutti i lavelli BLANCO TIPO, permettono un montaggio più veloce, sicuro e sempre a regola d'arte.

#### GUARNIZIONE TERMO SALDATA



La guarnizione termosaldata, presente di serie su tutti i modelli BLANCO TIPO, garantisce un'installazione sicura e maggiore protezione contro eventuali infiltrazioni d'acqua.

**BLANCO TIPO 45**  
Acciaio Inox 18/10



**Accessori idonei**



GANCI  
PREMONTATI

GUARNIZIONE  
TERMO SALDATA

**Incasso**

**Dettagli**  
Colore / Finitura

**Codice**

**Euro**



Sopratop  
bordo 4 mm

Confezione in cartone

1619425

207,00

Dimensioni intaglio: 462x482 mm - R 15  
Profondità vasca: 175 mm

**Fornitura:** vasca con piletta da 3½" e tappo a cestello

**Specificare all'ordine la posizione del foro per il miscelatore, considerando la posizione dello scarico e del troppopieno; se non specificato, la vasca verrà fornita senza foro miscelatore.**

**60** cm base  
sottolavello

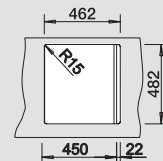
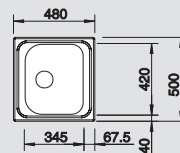

**BLANCO TIPO 45 S Compact**  
Acciaio Inox 18/10



**Accessori idonei**



GANCI  
PREMONTATI

GUARNIZIONE  
TERMO SALDATA

**Incasso**

**Dettagli**  
Colore / Finitura

**Codice**

**Euro**



Sopratop  
bordo 4 mm

Vasca DX - Confezione in cartone

1318615

244,00

Vasca SX - Confezione in cartone

1318616

244,00

Dimensioni intaglio: 762x482 mm - R 15  
Profondità vasca: 170 mm

**Fornitura:** vasca con piletta da 3½" e tappo a cestello

**60** cm base  
sottolavello

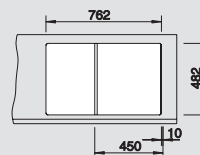
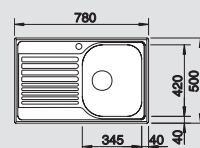

**BLANCO TIPO 45 S**  
Acciaio Inox 18/10



**Accessori idonei**



GANCI  
PREMONTATI

GUARNIZIONE  
TERMO SALDATA

**Incasso**

**Dettagli**  
Colore / Finitura

**Codice**

**Euro**



Sopratop  
bordo 4 mm

Vasca DX - Confezione in cartone

1324947

244,00

Vasca SX - Confezione in cartone

1324948

244,00

Dimensioni intaglio: 842x482 mm - R 15  
Profondità vasca: 170 mm

**Fornitura:** vasca con piletta da 3½" e tappo a cestello

**45** cm base  
sottolavello

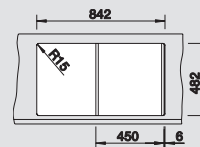
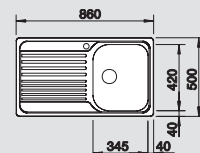

**BLANCO UNIT con BLANCO TIPO**

**Miscelatore**  
BLANCO DARAS-S



Cod. 1517731  
Euro 193,00

**Raccolta differenziata**  
BLANCO SINGOLO XL



Cod. 1526377  
Euro 181,00

**NUOVO**

**Dissipatore BLANCO**  
FWD Lite



Cod. 1526646  
Euro 681,00

**NUOVO**

**Accessori opzionali**

**Copertura scarico**  
CapFlow



Cod. 1517666  
Euro 39,00



BLANCO TIPO II 6 S Acciaio Inox 18/10	Incasso	Dettagli Colore / Finitura	Codice	Euro
--	---------	-------------------------------	--------	------

 **60** cm base  
sottolavello



Sopratop  
bordo 4 mm

Vasca DX - Confezione in cartone	1316495	335,00
Vasca SX - Confezione in cartone	1316496	335,00

Dimensioni intaglio: 982x482 mm - R 15  
Profondità vasche: 90/170 mm

**Fornitura:** vasche con piletta da 3½" e tappo a cestello

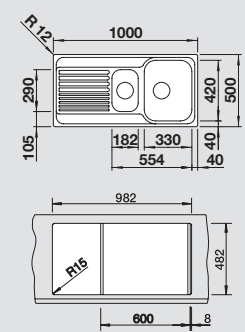

#### Accessori idonei



GANCI  
PREMONTATI

GUARNIZIONE  
TERMO SALDATA

BLANCO TIPO 8 Acciaio Inox 18/10	Incasso	Dettagli Colore / Finitura	Codice	Euro
-------------------------------------	---------	-------------------------------	--------	------

 **80** cm base  
sottolavello



Sopratop  
bordo 4 mm

Confezione in cartone	1324949	301,00
-----------------------	---------	--------

Dimensioni intaglio: 842x482 mm - R 15  
Profondità vasche: 170 mm

**Fornitura:** vasche con piletta da 3½" e tappo a cestello

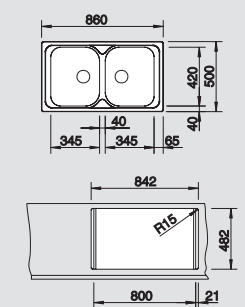

#### Accessori idonei



GANCI  
PREMONTATI

GUARNIZIONE  
TERMO SALDATA

BLANCO TIPO 8 S Compact Acciaio Inox 18/10	Incasso	Dettagli Colore / Finitura	Codice	Euro
---	---------	-------------------------------	--------	------

**80** cm base  
sottolavello



Sopratop  
bordo 4 mm

Vasca DX - Confezione in cartone	1324950	335,00
Vasca SX - Confezione in cartone	1324951	335,00

Dimensioni intaglio: 1140x480 mm - R 15  
Profondità vasche: 170/170 mm

**Fornitura:** vasche con piletta da 3½" e tappo a cestello

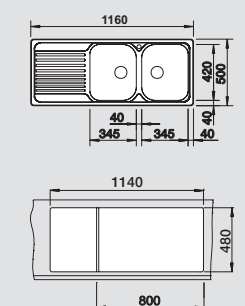

#### Accessori idonei



GANCI  
PREMONTATI

GUARNIZIONE  
TERMO SALDATA

I lavelli contrassegnati con il simbolo  non possono essere montati a "inizio/fine composizione" nella base sottolavello indicata; possono essere invece facilmente inseriti in una base di misura superiore.

#### Accessori opzionali

Kit ganci per top di spessore  
da 15 a 30 mm (10 pz.)



Cod. 1223742  
Euro 15,00

Cestello  
in acciaio inox



Cod. 1514238  
Euro 130,00

Tagliere a ponte  
in legno massello



Cod. 1218313  
Euro 136,00

Tagliere a ponte  
in materiale sintetico



Cod. 1217611  
Euro 142,00

Vaschetta forata  
in acciaio inox



Cod. 1240729  
Euro 96,00

Cestello  
in acciaio inox

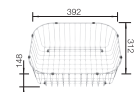

Cod. 1220573  
Euro 136,00

# BLANCO DINAS

Solidità e affidabilità



Lavello: BLANCO DINAS XL 6 S Advanced  
Miscelatore: BLANCO MIDA-S

BLANCO DINAS, la famiglia di lavelli in acciaio inox che si distingue per il suo connubio di qualità e convenienza, arricchisce la propria gamma coi modelli versione Advanced.

La guarnizione termosaldata è di serie su tutti i lavelli BLANCO DINAS.

GUARNIZIONE  
TERMO SALDATA



Nella versione Advanced il saltarello è incluso nella fornitura.



La guarnizione termosaldata è di serie.

Tipologia  
di incasso



BLANCO DINAS 45 S Acciaio Inox 18/10	Incasto	Dettagli Colore / Finitura	Codice	Euro
---	---------	-------------------------------	--------	------

 **45** cm base  
sottolavello



Sopratop  
bordo 4 mm

Vasca DX - Confezione in cartone	1328102	284,00
Vasca SX - Confezione in cartone	1328103	284,00

Dimensioni intaglio per incasso sopratop: 840x480 mm - R 15  
Profondità vasca: 190 mm

**Fornitura:** vasca con piletta da 3½", tappo a cestello

Accessori idonei:

1 2 3

GUARNIZIONE  
TERMO SALDATA



Sopratop  
bordo 4 mm

#### BLANCO DINAS 45-S Advanced

Confezione in cartone	1623378	315,00
-----------------------	---------	--------

Dimensioni intaglio per incasso sopratop: 840x480 mm - R 15  
Profondità vasca: 190 mm

**Fornitura:** vasca con piletta da 3½", tappo a cestello e saltarello.  
Completo di 2 fori.

**Modello reversibile**

Accessori idonei:

1 2 3

GUARNIZIONE  
TERMO SALDATA

KIT COMANDO  
SALTARELLO  
INCLUSO

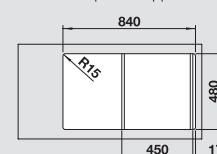
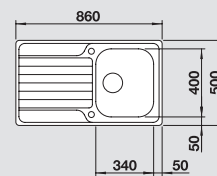
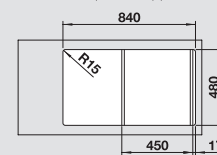
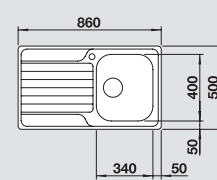

BLANCO DINAS XL 6 S Acciaio Inox 18/10	Incasto	Dettagli Colore / Finitura	Codice	Euro
---	---------	-------------------------------	--------	------

 **60** cm base  
sottolavello



Sopratop  
bordo 4 mm

Vasca DX - Confezione in cartone	1336786	398,00
Vasca SX - Confezione in cartone	1336785	398,00

Dimensioni intaglio per incasso sopratop: 980x480 mm - R 15  
Profondità vasca: 190 mm

**Fornitura:** vasca con piletta da 3½", tappo a cestello

Accessori idonei:

1 2

GUARNIZIONE  
TERMO SALDATA



Sopratop  
bordo 4 mm

#### BLANCO DINAS XL 6 S Advanced

Confezione in cartone	1336788	428,00
-----------------------	---------	--------

Dimensioni intaglio per incasso sopratop: 980x480 mm - R 15  
Profondità vasca: 190 mm

**Fornitura:** vasca con piletta da 3½", tappo a cestello e saltarello.  
Completo di 2 fori.

**Modello reversibile**

Accessori idonei:

1 2

GUARNIZIONE  
TERMO SALDATA

KIT COMANDO  
SALTARELLO  
INCLUSO

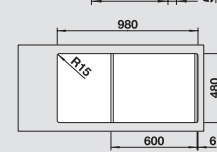
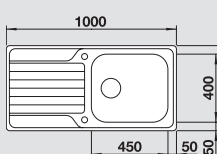
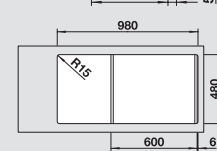
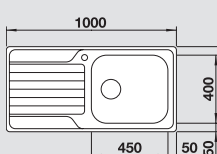

LAVELLI  
INOX

I lavelli contrassegnati con il simbolo  non possono essere montati a "inizio/fine composizione" nella base sottolavello indicata; possono essere invece facilmente inseriti in una base di misura superiore.

### BLANCO UNIT con BLANCO DINAS

### Accessori opzionali

Miscelatore  
BLANCO MIDA-S



Cod. 1521454  
Euro 379,00

BLANCO BOTTON Pro  
45/2 Manuale



Cod. 1517467  
Euro 210,00

Copertura scarico  
CapFlow



Cod. 1517666  
Euro 39,00

Vaschetta forata  
in acciaio inox



Cod. 1227689  
Euro 147,00

Tagliere a ponte  
in legno massello

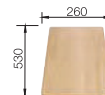

Cod. 1218313  
Euro 136,00

Tagliere a ponte  
in materiale sintetico



Cod. 1217611  
Euro 142,00

**BLANCO DINAS 6 S**  
Acciaio Inox 18/10



**Accessori idonei:**



GUARNIZIONE  
**TERMO SALDATA**

**Incasso**

**Dettagli**  
Colore / Finitura

**Codice**

**Euro**



Sopratop  
bordo 4 mm

Vasca DX - Confezione in cartone  
Vasca SX - Confezione in cartone

1328104 414,00  
1328105 414,00

Dimensioni intaglio per incasso sopratop: 980x480 mm - R 15  
Profondità vasche: 140/190 mm

**Fornitura:** vasche con piletta da 3½", tappo a cestello

**60** cm base  
sottolavello

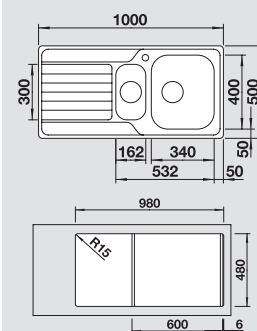

**Accessori idonei:**



GUARNIZIONE  
**TERMO SALDATA**

KIT COMANDO  
SALTARELLO  
**INCLUSO**



Sopratop  
bordo 4 mm

**BLANCO DINAS 6 S Advanced**

Confezione in cartone

1623379 446,00

Dimensioni intaglio per incasso sopratop: 980x480 mm - R 15  
Profondità vasche: 140/190 mm

**Fornitura:** vasche con piletta da 3½", tappo a cestello e saltarello.  
Completo di 2 fori.

**Modello reversibile**

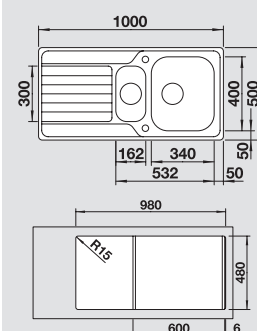

**BLANCO DINAS 8**  
Acciaio Inox 18/10



**Accessori idonei:**



GUARNIZIONE  
**TERMO SALDATA**

**Incasso**

**Dettagli**  
Colore / Finitura

**Codice**

**Euro**



Sopratop  
bordo 4 mm

Confezione in cartone

1328108 374,00

Dimensioni intaglio per incasso sopratop: 840x480 mm - R 15  
Profondità vasche: 190 mm

**Fornitura:** vasche con piletta da 3½", tappo a cestello

**80** cm base  
sottolavello

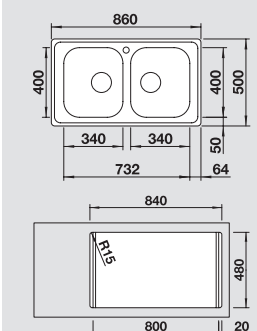

**Accessori idonei:**



GUARNIZIONE  
**TERMO SALDATA**

KIT COMANDO  
SALTARELLO  
**INCLUSO**



Sopratop  
bordo 4 mm

**BLANCO DINAS 8 Advanced**

Confezione in cartone

1624116 406,00

Dimensioni intaglio per incasso sopratop: 840x480 mm - R 15  
Profondità vasche: 190 mm

**Fornitura:** vasche con piletta da 3½", tappo a cestello e saltarello.  
Completo di 2 fori.

**Modello reversibile**

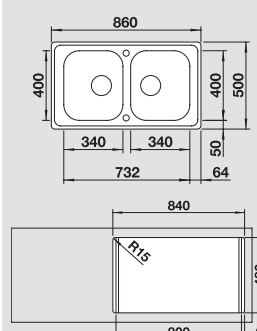



BLANCO DINAS 8 S Acciaio Inox 18/10	Incasso	Dettagli Colore / Finitura	Codice	Euro
--	---------	-------------------------------	--------	------

**80** cm base  
sottolavello



Sopratop  
bordo 4 mm

Vasca DX - Confezione in cartone	1328106	414,00
Vasca SX - Confezione in cartone	1328107	414,00

Dimensioni intaglio per incasso sopratop: 1140x480 mm - R 15  
Profondità vasche: 190 mm

**Fornitura:** vasche con pileta da 3½", tappo a cestello

Accessori idonei:



GUARNIZIONE  
TERMO SALDATA



Sopratop  
bordo 4 mm

#### BLANCO DINAS 8 S Advanced

Confezione in cartone	1624115	446,00
-----------------------	---------	--------

Dimensioni intaglio per incasso sopratop: 1140x480 mm - R 15  
Profondità vasche: 190 mm

**Fornitura:** vasche con pileta da 3½", tappo a cestello e saltarello.  
Completo di 2 fori.

**Modello reversibile**

Accessori idonei:

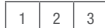

GUARNIZIONE  
TERMO SALDATA

KIT COMANDO  
SALTARELLO  
INCLUSO

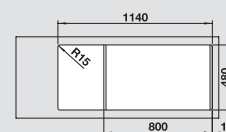
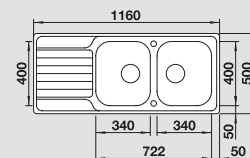
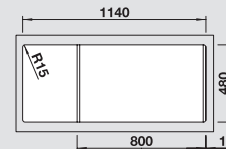
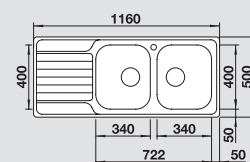

Lavello: BLANCO DINAS 8 S  
Miscelatore: BLANCO MILA-S

LAVELLI  
INOX

I lavelli contrassegnati con il simbolo  non possono essere montati a "inizio/fine composizione" nella base sottolavello indicata; possono essere invece facilmente inseriti in una base di misura superiore.

#### BLANCO UNIT con BLANCO DINAS

#### Accessori opzionali

Miscelatore  
BLANCO MIDA-S



Cod. 1521454  
Euro 379,00

BLANCO BOTTON Pro  
45/2 Manuale



Cod. 1517467  
Euro 210,00

Copertura scarico  
CapFlow



Cod. 1517666  
Euro 39,00

Vaschetta forata  
in acciaio inox



Cod. 1227689  
Euro 147,00

Tagliere a ponte  
in legno massello

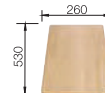

Cod. 1218313  
Euro 136,00

Tagliere a ponte  
in materiale sintetico



Cod. 1217611  
Euro 142,00





# BLANCODANA 45

Acciaio Inox 18/10

## Vasca straordinariamente ampia

- Ampia e funzionale fascia posteriore a fianco del miscelatore
- Ampio raggio della vasca per offrire maggiore comfort in tutte le attività quotidiane

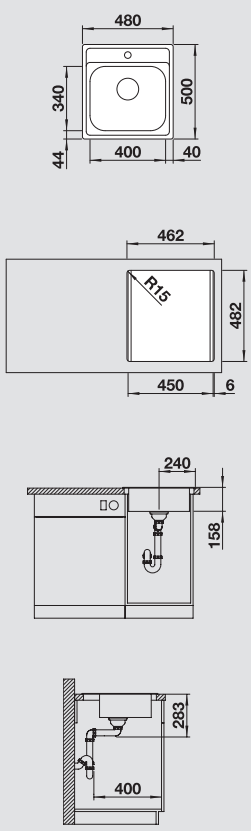
BLANCODANA 45 Acciaio Inox 18/10	Incasso	Dettagli Colore / Finitura	Codice	Euro	45 cm base sottolavello
	 Sopratop	Confezione in cartone	1625322	420,00	
Dimensioni intaglio per incasso sopratop: 462x482 mm - R 15 Profondità vasca: 158 mm		<b>Fornitura:</b> vasca con piletta da 3½" e tappo a cestello			

LAVELLI  
INOX

Per installazione su top di altezza inferiore ai 30 mm e fino a 15 mm di spessore, usare set ganci cod. 1223742 (v. pag. 258)

### BLANCO UNIT con BLANCO DANA 45

### Accessori opzionali

Miscelatore  
BLANCO DARAS



Cod. 1517720  
Euro 111,00

BLANCO BOTTON Pro 45/2  
Automatica



Cod. 1517468  
Euro 255,00

Dissipatore BLANCO  
FWD Lite



Cod. 1526646  
Euro 681,00

NUOVO

Copertura scarico  
CapFlow



Cod. 1517666  
Euro 39,00

Tagliere a ponte  
in legno massello

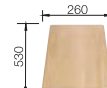

Cod. 1218313  
Euro 136,00

Tagliere a ponte  
in materiale sintetico



Cod. 1217611  
Euro 142,00

# BLANCODANA 6

Acciaio Inox 18/10

## Vasca straordinariamente ampia

- Ampia e funzionale fascia posteriore a fianco del miscelatore
- Ampio raggio della vasca per offrire più comfort anche nelle operazioni di pulizia



**BLANCODANA 6**  
Acciaio Inox 18/10

**Incasso**

**Dettagli**  
Colore / Finitura

**Codice**

**Euro**

**60** cm base  
sottolavello



Sopratop

Confezione in cartone

1625323

465,00

Dimensioni intaglio per incasso sopratop: 587x482 mm - R 15  
Profondità vasca: 158 mm

**Fornitura:** vasca con piletta da 3½" e tappo a cestello

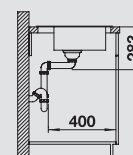
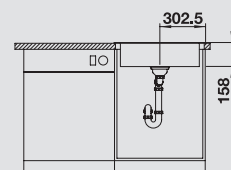
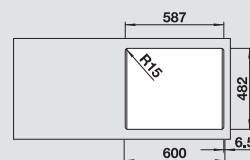
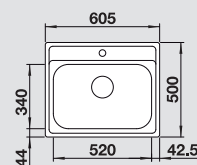

LAVELLI  
INOX

Per installazione su top di altezza inferiore ai 30 mm e fino a 15 mm di spessore, usare set ganci cod. 1223742 (v. pag. 258)

## BLANCO UNIT con BLANCO DANA 6

## Accessori opzionali

Miscelatore  
BLANCO MIDA-S



Cod. 1521454  
Euro 379,00

BLANCO BOTTON Pro 60/3  
Automatica



Cod. 1517469  
Euro 266,00

Dissipatore BLANCO  
FWD Lite



Cod. 1526646  
Euro 681,00

NUOVO

Copertura scarico  
CapFlow



Cod. 1517666  
Euro 39,00

Tagliere a ponte  
in legno massello

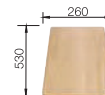

Cod. 1218313  
Euro 137,00

Tagliere a ponte  
in materiale sintetico



Cod. 1217611  
Euro 142,00





# BLANCO PLENTA

Acciaio Inox 18/10

## Capacità e flessibilità in formato XXL

- Massimo volume disponibile nella vasca grande e capiente
- Numerosi e pratici accessori disponibili a richiesta
- Versione sopratop dotata di ampia fascia, molto funzionale a fianco del miscelatore, ove poter installare il dispenser di sapone o gli utensili di uso quotidiano

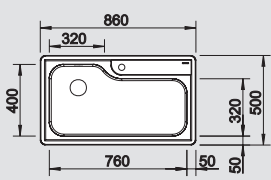
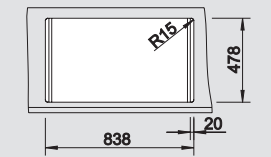
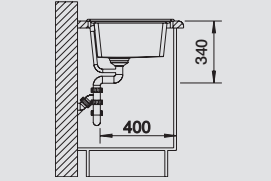
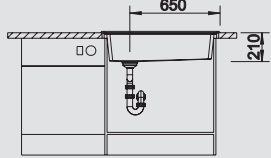
BLANCO PLENTA Acciaio Inox 18/10	Incasso	Dettagli Colore / Finitura	Codice	Euro	90 cm base sottolavello
	 Sopratop	Confezione in cartone	1614029	624,00	   
		Dimensioni intaglio per incasso: 838x478 mm - R 15 Profondità vasca: 210 mm			
<b>Fornitura:</b> vasca con piletta da 3½" e tappo a cestello					

Per installazione su top di altezza inferiore ai 30 mm e fino a 15 mm di spessore, usare set ganci cod. 1223742 (v. pag. 258)

### BLANCO UNIT con BLANCO PLENTA

Miscelatore  
BLANCOCULINA-S Mini



Cod. 1519843  
Euro 868,00

BLANCO BOTTON Pro  
45/2 Automatica



Cod. 1517468  
Euro 255,00

Dissipatore BLANCO  
FWD Lite



Cod. 1526646  
Euro 681,00

**NUOVO**

Copertura scarico  
CapFlow



Cod. 1517666  
Euro 39,00

Tagliere  
in legno massello

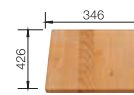

Cod. 1219891  
Euro 147,00

Griglia per piatti  
in acciaio inox

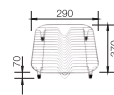

Cod. 1220381  
Euro 136,00





# BLANCO RONDOSOL BLANCO RONDOSOL-IF

Acciaio Inox 18/10

Il lavello per "ambienti" minimalisti

- Ampia vasca
- Cestello per piatti e tagliere in legno massello disponibili come pratici accessori a richiesta

BLANCO RONDOSOL Acciaio Inox 18/10	Incasso	Dettagli Colore / Finitura	Codice	Euro	 <b>45</b> cm base sottolavello
---------------------------------------	---------	-------------------------------	--------	------	---



Sopratop

Confezione in cartone

1613306

239,00

Dimensioni intaglio per incasso: 444 mm di diametro  
Profondità vasca: 175 mm

**Fornitura:** vasca con piletta da 3½" e tappo a cestello

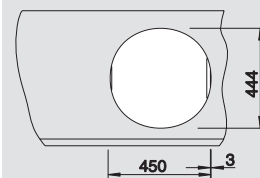
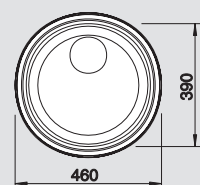

BLANCO RONDOSOL-IF Acciaio Inox 18/10	Incasso	Dettagli Colore / Finitura	Codice	Euro	 <b>45</b> cm base sottolavello
--	---------	-------------------------------	--------	------	---



Sopratop  
e filotop

Confezione in cartone

1614647

261,00

Dimensioni intaglio per incasso sopratop: 434 mm di diametro  
Profondità vasca: 175 mm

**Fornitura:** vasca con piletta da 3½" e tappo a cestello

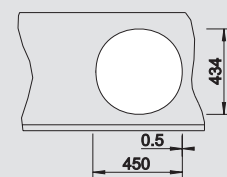
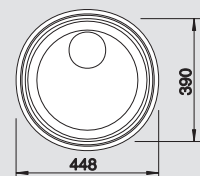

I lavelli contrassegnati con il simbolo  non possono essere montati a "inizio/fine composizione" nella base sottolavello indicata; possono essere invece facilmente inseriti in una base di misura superiore.

Per installazione su top di altezza inferiore ai 30 mm e fino a 15 mm di spessore, usare set ganci cod. 1223742 (v. pag. 258)

## BLANCO UNIT con BLANCO RONDOSOL, -IF

## Accessori opzionali

Miscelatore  
BLANCO MIDA-S



Cod. 1521454  
Euro 379,00

BLANCO BOTTON Pro  
45/2 Automatica



Cod. 1517468  
Euro 255,00

Dissipatore BLANCO  
FWD Lite



Cod. 1526646  
Euro 681,00

**NUOVO**

Copertura scarico  
CapFlow



Cod. 1517666  
Euro 39,00

Tagliere  
in legno massello



Cod. 1218421  
Euro 147,00

Cestello  
in acciaio inox



Cod. 1220574  
Euro 113,00

# ESTETICA E FUNZIONALITÀ IN TUTTE LE LORO SFACCETTATURE.

Miscelatori da cucina BLANCO.



In BLANCO puntiamo all'eccellenza, in particolare quando si tratta di sistemi coordinati di miscelatori, lavelli e sistemi per la raccolta differenziata. Per un'area del lavello senza soluzione di continuità in cucina, sia in termini di funzione ed estetica, che di installazione e manutenzione. BLANCO offre un'ampia gamma di miscelatori, per un'infinita varietà di esigenze e stili dell'ambiente cucina. La qualità eccellente, l'estetica accattivante, la tecnologia all'avanguardia e la semplicità d'uso abbinate a un'ampia scelta di dimensioni e colori rendono facile trovare il miscelatore giusto per le proprie esigenze.



BLANCO è pienamente consapevole della propria responsabilità per la fonte di vita più preziosa: l'acqua potabile. I miscelatori BLANCO sono ampiamente testati per tecnologia e igiene, offrendo uno dei più alti standard di qualità. Tutti i componenti a contatto con l'acqua sono testati e certificati.



Tutti i componenti sono realizzati utilizzando le più recenti tecnologie e con materiali di altissima qualità, fornendo così la massima sicurezza in termini di salute e igiene. La durata e l'affidabilità dei componenti sono al centro della progettazione del nostro prodotto.

# QUALITÀ FIN NEL MINIMO DETTAGLIO.

Miscelatori da cucina BLANCO.

I miscelatori da cucina BLANCO sono all'avanguardia della tecnologia e sono soggetti ai più severi controlli di qualità. Per ogni necessità, il team di assistenza BLANCO è a tua completa disposizione.

Numerosi modelli di miscelatori come BLANCO LINUS, LINUS-S, CANDOR o BLANCO CULINA-S Mini possono essere facilmente aggiornati con il set aeratore, che include un rompigitto per flusso trasparente e un rompigitto per flusso aerato. Verificare la compatibilità con il servizio clienti prima di acquistare il set aeratore BLANCO.

Una rapida occhiata  
al flusso di erogazione dell'acqua

## Erogazione limpida Erogazione aerata

- |                   |           |
|-------------------|-----------|
| • trasparente     | • aerato  |
| • silenzioso      | • morbido |
| • nessuno schizzo | • potente |

**Set aeratore**  
con rompigitto trasparente  
e rompigitto aerato

Cod. 1521746  
Euro 50,00



## Installazione sicura e manutenzione perfetta

- Si consiglia di far installare il miscelatore da un professionista autorizzato.
- Non pulire le superfici del miscelatore da cucina con detersivi caustici o abrasivi. Si consiglia di utilizzare BLANCO DailyClean+, cod. 1526305.
- Se il flusso d'acqua si indebolisce, risciacquare il rompigitto.

Per proteggere il miscelatore da sporco e danneggiamenti (perdite, flusso d'acqua ridotto), è indispensabile installare un filtro a maglia metallica (incluso di serie) tra il rubinetto di arresto e il flessibile.



Filtro a maglia metallica

Cod. 1128434  
Euro 46,00



DailyClean+

Cod. 1526305  
Euro 34,00

# MODALITÀ DEL FLUSSO D'ACQUA BLANCO.

Flusso limpido contro flusso aerato.



Il getto d'acqua potente e aerato è lo standard per la maggior parte dei miscelatori. Il flusso d'acqua limpido e originale, noto anche con il termine tecnico "laminare", è chiamato da BLANCO "flusso limpido".

Questo termine è usato per evidenziare la caratteristica del flusso d'acqua: limpidezza, purezza e delicatezza. Laddove il flusso aerato è noto per la sua dinamica, il flusso d'acqua limpido convince per la sua forma naturale e la silenziosità.

La bassa turbolenza riduce al minimo gli schizzi e la nebulizzazione dell'acqua. Il risultato: meno macchie d'acqua, meno strofinamenti, più purezza nel miscelatore e nel lavello.

A differenza del flusso limpido, lineare e silenzioso, il flusso d'acqua aerato vorticoso facilita la pulizia, grazie all'aria miscelata al suo interno.

## Offerta e aggiornamento

Attualmente, le famiglie PANERA-S e AVONA vengono fornite con flusso limpido. Numerosi miscelatori come BLANCO LINUS, LINUS-S, BLANCO CANDOR o BLANCO CUCILINA-S Mini possono essere facilmente aggiornati con il set aeratore, che include un rompigitto per flusso limpido e uno per flusso aerato (cod. 1521746). Si prega di verificare la compatibilità con il servizio clienti prima di acquistare il set aeratore BLANCO.

Una rapida occhiata al flusso di erogazione dell'acqua

### Erogazione limpida Erogazione aerata

- |                   |           |
|-------------------|-----------|
| • trasparente     | • aerato  |
| • silenzioso      | • morbido |
| • nessuno schizzo | • potente |

**Set aeratore**  
con rompigitto trasparente  
e rompigitto aerato



Cod. 1521746  
Euro 50,00



# BLANCO drink.filter EVOL-S Pro

**NUOVO**

- Miscelatore semi-professionale 3-in-1: eroga acqua fredda, calda e filtrata
- Click & Touch: la quantità desiderata di acqua filtrata viene impostata tramite la manopola graduata con controllo touch
- Filtro multistrato BWT di ultima generazione
- Due erogazioni separate per l'acqua filtrata e l'acqua dell'impianto di casa
- Doccetta con supporto magnetico



Sistema:

- Filtro BWT di ultima generazione, incl. testata e cartuccia multistrato
- Control box con display integrato che mostra la rimanente capacità del filtro



Miscelatore:

- Girevole fino a 360° per acqua calda e fredda
- Girevole fino a 180° per l'acqua filtrata
- Diametro foro per miscelatore: Ø 35 mm
- Dotato di cartuccia in ceramica
- Flessibili in dotazione per un'installazione semplice e veloce
- Rompigetto brevettato per una marcata riduzione dei depositi di calcare
- Contropiastra di rinforzo per una maggiore stabilità

# BLANCO drink.filter EVOL-S Pro

**NUOVO**

- Miscelatore semi-professionale 3-in-1: eroga acqua fredda, calda e filtrata
- Click & Touch: la quantità desiderata di acqua filtrata viene impostata tramite la manopola graduata con controllo touch
- Filtro multistrato BWT
- Due erogazioni separate per l'acqua filtrata e l'acqua dell'impianto di casa
- Doccetta con supporto magnetico



Sistema:

- Filtro BWT di ultima generazione, incl. testata e cartuccia multistrato
- Control box con display integrato che mostra la rimanente capacità del filtro



Miscelatore:

- Girevole fino a 360° per acqua calda e fredda
- Girevole fino a 180° per l'acqua filtrata
- Diametro foro per miscelatore: Ø 35 mm
- Dotato di cartuccia in ceramica
- Flessibili in dotazione per un'installazione semplice e veloce
- Rompigetto brevettato per una marcata riduzione dei depositi di calcare
- Contropiastra di rinforzo per una maggiore stabilità



Dettagli Colore / Finitura	Codice	Euro
Finitura PVD Steel	1526311	2.779,00

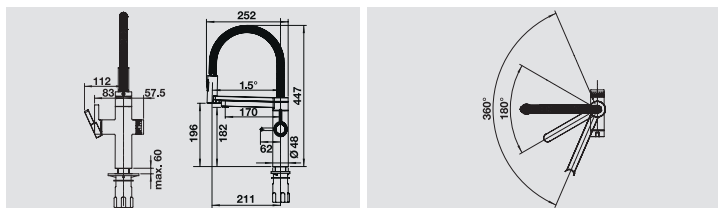

Dettagli Colore / Finitura	Codice	Euro
Nero Opaco	1526636	3.062,00

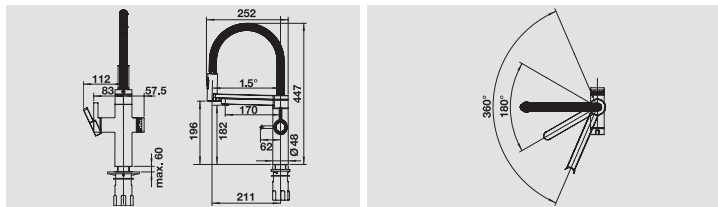

## BLANCO drink.filter EVOL-S Pro

### Accessori

Dispenser di sapone  
BLANCO LATO



Cod. 1525789  
Euro 176,00

Raccolta differenziata  
BLANCO SELECT II 60/2



Cod. 1526203  
Euro 522,00

Filtro a cartuccia



COMPRESO

Controllerbox



COMPRESO

Testata di fissaggio



COMPRESO

Ricambio  
filtro a cartuccia



Cod. 1525273  
Euro 363,00



## BLANCO SOLENTA-S Senso Leva Sinistra

- Erogazione dell'acqua in modalità manuale o start-stop tramite sensore di movimento
- **Leva comando a sinistra per un abbinamento perfetto per lavelli con vasca a destra**
- Variazione del getto: da flusso normale a doccia
- Doccetta con fissaggio magnetico al supporto
- Disponibile anche in finitura PVD Steel



Dettagli Colore / Finitura	Codice	Euro
Cromato - Leva SX	1523126	1.962,00
Finitura PVD Steel - Leva SX	1523127	2.212,00



**Consigliato:** versione con leva sinistra per lavelli con vasca a destra del miscelatore.



**Sconsigliato:** versione con leva sinistra per lavelli con vasca a sinistra del miscelatore. Può causare l'attivazione involontaria.

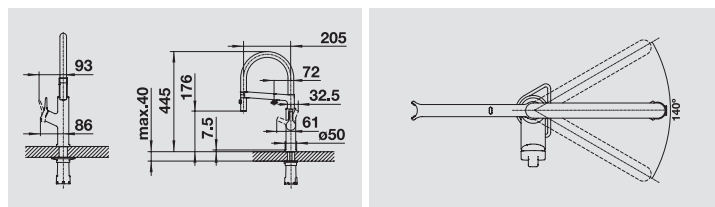

- Escursione della leva comando: 61 mm in avanti e 32,5 mm indietro rispetto alla mezzeria della canna
- Predisposto per collegamento a 230V
- Girevole sino a 140°
- Diametro foro per miscelatore: 35 mm
- Dotato di cartuccia in ceramica
- Flessibili da 450 mm con dado da 3/8" per una facile installazione
- Rompigetto brevettato per una marcata riduzione dei depositi di calcare
- Contropiastra di rinforzo per una maggiore stabilità
- Dotato di valvola di non-ritorno certificata EN 1717
- Certificato LGA e DVGW



## BLANCO SOLENTA-S Senso Leva Destra

- Erogazione dell'acqua in modalità manuale o start-stop tramite sensore di movimento
- **Leva comando a sinistra per un abbinamento perfetto per lavelli con vasca a sinistra**
- Variazione del getto: da flusso normale a doccia
- Doccetta con fissaggio magnetico al supporto
- Disponibile anche in finitura PVD Steel



Dettagli Colore / Finitura	Codice	Euro
Cromato - Leva DX	1522406	1.962,00
Finitura PVD Steel - Leva DX	1522407	2.212,00



**Consigliato:** versione con leva destra per lavelli con vasca a sinistra del miscelatore.



**Sconsigliato:** versione con leva destra per lavelli con vasca a destra del miscelatore. Può causare l'attivazione involontaria.

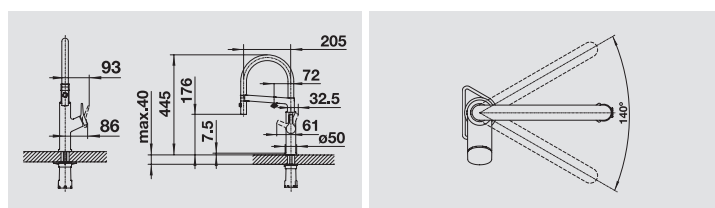

- Escursione della leva comando: 61 mm in avanti e 32,5 mm indietro rispetto alla mezzeria della canna
- Predisposto per collegamento a 230V
- Girevole sino a 140°
- Diametro foro per miscelatore: 35 mm
- Dotato di cartuccia in ceramica
- Flessibili da 450 mm con dado da 3/8" per una facile installazione
- Rompigetto brevettato per una marcata riduzione dei depositi di calcare
- Contropiastra di rinforzo per una maggiore stabilità
- Dotato di valvola di non-ritorno certificata EN 1717
- Certificato LGA e DVGW



## BLANCO SOLENTA-S

- Miscelatore semi-professionale con leva laterale
- Doccetta in finitura inox, magnetica e con variatore di getto
- La leva comandi ruota solo in avanti (max 90°) per agevolare il posizionamento del miscelatore anche a ridosso di pareti posteriori
- Disponibile anche nella finitura PVD Steel, adatta a vasche e lavelli in acciaio inox



Dettagli Colore / Finitura	Codice	Euro
Cromato	1522404	1.180,00
Finitura PVD Steel	1522405	1.532,00



Impostazione di partenza della leva di comando a freddo

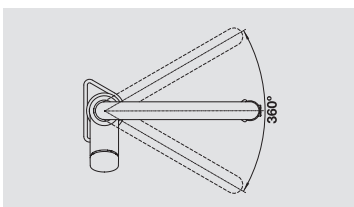
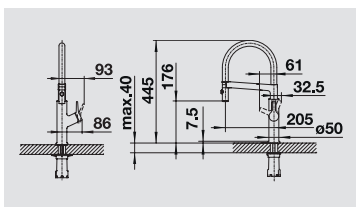

- Escursione della leva comando: 61 mm in avanti e 32,5 mm indietro rispetto alla mezzeria della canna
- Girevole sino a 360°
- Diametro foro per miscelatore: 35 mm
- Dotato di cartuccia in ceramica
- Flessibili da 450 mm con dado da 3/8" per una facile installazione
- Rompigetto brevettato per una marcata riduzione dei depositi di calcare
- Contropiastra di rinforzo per una maggiore stabilità
- Dotato di valvola di non-ritorno certificata EN 1717
- Certificato LGA e DVGW



## BLANCO PANERA-S

- Accurato nella lavorazione ed esclusivo design
- La doccetta estraibile offre la massima maneggevolezza
- Commutazione da getto fisso a doccia con la semplice pressione di un tasto
- Adatto per installazione a ridosso della parete superiore



Dettagli Colore / Finitura	Codice	Euro
Acciaio massiccio spazzolato	1521547	1.832,00



Impostazione di partenza della leva di comando a freddo

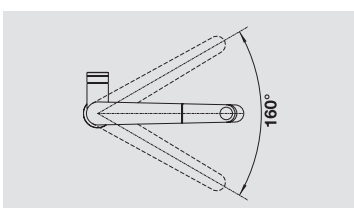
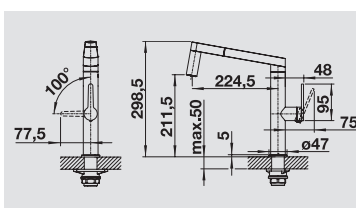

- Escursione della leva comandi: 77,5 mm in avanti rispetto la mezzeria della canna
- Girevole sino a 160°
- Diametro foro per miscelatore: 35 mm
- Dotato di cartuccia in ceramica
- Flessibili da 560 mm con dado da 3/8" per una facile installazione
- Rompigetto brevettato per una marcata riduzione dei depositi di calcare
- Contropiastra di rinforzo per una maggiore stabilità
- Dotato di valvola di non-ritorno certificata EN 1717
- Certificato LGA e DVGW



## BLANCOCULINA-S Duo

- Miscelatore dal design esclusivo
- Perfetto abbinamento con le vasche inox senza fascia miscelatore
- Leva comandi separata
- Doccetta in metallo di alta qualità con fissaggio magnetico alla canna



Dettagli Colore / Finitura	Codice	Euro
Cromato	1519782	1.259,00

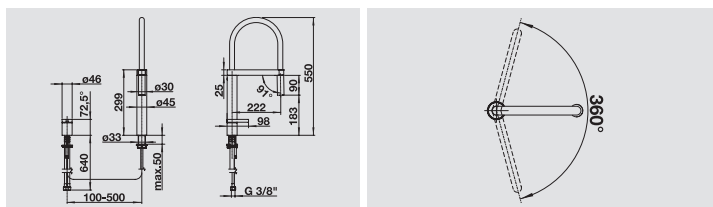

- Girevole sino a 360°
- Diametro foro per miscelatore e leva comandi: 35 mm
- Dotato di cartuccia in ceramica
- Flessibili da 640 mm con dado da 3/8" per una facile installazione
- Contropiastra di rinforzo per una maggiore stabilità
- Dotato di valvola di non-ritorno certificata EN 1717
- Certificato LGA e DVGW



## BLANCOCULINA-S Duo

- Miscelatore dal design esclusivo
- Perfetto abbinamento con le vasche inox senza fascia miscelatore
- Leva comandi separata posizionabile liberamente sul piano di lavoro
- Adatto per installazione a ridosso della parete posteriore
- Doccetta con fissaggio magnetico alla canna



Dettagli Colore / Finitura	Codice	Euro
Acciaio Massiccio Satinato Opaco	1519784	1.985,00

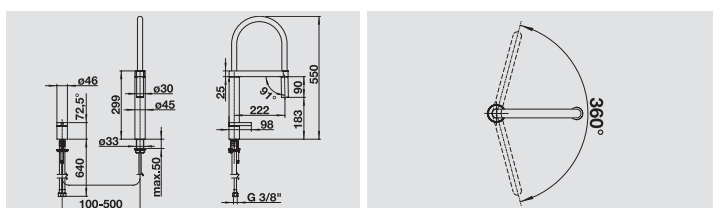

- Girevole sino a 360°
- Diametro foro per miscelatore e leva comandi: 35 mm
- Dotato di cartuccia in ceramica
- Flessibili da 640 mm con dado da 3/8" per una facile installazione
- Contropiastra di rinforzo per una maggiore stabilità
- Dotato di valvola di non-ritorno certificata EN 1717
- Certificato LGA e DVGW





## BLANCO CULINA-S

- La molla in acciaio inox consente libertà di movimento fino alla vasca
- Fissaggio magnetico della doccetta al corpo del miscelatore
- Selettore del flusso da getto a doccia con sistema anticalcare
- Adatto per installazione a ridosso della parete posteriore



Dettagli Colore / Finitura	Codice	Euro
Cromato	1517597	1.180,00
Effetto Inox	1517598	1.542,00



Impostazione di partenza della leva di comando a freddo

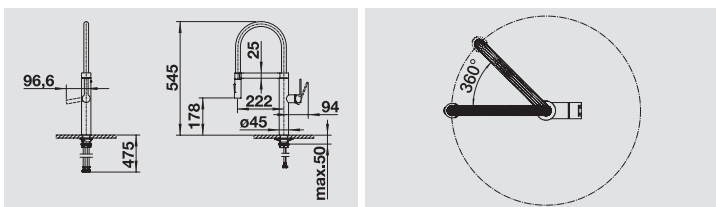

- Escursione della leva comando: 96,6 mm in avanti rispetto alla mezzeria della canna
- Girevole sino a 360°
- Diametro foro per miscelatore: 35 mm
- Dotato di cartuccia in ceramica
- Flessibili da 450 mm con dado da 3/8" per una facile installazione
- Contropiastra di rinforzo per una maggiore stabilità
- Dotato di valvola di non-ritorno certificata EN 1717
- Certificato LGA e DVGW



## BLANCO CULINA-S Mini

- Massima libertà di movimento fino all'area della vasca grazie alla molla in acciaio inox
- Doccetta in metallo di alta qualità con fissaggio magnetico alla canna
- Adatto per installazione a ridosso della parete posteriore



Dettagli Colore / Finitura	Codice	Euro
Cromato	1519843	868,00
Effetto Inox	1519844	1.055,00



Impostazione di partenza della leva di comando a freddo

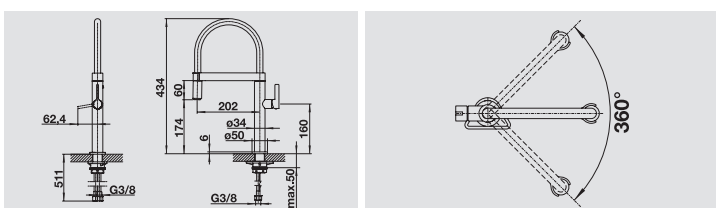

- Escursione della leva comando: 62,4 mm in avanti rispetto rispetto alla mezzeria della canna
- Girevole sino a 360°
- Diametro foro per miscelatore: 35 mm
- Dotato di cartuccia in ceramica
- Flessibili da 450 mm con dado da 3/8" per una facile installazione
- Contropiastra di rinforzo per una maggiore stabilità
- Dotato di doccetta con valvola di non ritorno EN 1717
- Rompigetto brevettato per una marcata riduzione dei depositi di calcare
- Certificato LGA e DVGW



## BLANCO LINEE

- Design esclusivo
- Leva comandi in posizione superiore per una migliore accessibilità
- A canna alta per agevolare il riempimento di vasi o contenitori particolarmente ingombranti



Dettagli Colore / Finitura	Codice	Euro
Cromato	1517594	635,00

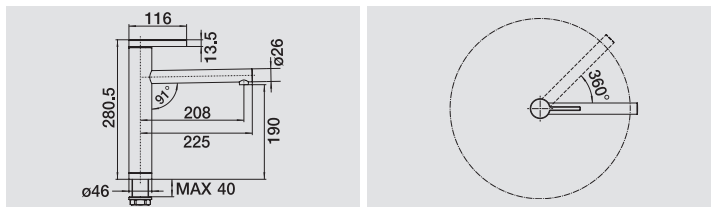

- Girevole sino a 360°
- Diametro foro per miscelatore: 35 mm
- Dotato di cartuccia in ceramica
- Flessibili da 450 mm con dado da 3/8" per una facile installazione
- Contropiastra di rinforzo per una maggiore stabilità
- Rompigetto brevettato per una marcata riduzione dei depositi di calcare
- Certificato LGA e DVGW



## BLANCO LINEE-S

- Design esclusivo
- Leva comandi in posizione superiore per una migliore accessibilità
- A canna alta per agevolare il riempimento di vasi o contenitori particolarmente ingombranti
- Dotato di doccetta estraibile in metallo di alta qualità



Dettagli Colore / Finitura	Codice	Euro
Cromato	1517591	772,00

Dettagli Colore / Finitura	Codice	Euro
Nero/Cromato	1526171	1.248,00
Antracite/Cromato	1518438	1.248,00
Grigio Roccia/Cromato	1518804	1.248,00
Alumetallic/Cromato	1518439	1.248,00
Grigio Vulcano/Cromato	1526956	1.248,00
Bianco/Cromato	1518441	1.248,00
Soft White/Cromato	1526957	1.248,00
Tartufo/Cromato	1518446	1.248,00
Caffè/Cromato	1518445	1.248,00

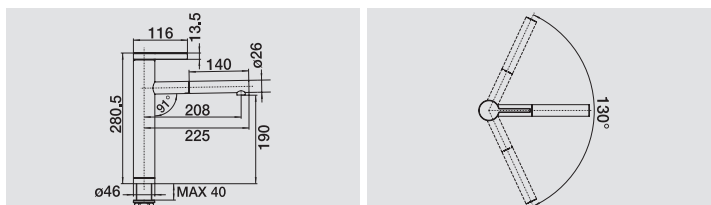

- Girevole sino a 170°
- Diametro foro per miscelatore: 35 mm
- Dotato di cartuccia in ceramica
- Flessibili da 450 mm con dado da 3/8" per una facile installazione
- Contropiastra di rinforzo per una maggiore stabilità
- Dotato di valvola di non-ritorno certificata EN 1717
- Rompigetto brevettato per una marcata riduzione dei depositi di calcare
- Certificato LGA e DVGW



## BLANCO LINEE

- Design esclusivo
- In acciaio massiccio di alta qualità
- Leva comandi in posizione superiore per una migliore accessibilità
- A canna alta per agevolare il riempimento di vasi o contenitori particolarmente ingombranti



Dettagli Colore / Finitura	Codice	Euro
Acciaio Massiccio Satinato Opaco	1517596	1.265,00

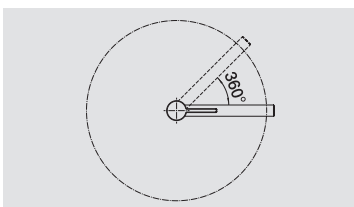
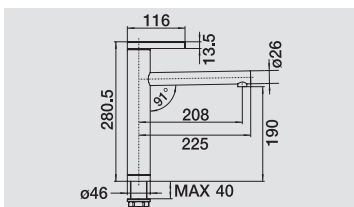

- Girevole sino a 360°
- Diametro foro per miscelatore: 35 mm
- Dotato di cartuccia in ceramica
- Flessibili da 450 mm con dado da 3/8" per una facile installazione
- Contropiastra di rinforzo per una maggiore stabilità
- Rompigetto brevettato per una marcata riduzione dei depositi di calcare
- Certificato LGA e DVGW



## BLANCO LINEE-S

- Design esclusivo
- In acciaio massiccio di alta qualità
- Leva comandi in posizione superiore per una migliore accessibilità
- A canna alta per agevolare il riempimento di vasi o contenitori particolarmente ingombranti
- Dotato di doccetta estraibile in metallo



Dettagli Colore / Finitura	Codice	Euro
Acciaio Massiccio Satinato Opaco	1517593	1.400,00

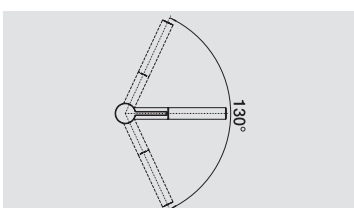
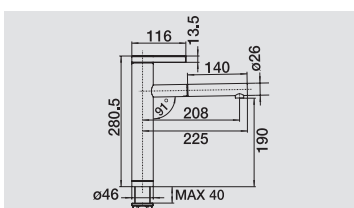

- Girevole sino a 130°
- Diametro foro per miscelatore: 35 mm
- Dotato di cartuccia in ceramica
- Flessibili da 450 mm con dado da 3/8" per una facile installazione
- Contropiastra di rinforzo per una maggiore stabilità
- Dotato di valvola di non-ritorno certificata EN 1717
- Rompigetto brevettato per una marcata riduzione dei depositi di calcare
- Certificato LGA e DVGW





## BLANCO VONDA

- Leva comandi ergonomica in posizione frontale con superficie in soft/grip
- Miscelatore a canna alta, per agevolare il riempimento di vasi e contenitori voluminosi
- Perfetto abbinamento con vasche sottotop



Dettagli Colore / Finitura	Codice	Euro
Acciaio Massiccio Spazzolato	1518435	652,00

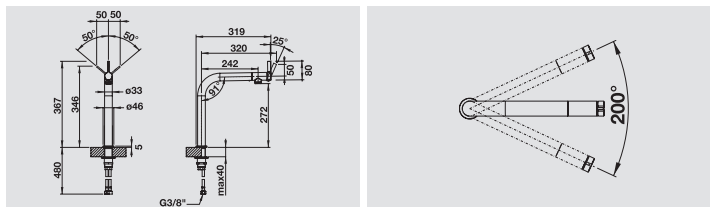

- Girevole sino a 200°
- Diametro foro per miscelatore: 35 mm
- Dotato di cartuccia in ceramica
- Flessibili da 450 mm con dado da 3/8" per una facile installazione
- Contropiastra di rinforzo per una maggiore stabilità
- Rompigetto brevettato per una marcata riduzione dei depositi di calcare
- Certificato LGA e DVGW



## BLANCO VONDA

- Leva comandi ergonomica in posizione frontale con superficie in soft/grip
- Miscelatore a canna alta, per agevolare il riempimento di vasi e contenitori voluminosi
- Perfetto abbinamento con vasche sottotop
- Adatto per installazione a ridosso della parete posteriore



Dettagli Colore / Finitura	Codice	Euro
Cromato	1518434	947,00

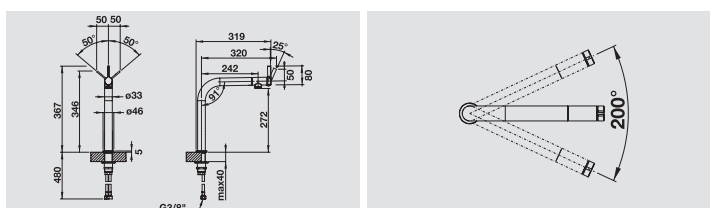

- Girevole sino a 200°
- Diametro foro per miscelatore: 35 mm
- Dotato di cartuccia in ceramica
- Flessibili da 450 mm con dado da 3/8" per una facile installazione
- Contropiastra di rinforzo per una maggiore stabilità
- Rompigetto brevettato per una marcata riduzione dei depositi di calcare
- Certificato LGA e DVGW





## BLANCO LIVIA-S

- Dotato di doccetta estraibile
- Soluzione abbinabile con comando a saltarello e dispenser di sapone della stessa linea e disponibili in diverse finiture (v. pag. 244)
- Progettato per vasche sottotop e piani di lavoro di alta qualità



Dettagli Colore / Finitura	Codice	Euro
Cromato	1521288	868,00
Ottone Satinato	1521289	1.491,00
Grigio Manganese	1521290	



Impostazione di partenza della leva di comando a freddo

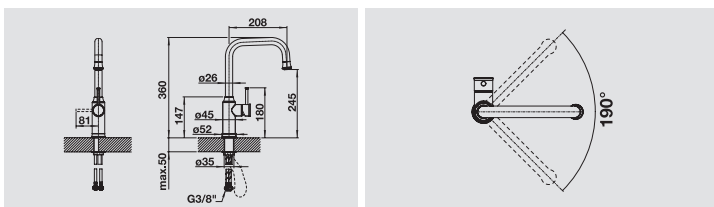

- Escursione della leva comando: 81 mm in avanti rispetto alla mezzeria della canna
- Girevole sino a 190°
- Diametro foro per miscelatore: 35 mm
- Dotato di cartuccia in ceramica
- Flessibili da 450 mm con dado da 3/8" per una facile installazione
- Rompigetto brevettato per una marcata riduzione dei depositi di calcare
- Contropiastra di rinforzo per una maggiore stabilità
- Dotato di valvola di non-ritorno certificata EN 1717
- Certificato LGA e DVGW



## BLANCO LIVIA-S **NUOVO** Satin Gold

- Dotato di doccetta estraibile
- Finitura Satin Gold, per un'assoluta eleganza
- Soluzione abbinabile con comando a saltarello e dispenser di sapone della stessa linea e disponibili in diverse finiture (v. pag. 244)
- Progettato per vasche sottotop e piani di lavoro di alta qualità



Dettagli Colore / Finitura	Codice	Euro
PVD Satin Gold	1576687	999,00



Impostazione di partenza della leva di comando a freddo

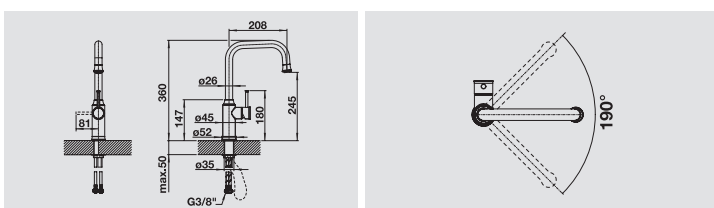

- Escursione della leva comando: 81 mm in avanti rispetto alla mezzeria della canna
- Girevole sino a 190°
- Diametro foro per miscelatore: 35 mm
- Dotato di cartuccia in ceramica
- Flessibili da 450 mm con dado da 3/8" per una facile installazione
- Rompigetto brevettato per una marcata riduzione dei depositi di calcare
- Contropiastra di rinforzo per una maggiore stabilità
- Dotato di valvola di non-ritorno certificata EN 1717
- Certificato LGA e DVGW

# BLANCO SONEA-S Flexo **NUOVO**



- Design con dettagli in nero per le cucine più moderne
- Acciaio massiccio di alta qualità con superficie spazzolata
- Canna flessibile in gomma nera con ampio raggio di movimento
- Doccetta flessibile in gomma nera con variatore di getto e fissaggio magnetico alla canna



Dettagli Colore / Finitura	Codice	Euro
Acciaio Massiccio Spazzolato	1526616	606,00



Impostazione di partenza della leva di comando a freddo

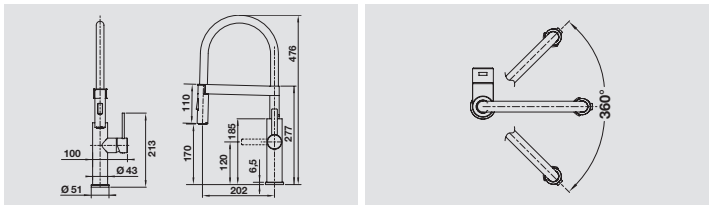

- Girevole sino a 360°
- Diametro foro per miscelatore: 35 mm
- Dotato di cartuccia in ceramica
- Doccetta in materiale sintetico
- Flessibili da 700 mm con dado da 3/8" per una facile installazione
- Rompigetto brevettato per una marcata riduzione dei depositi di calcare
- Contropiastra di rinforzo per una maggiore stabilità
- Dotato di valvola di non-ritorno certificata EN 1717
- Certificato LGA



MISCELATORI



## BLANCO AVONA

- Intrigante mix tra tondo e rettangolare
- Corpo affusolato con canna leggermente inclinata
- Adatto per installazione a ridosso della parete posteriore



Dettagli Colore / Finitura	Codice	Euro
Cromato	1521267	669,00



Impostazione di partenza della leva di comando a freddo

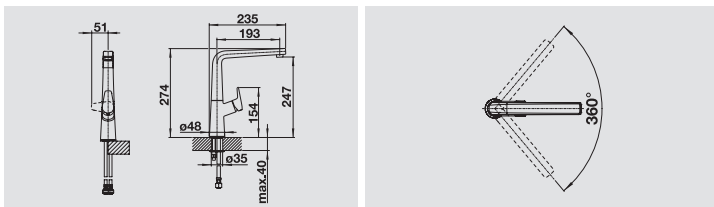

- Escursione della leva comando: 51 mm in avanti rispetto alla mezzeria della canna
- Girevole sino a 360°
- Diametro foro per miscelatore: 35 mm
- Dotato di cartuccia in ceramica
- Flessibili da 450 mm con dado da 3/8" per una facile installazione
- Rompigetto brevettato per una marcata riduzione dei depositi di calcare
- Contropiastra di rinforzo per una maggiore stabilità
- Certificato LGA



## BLANCO AVONA-S

- Intrigante mix tra tondo e rettangolare
- Corpo affusolato con canna leggermente inclinata
- Adatto per installazione a ridosso della parete posteriore
- Dotato di doccetta estraibile in metallo di alta qualità



**NUOVO**



Dettagli Colore / Finitura	Codice	Euro
Cromato	1521277	789,00



Impostazione di partenza della leva di comando a freddo

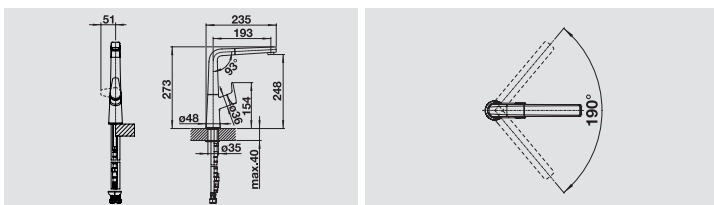

Dettagli Colore / Finitura	Codice	Euro
-------------------------------	--------	------

Nero	1526170	953,00
Antracite	1521278	953,00
Grigio Roccia	1521285	953,00
Alumetallic	1521279	953,00
Grigio Vulcano <b>NUOVO</b>	1526928	953,00
Bianco	1521280	953,00
Soft White <b>NUOVO</b>	1526929	953,00
Tartufo	1521283	953,00
Caffè	1521284	953,00

- Escursione della leva comando: 51 mm in avanti rispetto alla mezzeria della canna
- Girevole sino a 190°
- Diametro foro per miscelatore: 35 mm
- Dotato di cartuccia in ceramica
- Flessibili da 450 mm con dado da 3/8" per una facile installazione
- Rompigetto brevettato per una marcata riduzione dei depositi di calcare
- Contropiastra di rinforzo per una maggiore stabilità
- Dotato di valvola di non-ritorno certificata EN 1717
- Certificato LGA





## BLANCO ALTA Compact

- Progettato e sviluppato per i lavelli con dimensioni più ridotte
- Disponibile anche nella versione SILGRANIT® per una perfetta armonia con i lavelli dello stesso materiale



Dettagli Colore / Finitura	Codice	Euro
-------------------------------	--------	------

Cromato	1515120	601,00
---------	---------	--------

Dettagli Colore / Finitura	Codice	Euro
-------------------------------	--------	------

Nero	1526162	748,00
Antracite/Cromato	1515323	748,00
Grigio Roccia/Cromato	1518810	748,00
Alumetallic/Cromato	1515316	748,00
Bianco/Cromato	1515317	748,00
Tartufo/Cromato	1517633	748,00
Caffè/Cromato	1515324	748,00

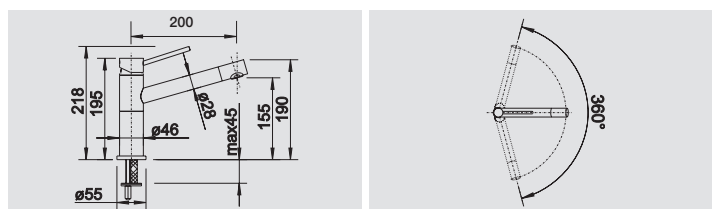

- Girevole sino a 360°
- Diametro foro per miscelatore: 35 mm
- Dotato di cartuccia in ceramica
- Flessibili da 450 mm con dado da 3/8" per una facile installazione
- Rompigetto brevettato per una marcata riduzione dei depositi di calcare
- Contropiastra di rinforzo per una maggiore stabilità
- Certificato LGA e DVGW



## BLANCO ALTA-S Compact

- Ideale per lavelli con dimensioni ridotte
- Dotato di doccetta estraibile in metallo
- Disponibile anche nella versione Silgranit



Dettagli Colore / Finitura	Codice	Euro
-------------------------------	--------	------

Cromato	1515122	811,00
---------	---------	--------

Dettagli Colore / Finitura	Codice	Euro
-------------------------------	--------	------

Nero/Cromato	1526161	999,00
Antracite/Cromato	1515333	999,00
Grigio Roccia/Cromato	1518809	999,00
Alumetallic/Cromato	1515326	999,00
Bianco/Cromato	1515327	999,00
Tartufo/Cromato	1517634	999,00
Caffè/Cromato	1515334	999,00

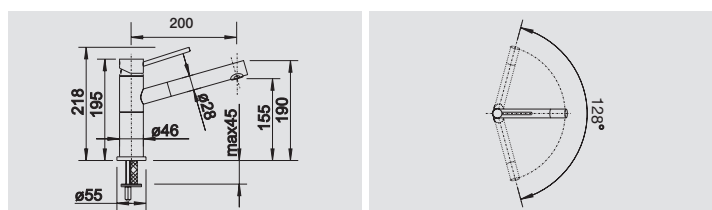

- Girevole sino a 128°
- Diametro foro per miscelatore: 35 mm
- Dotato di cartuccia in ceramica
- Flessibili da 450 mm con dado da 3/8" per una facile installazione
- Rompigetto brevettato per una marcata riduzione dei depositi di calcare
- Contropiastra di rinforzo per una maggiore stabilità
- Dotato di valvola di non-ritorno certificata EN 1717
- Certificato LGA e DVGW





## BLANCO CATRIS-S Flexo

- Linee classiche combinate con design semi-professionale e sofisticato
- Tubo flessibile in gomma nera
- Variazione del getto
- Bloccaggio della doccetta con supporto magnetico
- Disponibile nella finitura PVD Steel e in Nero Opaco (v.pag. successiva)



Dettagli Colore / Finitura	Codice	Euro
Cromato	1525791	697,00
Finitura PVD Steel	1525792	902,00

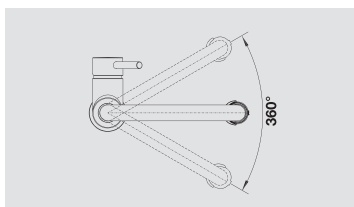
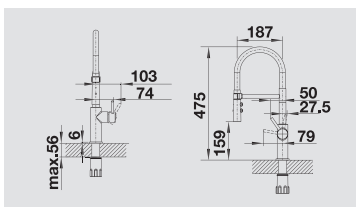

- Escursione della leva comando: 79 mm in avanti e 27,5 mm indietro rispetto alla mezzeria della canna
- Girevole sino a 360°
- Diametro foro per miscelatore: 35 mm
- Dotato di cartuccia in ceramica
- Tubo flessibile in gomma
- Flessibili da 450 mm con dado da 3/8" per una facile installazione
- Rompigetto brevettato per una marcata riduzione dei depositi di calcare
- Contropiastra di rinforzo per una maggiore stabilità
- Dotato di valvola di non-ritorno certificata EN 1717



## BLANCO CATRIS-S

- Design classico nella versione Semi-Profi
- Doccetta flessibile (con molla in acciaio inox) con finale rimovibile
- Variazione del getto



Dettagli Colore / Finitura	Codice	Euro
Cromato	1521476	652,00

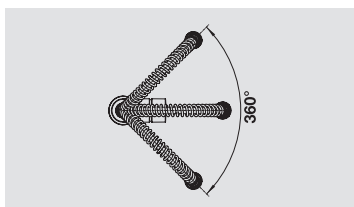
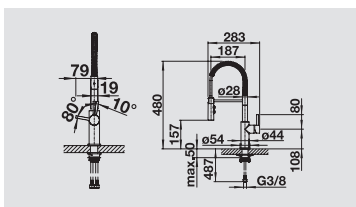

- Escursione della leva comando: 79 mm in avanti e 19 mm indietro rispetto alla mezzeria della canna
- Girevole sino a 360°
- Diametro foro per miscelatore: 35 mm
- Doccetta in materiale sintetico cromato
- Dotato di cartuccia in ceramica
- Flessibili da 450 mm con dado da 3/8" per una facile installazione
- Rompigetto brevettato per una marcata riduzione dei depositi di calcare
- Contropiastra di rinforzo per una maggiore stabilità
- Dotato di valvola di non-ritorno certificata EN 1717



## BLANCO CATRIS-S Flexo Nero Opaco

- Linee classiche combinate con design semi-professionale e sofisticato tubo flessibile in gomma nera
- Variazione del getto
- Bloccaggio della doccetta con supporto magnetico
- Esclusiva finitura Nero Opaco abbinabile con dispenser BLANCO LATO e comando saltarello della medesima finitura
- Perfetto abbinamento con vasche di colore Nero o Total Black



Dettagli Colore / Finitura	Codice	Euro
Nero Opaco	1525793	782,00

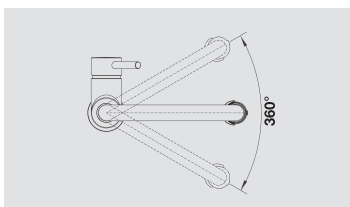
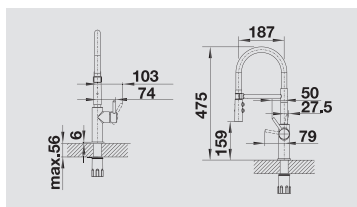

- Escursione della leva comando: 74 mm in avanti e 27,5 mm indietro rispetto alla mezzeria della canna
- Girevole sino a 360°
- Diametro foro per miscelatore: 35 mm
- Dotato di cartuccia in ceramica
- Tubo flessibile in gomma
- Flessibili da 450 mm con dado da 3/8" per una facile installazione
- Rompigetto brevettato per una marcata riduzione dei depositi di calcare
- Contropiastra di rinforzo per una maggiore stabilità
- Dotato di valvola di non-ritorno certificata EN 1717





# BLANCO FONTAS II NUOVO

## Nero Opaco

- Miscelatore a 3 vie
- Comandi ed erogatori separati per l'acqua della normale rete idrica e per l'acqua proveniente dal vostro impianto di filtraggio
- Finitura della superficie in Nero Opaco
- Disponibile kit di upgrade alla versione filtro



Impostazione di partenza della leva di comando a freddo



Dettagli Colore / Finitura	Codice	Euro
Nero Opaco	1526670	658,00

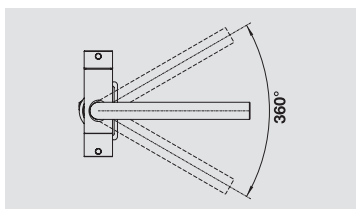
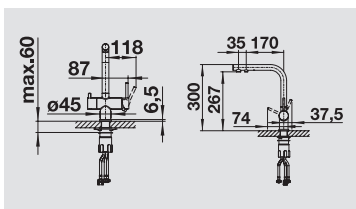

- Escursione della leva comando: 74 mm in avanti e 37,5 mm indietro rispetto alla mezzeria della canna
- Girevole sino a 360°
- Diametro foro per miscelatore: 35 mm
- Dotato di cartuccia in ceramica
- Filtri di depurazione non in dotazione
- Flessibili da 450 mm con dado da 3/8" per una facile installazione
- Rompigetto brevettato per una marcata riduzione dei depositi di calcare
- Contropiastra di rinforzo per una maggiore stabilità
- Certificato LGA

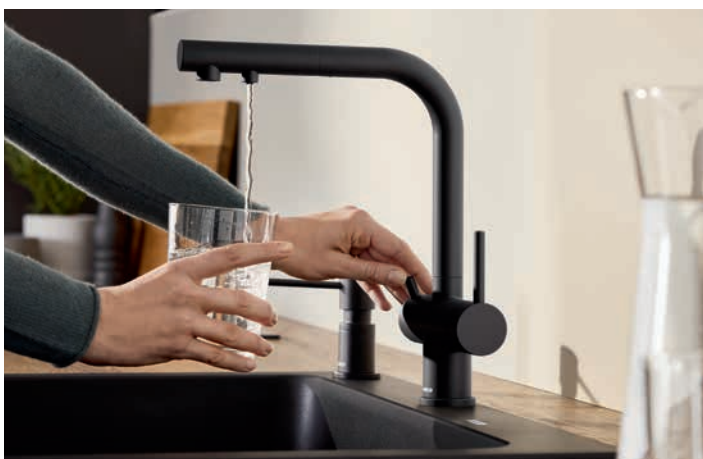

# BLANCO FONTAS-S II NUOVO

## Nero Opaco

- Miscelatore a 3 vie
- Comandi ed erogatori separati per l'acqua della normale rete idrica e per l'acqua proveniente dal vostro impianto di filtraggio
- Con doccetta estraibile
- Disponibile kit di upgrade alla versione filtro



Impostazione di partenza della leva di comando a freddo



Dettagli Colore / Finitura	Codice	Euro
Nero Opaco	1526672	924,00

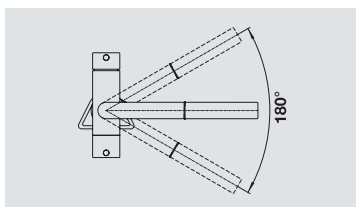
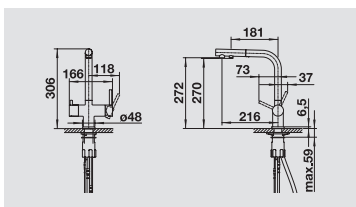

- Escursione della leva comando: 73 mm in avanti e 37 mm indietro rispetto alla mezzeria della canna
- Girevole sino a 180°
- Diametro foro per miscelatore: 35 mm
- Dotato di cartuccia in ceramica
- Filtri di depurazione non in dotazione
- Flessibili da 450 mm con dado da 3/8" per una facile installazione
- Rompigetto brevettato per una marcata riduzione dei depositi di calcare
- Dotato di valvola di non-ritorno certificata EN 1717
- Contropiastra di rinforzo per una maggiore stabilità

### Accessori

**Set di upgrade alla versione FILTRO**  
(composto da filtro BWT, testata di fissaggio, flussimetro, connettore a T e flessibile da 60 cm.)

**Filtro BWT, testata di fissaggio e flussimetro**



Cod. 1527453  
Euro 750,00

**Connettore a T**



COMPRESO NEL SET

**Flessibile da 60 cm**



COMPRESO NEL SET

**Ricambio filtro a cartuccia**



Cod. 1525273  
Euro 363,00





## BLANCO FONTAS II

- Miscelatore a 3 vie
- Comandi ed erogatori separati per l'acqua della normale rete idrica e per l'acqua proveniente dal vostro impianto di filtraggio
- Disponibile kit di upgrade alla versione filtro
- Disponibile nel colore Nero Opaco (v. pag. 197) e Satin Gold (v. pag. 200)



Erogazione di acqua filtrata



Erogazione di acqua potabile



Dettagli Colore / Finitura	Codice	Euro
Cromato	1523128	635,00
Finitura PVD Steel <b>NUOVO</b>	1523129	714,00

Dettagli Colore / Finitura	Codice	Euro
Nero	1526157	692,00
Antracite	1523130	692,00
Grigio Roccia	1523137	692,00
Alumetallic	1523131	692,00
Grigio Vulcano <b>NUOVO</b>	1526942	692,00
Bianco	1523134	692,00
Soft White <b>NUOVO</b>	1526943	692,00
Tartufo	1523136	692,00
Caffè	1523135	692,00



Impostazione di partenza della leva di comando a freddo

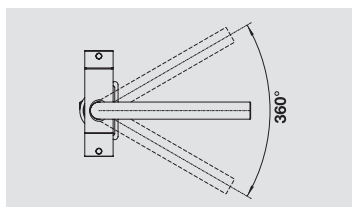
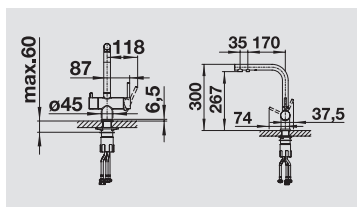

- Escursione della leva comando: 74 mm in avanti e 37,5 mm indietro rispetto alla mezzeria della canna
- Girevole sino a 360°
- Diametro foro per miscelatore: 35 mm
- Dotato di cartuccia in ceramica
- Filtri di depurazione non in dotazione
- Flessibili da 450 mm con dado da 3/8" per una facile installazione
- Rompigetto brevettato per una marcata riduzione dei depositi di calcare
- Contropiastra di rinforzo per una maggiore stabilità
- Certificato LGA



### Accessori

Set di upgrade alla versione **FILTRO** (composto da filtro BWT, testata di fissaggio, flussimetro, connettore a T e flessibile da 60 cm.)

Filtro BWT, testata di fissaggio e flussimetro



Cod. 1527453  
Euro 750,00

Connettore a T



COMPRESO NEL SET

Flessibile da 60 cm



COMPRESO NEL SET

Ricambio filtro a cartuccia



Cod. 1525273  
Euro 363,00



# BLANCO FONTAS-S II

- Miscelatore a 3 vie
- Comandi ed erogatori separati per l'acqua della normale rete idrica e per l'acqua proveniente dal vostro impianto di filtraggio
- Con doccetta estraibile
- Disponibile kit di upgrade alla versione filtro
- Disponibile nel colore Nero Opaco (v. pag. 197) e Satin Gold (v. pag. 200)



Dettagli Colore / Finitura	Codice	Euro
Cromato	1525198	902,00
Finitura PVD Steel <b>NUOVO</b>	1525199	1.032,00



Impostazione di partenza della leva di comando a freddo

Dettagli Colore / Finitura	Codice	Euro
Nero	1526158	965,00
Antracite	1525200	965,00
Grigio Roccia	1525207	965,00
Alumetallic	1525201	965,00
Grigio Vulcano <b>NUOVO</b>	1526946	965,00
Bianco	1525204	965,00
Soft White <b>NUOVO</b>	1526947	965,00
Tartufo	1525206	965,00
Caffè	1525205	965,00

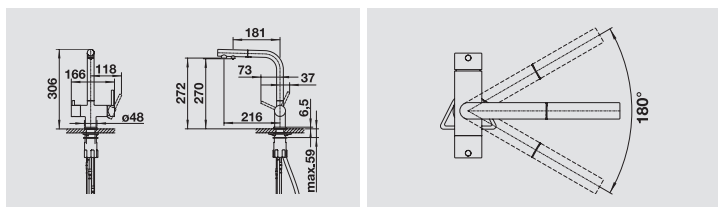

- Escursione della leva comando: 73 mm in avanti e 37 mm indietro rispetto alla mezzeria della canna
- Girevole sino a 180°
- Diametro foro per miscelatore: 35 mm
- Dotato di cartuccia in ceramica
- Filtri di depurazione non in dotazione
- Flessibili da 450 mm con dado da 3/8" per una facile installazione
- Rompigetto brevettato per una marcata riduzione dei depositi di calcare
- Contropiastre di rinforzo per una maggiore stabilità



MISCELATORI

## Accessori

Set di upgrade alla versione **FILTRO** (composto da filtro BWT, testata di fissaggio, flussimetro, connettore a T e flessibile da 60 cm.)

Filtro BWT, testata di fissaggio e flussimetro



Cod. 1527453  
Euro 750,00

Connettore a T



COMPRESO NEL SET

Flessibile da 60 cm



COMPRESO NEL SET

Ricambio filtro a cartuccia



Cod. 1525273  
Euro 363,00



## BLANCO FONTAS II NUOVO Satin Gold

- Miscelatore a 3 vie
- Comandi ed erogatori separati per l'acqua della normale rete idrica e per l'acqua proveniente dal vostro impianto di filtraggio



Impostazione di partenza della leva di comando a freddo



Dettagli Colore / Finitura	Codice	Euro
PVD Satin Gold	1526692	714,00

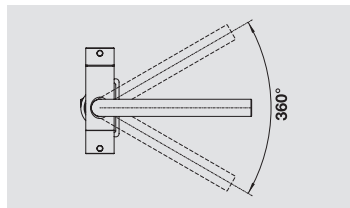
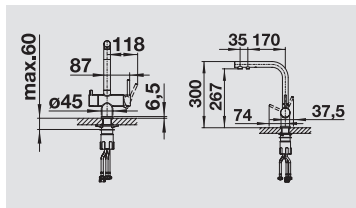

- Escursione della leva comando: 74 mm in avanti e 37,5 mm indietro rispetto alla mezzeria della canna
- Girevole sino a 360°
- Diametro foro per miscelatore: 35 mm
- Dotato di cartuccia in ceramica
- Filtri di depurazione non in dotazione
- Flessibili da 450 mm con dado da 3/8" per una facile installazione
- Rompigetto brevettato per una marcata riduzione dei depositi di calcare
- Contropiastra di rinforzo per una maggiore stabilità
- Certificato LGA



## BLANCO FONTAS-S II NUOVO Satin Gold

- Miscelatore a 3 vie
- Comandi ed erogatori separati per l'acqua della normale rete idrica e per l'acqua proveniente dal vostro impianto di filtraggio
- Con doccetta estraibile



Impostazione di partenza della leva di comando a freddo



Dettagli Colore / Finitura	Codice	Euro
PVD Satin Gold	1526694	1.032,00

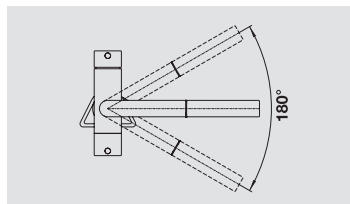
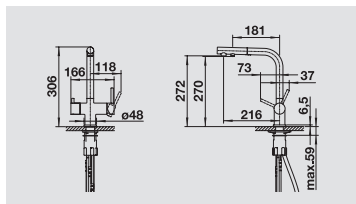

- Escursione della leva comando: 73 mm in avanti e 37 mm indietro rispetto alla mezzeria della canna
- Girevole sino a 180°
- Diametro foro per miscelatore: 35 mm
- Dotato di cartuccia in ceramica
- Filtri di depurazione non in dotazione
- Flessibili da 450 mm con dado da 3/8" per una facile installazione
- Rompigetto brevettato per una marcata riduzione dei depositi di calcare
- Dotato di valvola di non-ritorno certificata EN 1717
- Contropiastra di rinforzo per una maggiore stabilità

### Accessori

Set di upgrade alla versione **FILTRO** (composto da filtro BWT, testata di fissaggio, flussimetro, connettore a T e flessibile da 60 cm.)

Filtro BWT, testata di fissaggio e flussimetro



Cod. 1527453  
Euro 750,00

Connettore a T



COMPRESO NEL SET

Flessibile da 60 cm



COMPRESO NEL SET

Ricambio filtro a cartuccia



Cod. 1525273  
Euro 363,00



reddot award  
winner



## BLANCO CARENA

- Miscelatore dalle linee senza tempo
- A canna alta per agevolare il riempimento di vasi e pentole
- Leva comandi ergonomica, in posizione rialzata
- La leva comandi ruota solo in avanti (max 90°) per agevolare il posizionamento del miscelatore anche a ridosso di pareti posteriori



Dettagli  
Colore / Finitura

Codice Euro

Cromato 1520766 505,00

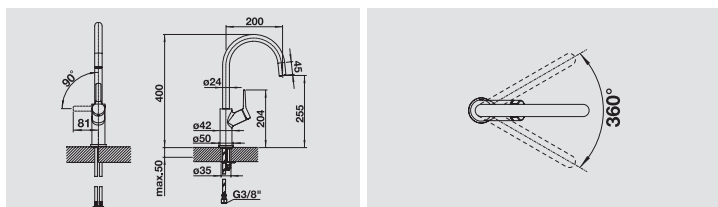

- Girevole sino a 360°
- Diametro foro per miscelatore: 35 mm
- Dotato di cartuccia in ceramica
- Flessibili da 450 mm con dado da 3/8" per una facile installazione
- Rompigetto brevettato per una marcata riduzione dei depositi di calcare
- Contropiastra di rinforzo per una maggiore stabilità
- Certificato LGA e DVGW



reddot award  
winner

## BLANCO CARENA-S

- Doccetta estraibile a scomparsa
- A canna alta per agevolare il riempimento di vasi e pentole
- Leva comandi ergonomica, in posizione rialzata



Doccetta estraibile a scomparsa



Dettagli  
Colore / Finitura

Codice Euro

Cromato 1520767 720,00

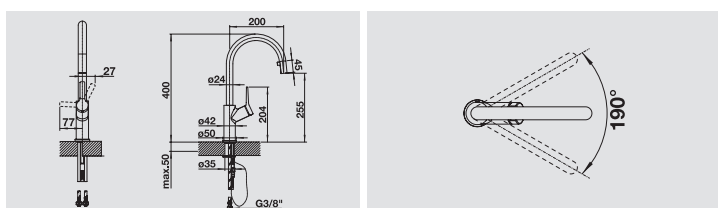

- Escursione della leva comando: 77 mm in avanti e 27 mm indietro rispetto alla mezzeria della canna
- Girevole sino a 190°
- Diametro foro per miscelatore: 35 mm
- Dotato di cartuccia in ceramica
- Doccetta estraibile a scomparsa con fermo posteriore in gomma
- Flessibili da 450 mm con dado da 3/8" per una facile installazione
- Rompigetto brevettato per una marcata riduzione dei depositi di calcare
- Contropiastra di rinforzo per una maggiore stabilità
- Dotato di valvola di non-ritorno certificata EN 1717
- Certificato LGA e DVGW



## BLANCO JURENA

- Design distintivo
- A canna alta per facilitare il riempimento di pentole o vasi voluminosi
- Posizione ergonomica della leva comando
- La leva comandi ruota solo in avanti (max 90°) per agevolare il posizionamento del miscelatore anche a ridosso di pareti posteriori



Dettagli Colore / Finitura	Codice	Euro
Cromato	1520764	505,00

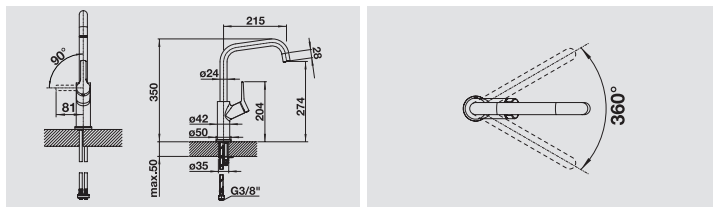

- Girevole sino a 360°
- Diametro foro per miscelatore: 35 mm
- Dotato di cartuccia in ceramica
- Flessibili da 450 mm con dado da 3/8" per una facile installazione
- Rompigetto brevettato per una marcata riduzione dei depositi di calcare
- Contropiastra di rinforzo per una maggiore stabilità
- Certificato LGA e DVGW



## BLANCO JURENA-S

- Innovativa doccetta estraibile a scomparsa
- A canna alta per agevolare il riempimento di pentole voluminose
- Leva comandi ergonomica, in posizione rialzata



Doccetta estraibile a scomparsa



Dettagli Colore / Finitura	Codice	Euro
Cromato	1520765	720,00

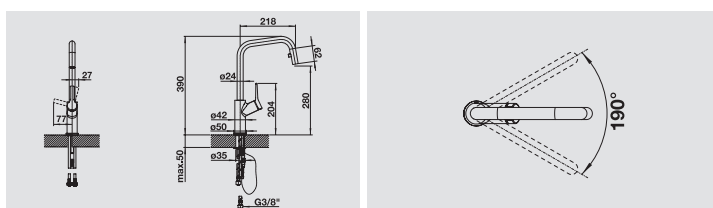

- Escursione della leva comando: 77 mm in avanti e 27 mm indietro rispetto alla mezzeria della canna
- Girevole sino a 190°
- Diametro foro per miscelatore: 35 mm
- Dotato di cartuccia in ceramica
- Doccetta estraibile a scomparsa con fermo posteriore in gomma
- Flessibili da 450 mm con dado da 3/8" per una facile installazione
- Rompigetto brevettato per una marcata riduzione dei depositi di calcare
- Contropiastra di rinforzo per una maggiore stabilità
- Dotato di valvola di non-ritorno certificata EN 1717
- Certificato LGA e DVGW





## BLANCO LINUS

- A canna alta per agevolare il riempimento di vasi o contenitori particolarmente ingombranti
- Disponibile anche nella versione SILGRANIT®
- Adatto per installazione a ridosso della parete posteriore



Dettagli Colore / Finitura	Codice	Euro
-------------------------------	--------	------

Cromato	1514019	352,00
Finitura PVD Steel	1514021	414,00

Versione in acciaio massiccio spazzolato: v. pag. 206

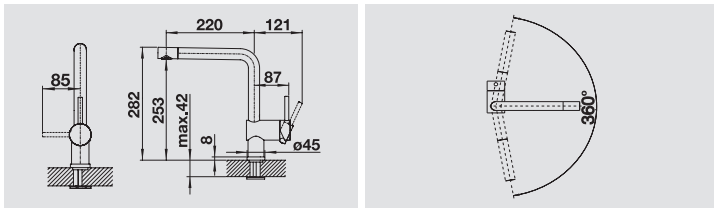

Dettagli Colore / Finitura	Codice	Euro
-------------------------------	--------	------

Nero	1526149	398,00
Antracite	1516698	398,00
Grigio Roccia	1518814	398,00
Alumetallic	1516699	398,00
Grigio Vulcano <b>NUOVO</b>	1526960	398,00
Bianco	1516702	398,00
Soft White <b>NUOVO</b>	1526961	398,00
Tartufo	1517622	398,00
Caffè	1516707	398,00

- Escursione della leva comando: 85 mm in avanti rispetto alla mezzera della canna
- Girevole sino a 360°
- Diametro foro per miscelatore: 35 mm
- Dotato di cartuccia in ceramica
- Flessibili da 450 mm con dado da 3/8" per una facile installazione
- Rompigetto brevettato per una marcata riduzione dei depositi di calcare
- Contropiastra di rinforzo per una maggiore stabilità
- Certificato LGA e DVGW



## BLANCO LINUS-S

- Dotato di doccetta estraibile in metallo di alta qualità
- Miscelatore a canna alta
- Disponibile anche nella versione SILGRANIT®
- Adatto per installazione a ridosso della parete posteriore

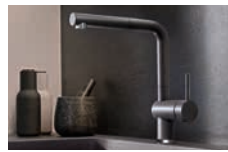

Dettagli Colore / Finitura	Codice	Euro
-------------------------------	--------	------

Cromato	1512402	431,00
Finitura PVD Steel	1512404	499,00

Versione in acciaio massiccio spazzolato: v. pag. 206

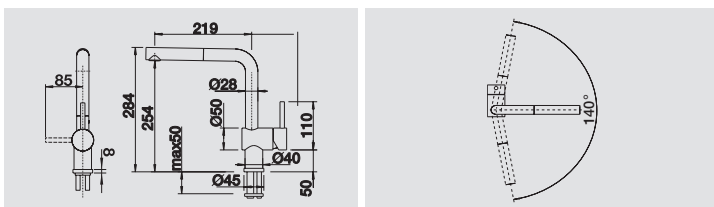

Dettagli Colore / Finitura	Codice	Euro
-------------------------------	--------	------

Nero	1526148	488,00
Antracite	1516688	488,00
Grigio Roccia	1518813	488,00
Alumetallic	1516689	488,00
Grigio Vulcano <b>NUOVO</b>	1526958	488,00
Bianco	1516692	488,00
Soft White <b>NUOVO</b>	1526959	488,00
Tartufo	1517621	488,00
Caffè	1516697	488,00

- Escursione della leva comando: 85 mm in avanti rispetto alla mezzera della canna
- Girevole sino a 140°
- Diametro foro per miscelatore: 35 mm
- Dotato di cartuccia in ceramica
- Flessibili da 450 mm con dado da 3/8" per una facile installazione
- Rompigetto brevettato per una marcata riduzione dei depositi di calcare
- Contropiastra di rinforzo per una maggiore stabilità
- Dotato di valvola di non-ritorno certificata EN 1717
- Certificato LGA e DVGW



## BLANCO LINUS Nero Opaco

- Design minimalista
- Finitura della superficie nera opaca
- Rotazione della canna di 360° per una maggiore copertura
- A canna alta per agevolare il riempimento di vasi o contenitori particolarmente ingombranti
- Adatto per installazione a ridosso della parete posteriore
- Perfetto abbinamento con vasche di colore Nero o Total Black



Dettagli Colore / Finitura	Codice	Euro
Nero Opaco	1525806	476,00



Impostazione  
di partenza  
della leva di comando  
a freddo

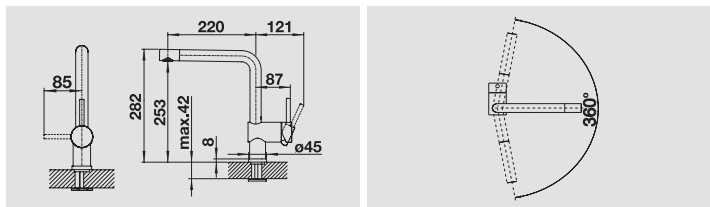

- Escursione della leva comando: 85 mm in avanti rispetto alla mezziera della canna
- Girevole sino a 360°
- Diametro foro per miscelatore: 35 mm
- Dotato di cartuccia in ceramica
- Flessibili da 450 mm con dado da 3/8" per una facile installazione
- Rompigetto brevettato per una marcata riduzione dei depositi di calcare
- Contropiastra di rinforzo per una maggiore stabilità
- Certificato LGA e DVGW



## BLANCO LINUS-S Nero Opaco

- Design minimalista
- Finitura della superficie nera opaca
- Doccetta estraibile in metallo di alta qualità
- Adatto per installazione a ridosso della parete posteriore
- Perfetto abbinamento con vasche di colore Nero o Total Black



Dettagli Colore / Finitura	Codice	Euro
Nero Opaco	1525807	538,00



Impostazione  
di partenza  
della leva di comando  
a freddo

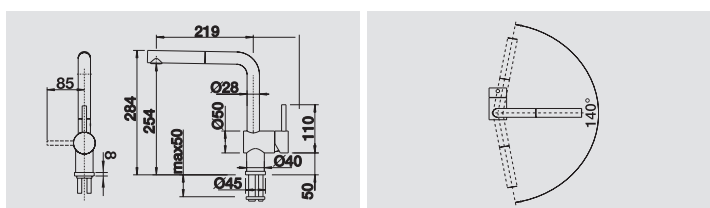

- Escursione della leva comando: 85 mm in avanti rispetto alla mezziera della canna
- Girevole sino a 140°
- Diametro foro per miscelatore: 35 mm
- Dotato di cartuccia in ceramica
- Doccetta estraibile in metallo di alta qualità
- Flessibili da 450 mm con dado da 3/8" per una facile installazione
- Rompigetto brevettato per una marcata riduzione dei depositi di calcare
- Contropiastra di rinforzo per una maggiore stabilità
- Dotato di valvola di non-ritorno certificata EN 1717
- Certificato LGA e DVGW



## BLANCO LINUS **NUOVO** Satin Gold

- Nuova finitura PVD Satin Gold, per un'eleganza assoluta
- A canna alta per agevolare il riempimento di vasi o contenitori particolarmente ingombranti
- Adatto per installazione a ridosso della parete posteriore
- Abbinabile ai dispensers di sapone BLANCO LATO, BLANCO TORRE nella stessa finitura



Dettagli Colore / Finitura	Codice	Euro
PVD Satin Gold	1576683	476,00

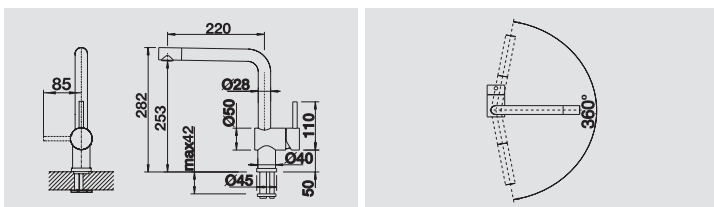

- Escursione della leva comando: 85 mm in avanti rispetto alla mezzeria della canna
- Girevole sino a 360°
- Diametro foro per miscelatore: 35 mm
- Dotato di cartuccia in ceramica
- Flessibili da 450 mm con dado da 3/8" per una facile installazione
- Rompigetto brevettato per una marcata riduzione dei depositi di calcare
- Contropiastra di rinforzo per una maggiore stabilità
- Certificato LGA e DVGW



## BLANCO LINUS-S **NUOVO** Satin Gold

- Nuova finitura PVD Satin Gold, per un'eleganza assoluta
- A canna alta per agevolare il riempimento di vasi o pentole particolarmente voluminose
- Dotato di doccetta estraibile in metallo di alta qualità
- Miscelatore a canna alta
- Abbinabile ai dispensers di sapone BLANCO LATO, BLANCO TORRE nella stessa finitura



Dettagli Colore / Finitura	Codice	Euro
PVD Satin Gold	1526684	538,00

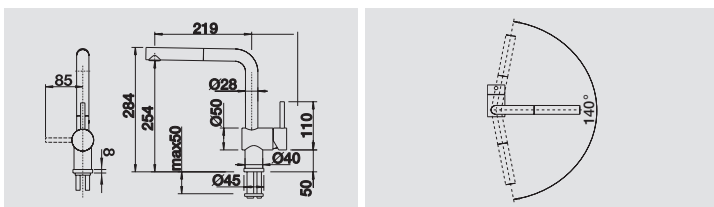

- Escursione della leva comando: 85 mm in avanti rispetto alla mezzeria della canna
- Girevole sino a 140°
- Diametro foro per miscelatore: 35 mm
- Dotato di cartuccia in ceramica
- Flessibili da 450 mm con dado da 3/8" per una facile installazione
- Rompigetto brevettato per una marcata riduzione dei depositi di calcare
- Contropiastra di rinforzo per una maggiore stabilità
- Dotato di valvola di non-ritorno certificata EN 1717
- Certificato LGA e DVGW





## BLANCO LINUS

- A canna alta per agevolare il riempimento di vasi o contenitori particolarmente ingombranti
- Ergonomia del design e affidabilità del materiale
- Adatto per installazione a ridosso della parete posteriore



Dettagli Colore / Finitura	Codice	Euro
-------------------------------	--------	------

Acciaio Massiccio Spazzolato      1517183      511,00

Versione cromata: v. pag. 184



Impostazione di partenza della leva di comando a freddo

**La posizione verticale di partenza della leva, sull'acqua fredda, diminuisce i consumi energetici e aumenta la durata della cartuccia.**

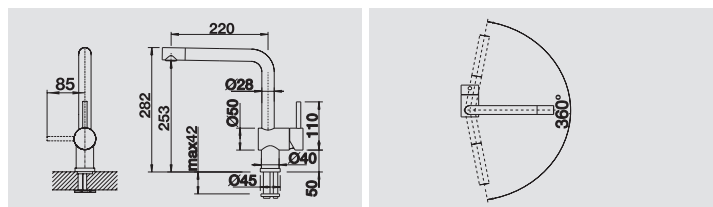

- Escursione della leva comando: 85 mm in avanti rispetto alla mezzeria della canna
- Girevole sino a 360°
- Diametro foro per miscelatore: 35 mm
- Dotato di cartuccia in ceramica
- Flessibili da 450 mm con dado da 3/8" per una facile installazione
- Rompigetto brevettato per una marcata riduzione dei depositi di calcare
- Contropiastra di rinforzo per una maggiore stabilità
- Certificato LGA e DVGW



## BLANCO LINUS-S

- Dotato di doccetta estraibile
- Ergonomia del design e affidabilità del materiale
- Adatto per installazione a ridosso della parete posteriore



Impostazione di partenza della leva di comando a freddo



Dettagli Colore / Finitura	Codice	Euro
-------------------------------	--------	------

Acciaio Massiccio Spazzolato      1517184      692,00

Versione cromata: v. pag. 184

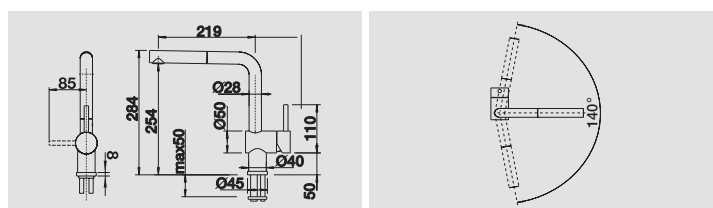

- Escursione della leva comando: 85 mm in avanti rispetto alla mezzeria della canna
- Girevole sino a 140°
- Diametro foro per miscelatore: 35 mm
- Dotato di cartuccia in ceramica
- Flessibili da 450 mm con dado da 3/8" per una facile installazione
- Rompigetto brevettato per una marcata riduzione dei depositi di calcare
- Contropiastra di rinforzo per una maggiore stabilità
- Dotato di valvola di non-ritorno certificata EN 1717
- Certificato LGA e DVGW





## BLANCO AMBIS

- Materiale igienico e duraturo
- Massima libertà d'azione grazie alla canna alta
- Perfetto abbinamento con le cucine più moderne



Dettagli Colore / Finitura	Codice	Euro
Acciaio massiccio spazzolato	1523118	505,00

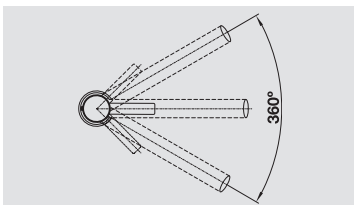
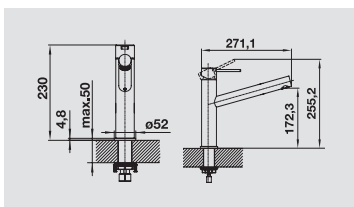

- Girevole sino a 360°
- Diametro foro per miscelatore: 35 mm
- Dotato di cartuccia in ceramica
- Flessibili da 450 mm con dado da 3/8" per una facile installazione
- Rompigetto brevettato per una marcata riduzione dei depositi di calcare
- Contropiastra di rinforzo per una maggiore stabilità
- Certificato LGA e DVGW



## BLANCO AMBIS-S

- Materiale igienico e duraturo
- Massima libertà d'azione grazie alla canna alta
- Dotato di doccetta estraibile
- Selettore del flusso da getto a doccia



Dettagli Colore / Finitura	Codice	Euro
Acciaio massiccio spazzolato	1523119	760,00

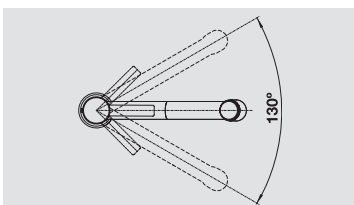
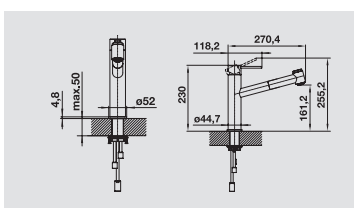

- Girevole sino a 130°
- Diametro foro per miscelatore: 35 mm
- Dotato di cartuccia in ceramica
- Flessibili da 450 mm con dado da 3/8" per una facile installazione
- Rompigetto brevettato per una marcata riduzione dei depositi di calcare
- Contropiastra di rinforzo per una maggiore stabilità
- Dotato di valvola di non-ritorno certificata EN 1717
- Certificato LGA e DVGW



## BLANCO CANDOR

- Solidità ed estetica in acciaio inox
- Rotazione della leva comandi in avanti (max 90°)
- Adatto per installazione a ridosso della parete posteriore

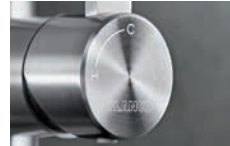

Dettagli Colore / Finitura	Codice	Euro
Acciaio massiccio spazzolato	1523120	329,00



Impostazione di partenza della leva di comando a freddo

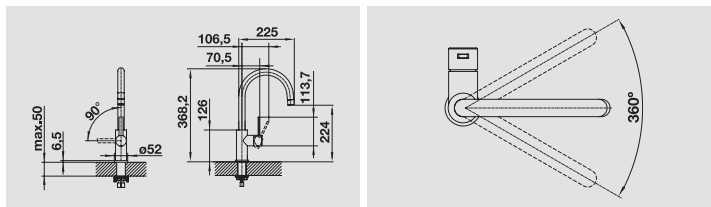

- Escursione della leva comando: 90° in avanti rispetto alla mezzera della canna
- Girevole sino a 360°
- Diametro foro per miscelatore: 35 mm
- Dotato di cartuccia in ceramica
- Flessibili da 450 mm con dado da 3/8" per una facile installazione
- Rompigetto brevettato per una marcata riduzione dei depositi di calcare
- Contropiastra di rinforzo per una maggiore stabilità
- Certificato LGA e DVGW



## BLANCO CANDOR-S

- Solidità ed estetica in acciaio inox
- Rotazione della leva comandi in avanti (max 90°)
- A canna alta, per un riempimento agevole di vasi o pentole voluminosi
- Dotato di doccetta estraibile a scomparsa



Dettagli Colore / Finitura	Codice	Euro
Acciaio massiccio spazzolato	1523121	533,00



Impostazione di partenza della leva di comando a freddo

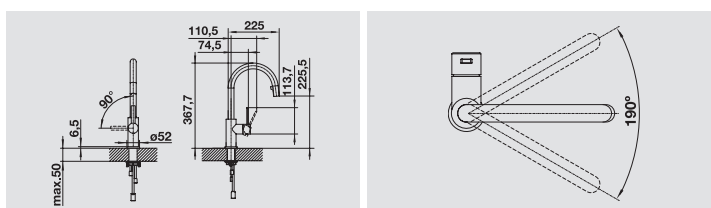

- Girevole sino a 190°
- Diametro foro per miscelatore: 35 mm
- Dotato di cartuccia in ceramica
- Flessibili da 450 mm con dado da 3/8" per una facile installazione
- Rompigetto brevettato per una marcata riduzione dei depositi di calcare
- Contropiastra di rinforzo per una maggiore stabilità
- Dotato di valvola di non-ritorno certificata EN 1717
- Certificato LGA e DVGW



## BLANCO LANORA

- Alta qualità del materiale e geometria lineare
- A canna alta, per riempire agevolmente pentole voluminose
- Adatto per installazione a ridosso della parete posteriore



Dettagli Colore / Finitura	Codice	Euro
Acciaio massiccio spazzolato	1523122	339,00



Impostazione di partenza della leva di comando a freddo

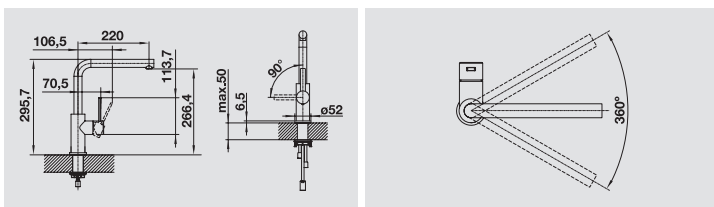

- Escursione della leva comando: 90° in avanti rispetto alla mezzeria della canna
- Girevole sino a 360°
- Diametro foro per miscelatore: 35 mm
- Dotato di cartuccia in ceramica
- Flessibili da 450 mm con dado da 3/8" per una facile installazione
- Rompigetto brevettato per una marcata riduzione dei depositi di calcare
- Contropiastra di rinforzo per una maggiore stabilità
- Certificato LGA e DVGW



## BLANCO LANORA-S

- Alta qualità del materiale e geometria lineare
- A canna alta, per riempire agevolmente pentole voluminose
- Adatto per installazione a ridosso della parete posteriore
- Dotato di doccetta estraibile



Dettagli Colore / Finitura	Codice	Euro
Acciaio massiccio spazzolato	1523123	555,00



Impostazione di partenza della leva di comando a freddo

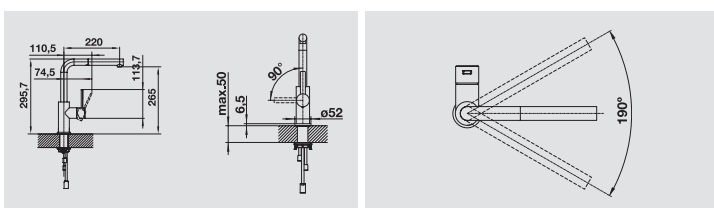

- Escursione della leva comando: 90° in avanti rispetto alla mezzeria della canna
- Girevole sino a 190°
- Diametro foro per miscelatore: 35 mm
- Dotato di cartuccia in ceramica
- Flessibili da 450 mm con dado da 3/8" per una facile installazione
- Rompigetto brevettato per una marcata riduzione dei depositi di calcare
- Contropiastra di rinforzo per una maggiore stabilità
- Dotato di valvola di non-ritorno certificata EN 1717
- Certificato LGA e DVGW



## BLANCO JANDORA **NUOVO**

- Design di alta qualità, in acciaio inossidabile, finitura spazzolata
- Adatto alle cucine moderne
- Canna alta, ad arco, per agevolare il riempimento delle pentole e dei vasi più ingombranti
- Adatto per installazione a ridosso della parete posteriore
- Risparmio energetico: impostazione di partenza della leva di comando a freddo



Dettagli Colore / Finitura	Codice	Euro
Acciaio Massiccio Spazzolato	1526615	318,00



Impostazione di partenza della leva di comando a freddo

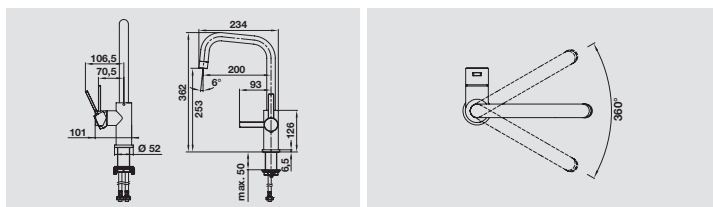

- Escursione della leva comandi: 93 mm in avanti rispetto alla mezzzeria della canna
- Girevole sino a 360°
- Diametro foro per miscelatore: 35 mm
- Dotato di cartuccia in ceramica
- Flessibili da 700 mm con dado da 3/8" per una facile installazione
- Rompigetto brevettato per una marcata riduzione dei depositi di calcare
- Contropiastra di rinforzo per una maggiore stabilità
- Dotato di valvola di non-ritorno certificata EN 1717
- Certificato LGA



## BLANCO JANDORA-S **NUOVO**

- Design di alta qualità, in acciaio inossidabile, finitura spazzolata
- Adatto alle cucine moderne
- Canna alta, ad arco, per agevolare il riempimento delle pentole e dei vasi più ingombranti
- Adatto per installazione a ridosso della parete posteriore
- Risparmio energetico: impostazione di partenza della leva di comando a freddo
- Doccetta estraibile a scomparsa



Dettagli Colore / Finitura	Codice	Euro
Acciaio Massiccio Spazzolato	1526614	511,00



Impostazione di partenza della leva di comando a freddo

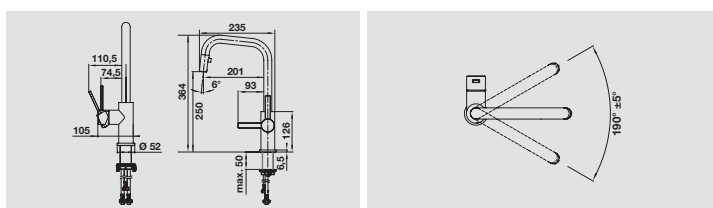

- Escursione della leva comandi: 93 mm in avanti rispetto alla mezzzeria della canna
- Girevole sino a 190°
- Diametro foro per miscelatore: 35 mm
- Dotato di cartuccia in ceramica
- Flessibili da 700 mm con dado da 3/8" per una facile installazione
- Rompigetto brevettato per una marcata riduzione dei depositi di calcare
- Contropiastra di rinforzo per una maggiore stabilità
- Dotato di valvola di non-ritorno certificata EN 1717
- Certificato LGA





## BLANCO TIVO

- Canna rialzata per agevolare il lavoro nel lavello
- Girevole a 360° per agevolare le operazioni di risciacquo e pulizia



Dettagli Colore / Finitura	Codice	Euro
Cromato	1517599	437,00

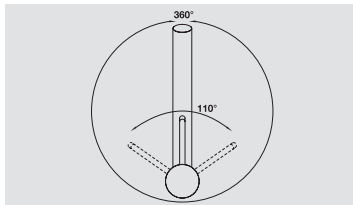
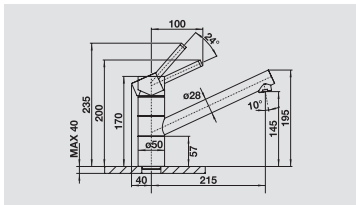

- Girevole sino a 360° (110° per la leva-comandi)
- Diametro foro per miscelatore: 35 mm
- Dotato di cartuccia in ceramica
- Flessibili da 450 mm con dado da 3/8" per una facile installazione
- Contropiastra di rinforzo per una maggiore stabilità
- Rompigetto brevettato per una marcata riduzione dei depositi di calcare
- Certificato LGA e DVGW



## BLANCO TIVO-S

- Canna rialzata per agevolare il lavoro nel lavello
- Disponibile anche nella versione SILGRANIT®
- Doccetta estraibile con tasto per selezione del tipo di getto



Dettagli Colore / Finitura	Codice	Euro
Cromato	1517648	550,00

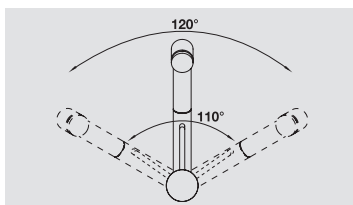
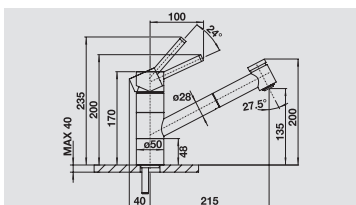

Dettagli Colore / Finitura	Codice	Euro
-------------------------------	--------	------

Nero/Cromato	1526279	679,00
Antracite/Cromato	1517610	679,00
Grigio Roccia/Cromato	1518798	679,00
Alumetallic/Cromato	1517611	679,00
Grigio Vulcano/Cromato	<b>NUOVO</b> 1526976	679,00
Bianco/Cromato	1517613	679,00
Soft White/Cromato	<b>NUOVO</b> 1526977	679,00
Tartufo/Cromato	1517619	679,00
Caffè/Cromato	1517618	679,00

- Girevole sino a 120° (110° per la leva-comandi)
- Diametro foro per miscelatore: 35 mm
- Dotato di cartuccia in ceramica
- Flessibili da 450 mm con dado da 3/8" per una facile installazione
- Rompigetto brevettato per una marcata riduzione dei depositi di calcare
- Contropiastra di rinforzo per una maggiore stabilità
- Dotato di valvola di non-ritorno certificata EN 1717
- Certificato LGA e DVGW



## BLANCO ANTAS

- Linee severe e design essenziale
- Adatto ai lavelli di dimensioni più ridotte



Dettagli Colore / Finitura	Codice	Euro
Cromato	1515337	284,00

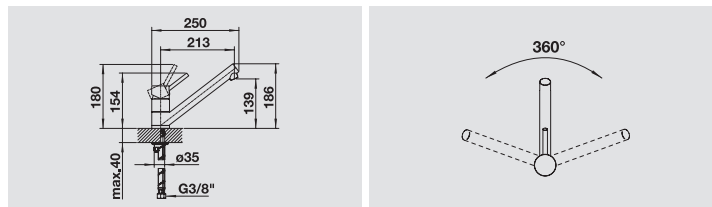

- Girevole sino a 360°
- Diametro foro per miscelatore: 35 mm
- Dotato di cartuccia in ceramica
- Flessibili da 450 mm con dado da 3/8" per una facile installazione
- Rompigetto brevettato per una marcata riduzione dei depositi di calcare
- Contropiastra di rinforzo per una maggiore stabilità
- Certificato LGA e DVGW



## BLANCO ANTAS-S

- Linee severe e design essenziale
- Adatto ai lavelli di dimensioni più ridotte
- Dotato di doccetta estraibile



Dettagli Colore / Finitura	Codice	Euro
Cromato	1515348	408,00

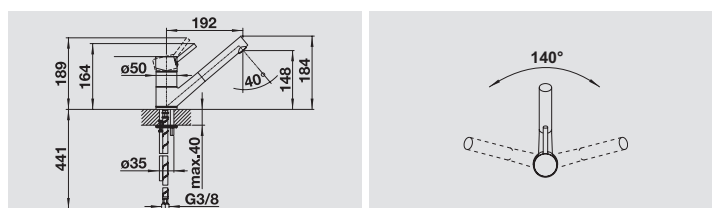

- Girevole sino a 140°
- Diametro foro per miscelatore: 35 mm
- Dotato di cartuccia in ceramica
- Flessibili da 450 mm con dado da 3/8" per una facile installazione
- Rompigetto brevettato per una marcata riduzione dei depositi di calcare
- Contropiastra di rinforzo per una maggiore stabilità
- Dotato di valvola di non-ritorno certificata EN 1717
- Certificato LGA e DVGW

# BLANCO TRIMA **NUOVO**

- Miscelatore a 3 vie con comando ergonomico di chiara identificazione delle funzioni
- Comandi separati per l'acqua della normale rete idrica e per l'acqua proveniente dal vostro impianto di filtraggio
- Canna integrata per entrambe le funzioni, con speciale rompigitto
- Disponibile kit di upgrade alla versione filtro



Particolare delle leve comandi

Speciale rompigitto



Dettagli Colore / Finitura	Codice	Euro
Cromato	1520840	555,00

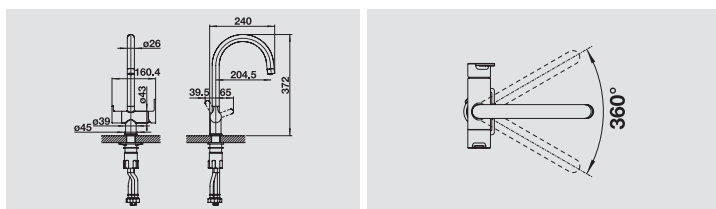

- Escursione della leva comandi: 65 mm in avanti e 39,5 mm indietro rispetto alla mezzeria della canna
- Girevole sino a 360°
- Diametro foro per miscelatore: 35 mm
- Dotato di cartuccia in ceramica
- Filtri di depurazione non in dotazione
- Flessibili da 450 mm con dado da 3/8" per una facile installazione
- Rompigitto brevettato per una marcata riduzione dei depositi di calcare
- Contropiastre di rinforzo per una maggiore stabilità
- Certificato LGA

# BLANCO TRIMA **NUOVO** Satin Gold

- Miscelatore a 3 vie nella nuova finitura PVD Satin Gold
- Comandi separati per l'acqua della normale rete idrica e per l'acqua proveniente dal vostro impianto di filtraggio
- Canna integrata per entrambe le funzioni, con speciale rompigitto
- Disponibile kit di upgrade alla versione filtro



Particolare delle leve comandi

Speciale rompigitto



Dettagli Colore / Finitura	Codice	Euro
PVD Satin Gold	1526695	703,00

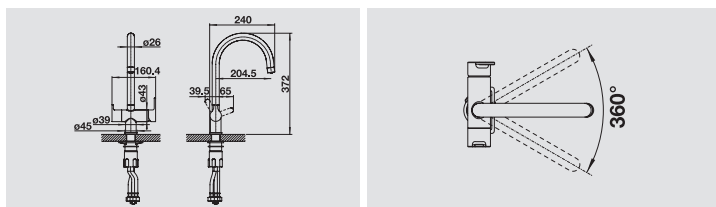

- Escursione della leva comandi: 65 mm in avanti e 39,5 mm indietro rispetto alla mezzeria della canna
- Girevole sino a 360°
- Diametro foro per miscelatore: 35 mm
- Dotato di cartuccia in ceramica
- Filtri di depurazione non in dotazione
- Flessibili da 450 mm con dado da 3/8" per una facile installazione
- Rompigitto brevettato per una marcata riduzione dei depositi di calcare
- Contropiastre di rinforzo per una maggiore stabilità
- Dotato di valvola di non-ritorno certificata EN 1717
- Certificato LGA

## Accessori

**Set di upgrade alla versione FILTRO**  
(composto da filtro BWT, testata di fissaggio, flussimetro, connettore a T e flessibile da 60 cm.)

**Filtro BWT, testata di fissaggio e flussimetro**



Cod. 1527453  
Euro 750,00

**Connettore a T**



COMPRESO NEL SET

**Flessibile da 60 cm**



COMPRESO NEL SET

**Ricambio filtro a cartuccia**



Cod. 1525273  
Euro 363,00





## BLANCO MIDA

- Design essenziale per un'ottima praticità
- Miscelatore a canna alta per agevolare il riempimento di vasi o contenitori particolarmente ingombranti
- Disponibile in Nero Opaco (v. pag. successiva)



Dettagli Colore / Finitura	Codice	Euro
-------------------------------	--------	------

Cromato	1517742	205,00
---------	---------	--------

Dettagli Colore / Finitura	Codice	Euro
-------------------------------	--------	------

Nero	1526145	223,00
Antracite	1519415	223,00
Alumetallic	1519416	223,00
Grigio Vulcano <b>NUOVO</b>	1526965	223,00
Bianco	1519418	223,00
Soft White <b>NUOVO</b>	1526966	223,00
Caffè	1519423	223,00

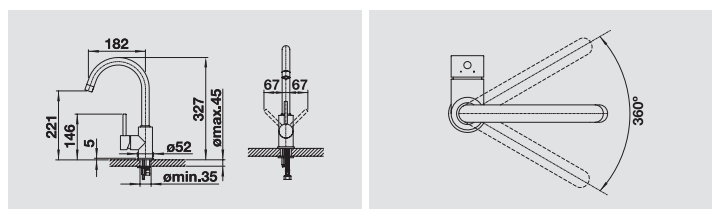

- Escursione della leva comando: 67 mm in avanti e indietro rispetto alla mezzeria della canna
- Girevole sino a 360°
- Diametro foro per miscelatore: 35 mm
- Dotato di cartuccia in ceramica
- Flessibili da 350 mm con dado da 3/8" per una facile installazione
- Contropiastra di rinforzo per una maggiore stabilità
- Certificato LGA e DVGW



## BLANCO MIDA-S

- Miscelatore a canna alta per agevolare il riempimento di vasi o contenitori particolarmente ingombranti
- Dotato di doccetta estraibile
- Disponibile in Nero Opaco (v. pag. successiva)

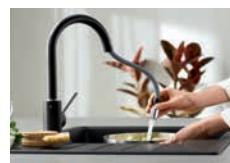

Dettagli Colore / Finitura	Codice	Euro
-------------------------------	--------	------

Cromato	1521454	379,00
---------	---------	--------

Dettagli Colore / Finitura	Codice	Euro
-------------------------------	--------	------

Nero	1526146	434,00
Antracite	1521455	434,00
Alumetallic	1521456	434,00
Grigio Vulcano <b>NUOVO</b>	1526967	434,00
Bianco	1521457	434,00
Soft White <b>NUOVO</b>	1526968	434,00
Caffè	1521461	434,00

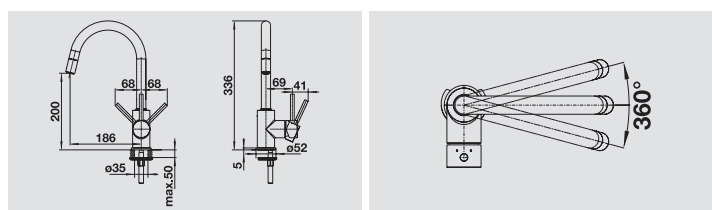

- Escursione della leva comando: 68 mm in avanti e indietro rispetto alla mezzeria della canna
- Girevole sino a 360°
- Diametro foro per miscelatore: 35 mm
- Dotato di cartuccia in ceramica
- Flessibili da 350 mm con dado da 3/8" per una facile installazione
- Rompigetto brevettato per una marcata riduzione dei depositi di calcare
- Dotato di valvola di non-ritorno certificata EN 1717
- Contropiastra di rinforzo per una maggiore stabilità
- Certificato LGA e DVGW





## BLANCO MIDA **NUOVO**

### Nero Opaco

- Design essenziale per un'ottima praticità
- Finitura in Nero Opaco, perfetta in ogni cucina
- A canna alta per agevolare il riempimento di vasi o contenitori particolarmente ingombranti
- Perfetto abbinamento con vasche di colore Nero o Total Black



Dettagli Colore / Finitura	Codice	Euro
Nero Opaco	1526649	261,00

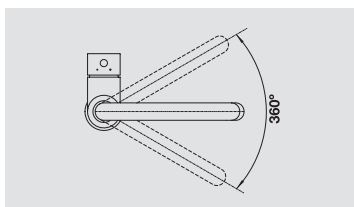
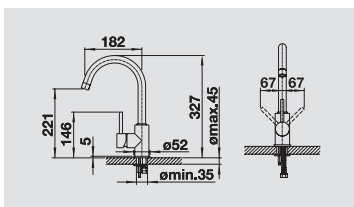

- Escursione della leva comando: 67 mm in avanti e indietro rispetto alla mezziera della canna
- Girevole sino a 360°
- Diametro foro per miscelatore: 35 mm
- Dotato di cartuccia in ceramica
- Flessibili da 350 mm con dado da 3/8" per una facile installazione
- Contropiastra di rinforzo per una maggiore stabilità
- Certificato LGA e DVGW



## BLANCO MIDA-S **NUOVO**

### Nero Opaco

- Design essenziale per un'ottima praticità
- Finitura in Nero Opaco, perfetta in ogni cucina
- A canna alta per agevolare il riempimento di vasi o contenitori particolarmente ingombranti
- Dotato di doccetta estraibile
- Perfetto abbinamento con vasche di colore Nero o Total Black



Dettagli Colore / Finitura	Codice	Euro
Nero Opaco	1526653	434,00

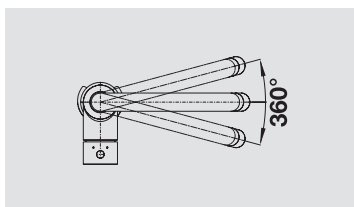
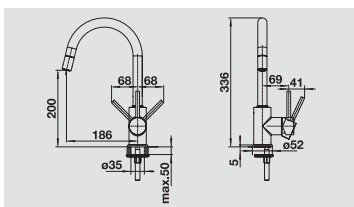

- Escursione della leva comando: 68 mm in avanti e indietro rispetto alla mezziera della canna
- Girevole sino a 360°
- Diametro foro per miscelatore: 35 mm
- Dotato di cartuccia in ceramica
- Flessibili da 350 mm con dado da 3/8" per una facile installazione
- Rompigetto brevettato per una marcata riduzione dei depositi di calcare
- Dotato di valvola di non-ritorno certificata EN 1717
- Contropiastra di rinforzo per una maggiore stabilità
- Certificato LGA e DVGW



## BLANCO MILA

- Design essenziale per un'ottima praticità
- Miscelatore a canna alta per agevolare il riempimento di vasi o contenitori particolarmente ingombranti



Dettagli Colore / Finitura	Codice	Euro
Cromato	1519414	216,00

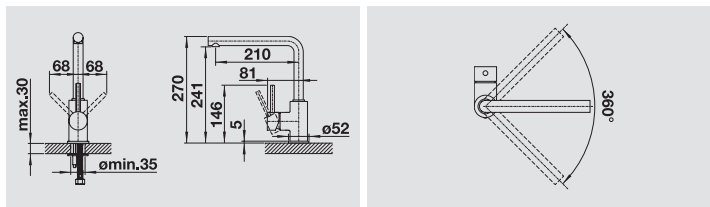

- Escursione della leva comando: 68 mm in avanti e indietro rispetto alla mezziera della canna
- Girevole sino a 360°
- Diametro foro per miscelatore: 35 mm
- Dotato di cartuccia in ceramica
- Flessibili da 350 mm con dado da 3/8" per una facile installazione
- Contropiastra di rinforzo per una maggiore stabilità
- Certificato LGA e DVGW



## BLANCO MILA-S

- Design essenziale per un'ottima praticità
- Con doccetta estraibile
- Miscelatore a canna alta per agevolare il riempimento di vasi o contenitori particolarmente ingombranti



Dettagli Colore / Finitura	Codice	Euro
Cromato	1519810	416,00

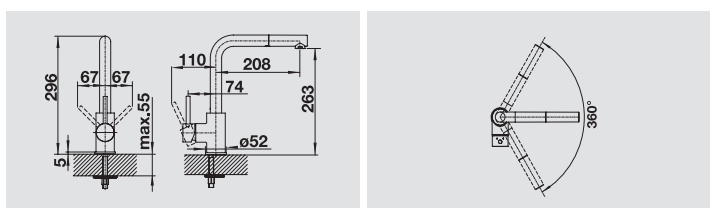

- Escursione della leva comando: 67 mm in avanti e indietro rispetto alla mezziera della canna
- Girevole sino a 360°
- Diametro foro per miscelatore: 35 mm
- Dotato di cartuccia in ceramica
- Flessibili da 350 mm con dado da 3/8" per una facile installazione
- Dotato di valvola di non-ritorno certificata EN 1717
- Certificato LGA e DVGW



## BLANCO MILA **NUOVO**

### Nero Opaco

- Design essenziale per un'ottima praticità
- Finitura in Nero Opaco, perfetta in ogni cucina
- Miscelatore a canna alta per agevolare il riempimento di vasi o contenitori particolarmente ingombranti
- Perfetto abbinamento con vasche di colore Nero o Total Black



Dettagli Colore / Finitura	Codice	Euro
Nero Opaco	1526657	235,00

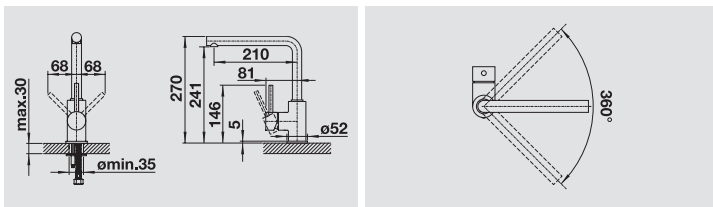

- Escursione della leva comando: 68 mm in avanti e indietro rispetto alla mezziera della canna
- Girevole sino a 360°
- Diametro foro per miscelatore: 35 mm
- Dotato di cartuccia in ceramica
- Flessibili da 350 mm con dado da 3/8" per una facile installazione
- Contropiastra di rinforzo per una maggiore stabilità
- Certificato LGA e DVGW

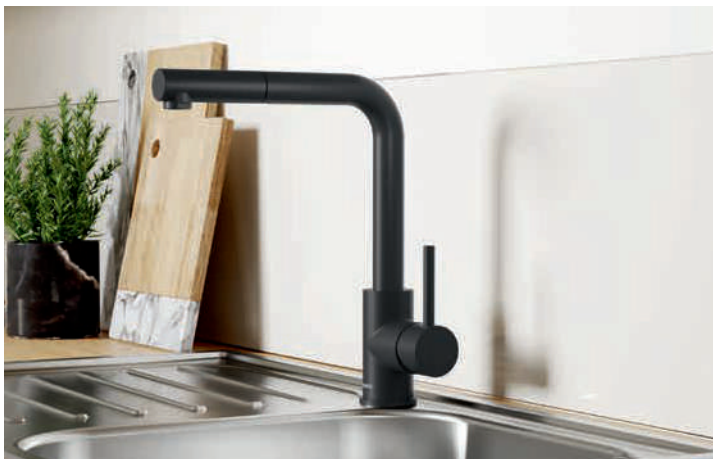

## BLANCO MILA-S **NUOVO**

### Nero Opaco

- Design essenziale per un'ottima praticità
- Finitura in Nero Opaco, perfetta in ogni cucina
- Con doccetta estraibile
- Miscelatore a canna alta per agevolare il riempimento di vasi o contenitori particolarmente ingombranti
- Perfetto abbinamento con vasche di colore Nero o Total Black



Dettagli Colore / Finitura	Codice	Euro
Nero Opaco	1526660	423,00

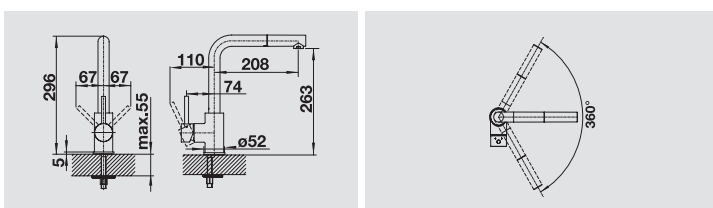

- Escursione della leva comando: 67 mm in avanti e indietro rispetto alla mezziera della canna
- Girevole sino a 360°
- Diametro foro per miscelatore: 35 mm
- Dotato di cartuccia in ceramica
- Flessibili da 350 mm con dado da 3/8" per una facile installazione
- Dotato di valvola di non-ritorno certificata EN 1717
- Certificato LGA e DVGW



## BLANCO MILÌ

- Design essenziale per un'ottima praticità
- Miscelatore a canna alta per agevolare il riempimento di vasi o contenitori particolarmente ingombranti
- Disponibile anche nella versione SILGRANIT®



Dettagli Colore / Finitura	Codice	Euro
-------------------------------	--------	------

Cromato	1519413	216,00
---------	---------	--------

Dettagli Colore / Finitura	Codice	Euro
-------------------------------	--------	------

Nero	1526159	241,00
Antracite	1523103	241,00
Alumetallico	1523105	241,00
Grigio Vulcano <b>NUOVO</b>	1527460	241,00
Bianco	1523107	241,00
Soft White <b>NUOVO</b>	1527461	241,00
Caffè	1523111	241,00

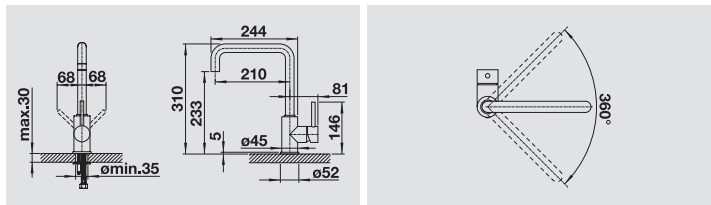

- Escursione della leva comando: 68 mm in avanti e indietro rispetto alla mezzera della canna
- Girevole sino a 360°
- Diametro foro per miscelatore: 35 mm
- Dotato di cartuccia in ceramica
- Flessibili da 350 mm con dado da 3/8" per una facile installazione
- Rompigetto brevettato per una marcata riduzione dei depositi di calcare
- Contropiastra di rinforzo per una maggiore stabilità
- Certificato LGA e DVGW



## BLANCO MILÌ **NUOVO**

### Nero Opaco

- Design essenziale per un'ottima praticità
- Finitura in Nero Opaco, perfetta in ogni cucina
- Miscelatore a canna alta per agevolare il riempimento di vasi o contenitori particolarmente ingombranti
- Perfetto abbinamento con vasche di colore Nero o Total Black



Dettagli Colore / Finitura	Codice	Euro
-------------------------------	--------	------

Nero Opaco	1526665	249,00
------------	---------	--------

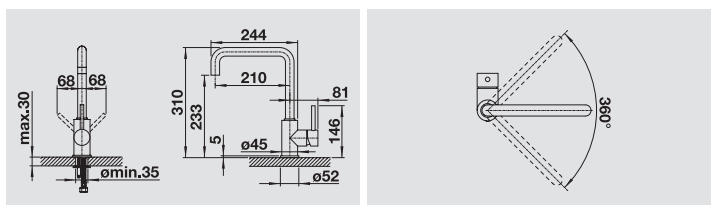

- Escursione della leva comando: 68 mm in avanti e indietro rispetto alla mezzera della canna
- Girevole sino a 360°
- Diametro foro per miscelatore: 35 mm
- Dotato di cartuccia in ceramica
- Flessibili da 350 mm con dado da 3/8" per una facile installazione
- Contropiastra di rinforzo per una maggiore stabilità
- Certificato LGA e DVGW





## BLANCO DARAS

- Disponibile anche nella versione SILGRANIT®
- Ottimo rapporto qualità-prezzo
- Maggiore raggio di azione grazie alla rotazione a 360°



Dettagli Colore / Finitura	Codice	Euro
-------------------------------	--------	------

Cromato	1517720	111,00
---------	---------	--------

Dettagli Colore / Finitura	Codice	Euro
-------------------------------	--------	------

Nero	1526152	169,00
Antracite	1517721	169,00
Alumetallic	1517722	169,00
Grigio Vulcano <b>NUOVO</b>	1526934	169,00
Bianco	1517724	169,00
Soft White <b>NUOVO</b>	1526935	169,00
Caffè	1517729	169,00

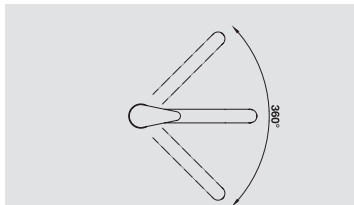
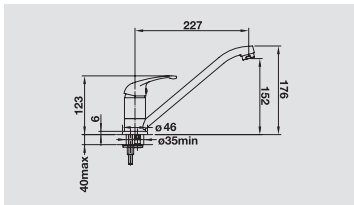

- Girevole sino a 360°
- Diametro foro per miscelatore: 35 mm
- Dotato di cartuccia in ceramica
- Flessibili da 500 mm con dado da 3/8" per una facile installazione
- Certificato LGA



## BLANCO DARAS-S

- Dotato di doccetta estraibile
- Disponibile anche nella versione SILGRANIT®
- Particolarmente adatto ai lavelli di dimensioni più ridotte



Dettagli Colore / Finitura	Codice	Euro
-------------------------------	--------	------

Cromato	1517731	193,00
---------	---------	--------

Dettagli Colore / Finitura	Codice	Euro
-------------------------------	--------	------

Nero	1526153	282,00
Antracite	1517732	282,00
Alumetallic	1517733	282,00
Grigio Vulcano <b>NUOVO</b>	1526936	282,00
Bianco	1517735	282,00
Soft White <b>NUOVO</b>	1526937	282,00
Caffè	1517740	282,00

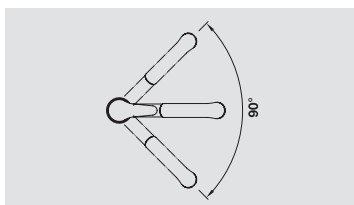
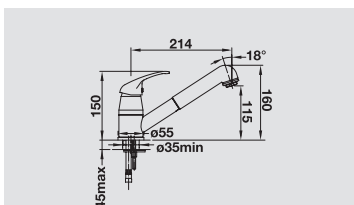

- Girevole sino a 90°
- Diametro foro per miscelatore: 35 mm
- Dotato di cartuccia in ceramica
- Flessibili da 500 mm con dado da 3/8" per una facile installazione
- Contropiastra di rinforzo per una maggiore stabilità
- Dotato di valvola di non-ritorno certificata EN 1717
- Certificato LGA



## BLANCO ELOSCOPE-F II

- Miscelatore per installazione sottofinestra
- Design chiaro, senza compromessi
- Altezza max. 256 mm
- Necessari 2 fori da 35 mm di diametro per miscelatore e leva-comandi
- BLANCO ELOSCOPE-F II resta comunque funzionante in qualsiasi posizione si trovi



Dettagli Colore / Finitura	Codice	Euro
Cromato	1516672	1.265,00

**N.B.:** altezza minima tra lavello e finestra: 3 cm - verificare fattibilità d'inserimento sul lavello scelto - profondità d'installazione nella base sottolavello: 470 mm (inclusi flessibili).  
istanza tra mezzeria foro-erogatore e mezzeria foro-manopola: min. 70 mm, max 500 mm

**Non è possibile installare questo miscelatore direttamente dietro il troppopieno dei lavelli -IF/A con fascia miscelatore ANDANO, CLARON, ZEROX, SOLIS, SUPRA**

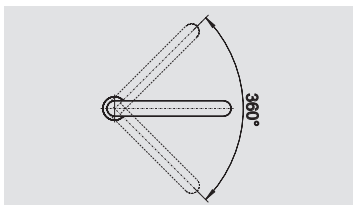
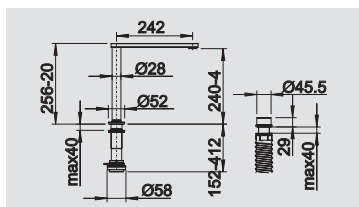

- Miscelatore estraibile
- Girevole sino a 360°
- Diametro foro per miscelatore e per leva comandi: 35 mm
- Dotato di cartuccia in ceramica
- Flessibili da 750 mm con dado da 3/8" per una facile installazione
- Doccetta brevettata per una marcata riduzione dei depositi di calcare
- Certificato LGA



## BLANCO TIVO-F **NUOVO**

- Miscelatore abbattibile per installazione sottofinestra
- Girevole a 360° per agevolare le operazioni di risciacquo e pulizia



Dettagli Colore / Finitura	Codice	Euro
Cromato	1518408	658,00

**N.B.:** Altezza minima tra lavello e finestra: 4,5 cm

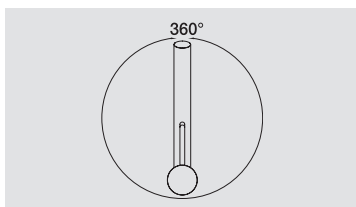
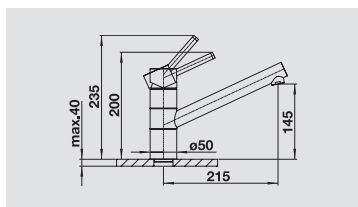

- Miscelatore abbattibile
- Girevole sino a 360°
- Diametro foro per miscelatore: 35 mm
- Dotato di cartuccia in ceramica
- Flessibili da 750 mm con dado da 3/8" per una facile installazione
- Rompigetto brevettato per una marcata riduzione dei depositi di calcare
- Contropiastra di rinforzo per una maggiore stabilità
- Certificato LGA e DVGW

## BLANCO TIVO-S-F **NUOVO**

- Miscelatore abbattibile per installazione sottofinestra
- Dotato di doccetta estraibile con tasto per la variazione del getto



Dettagli Colore / Finitura	Codice	Euro
Cromato	1518410	760,00

**N.B.:** Altezza minima tra lavello e finestra: 5,5 cm

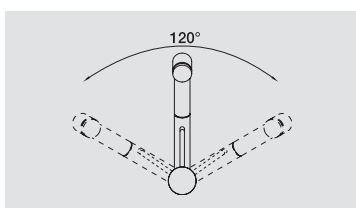
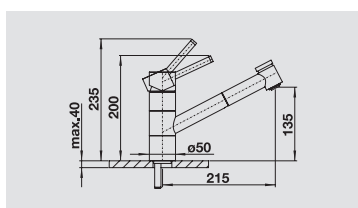

- Miscelatore abbattibile
- Girevole sino a 120°
- Diametro foro per miscelatore: 35 mm
- Dotato di cartuccia in ceramica
- Flessibili da 750 mm con dado da 3/8" per una facile installazione
- Rompigetto brevettato per una marcata riduzione dei depositi di calcare
- Dotato di valvola di non-ritorno certificata EN 1717
- Contropiastra di rinforzo per una maggiore stabilità
- Certificato LGA e DVGW

MISCELATORI



**NUOVO**

# BLANCO LANORA-F



- Miscelatore per installazione sottofinestra
- Design e materiali di alta qualità
- A canna alta, per agevolare il riempimento anche dei contenitori più ingombranti
- Più libertà di movimento per l'installazione a ridosso della parete grazie alla leva di comando con posizione verticale neutra



Dettagli Colore / Finitura	Codice	Euro
Acciaio Massiccio Spazzolato	1526179	493,00

**N.B.:** Altezza minima tra lavello e finestra: 2,5 cm



Impostazione di partenza della leva di comando a freddo

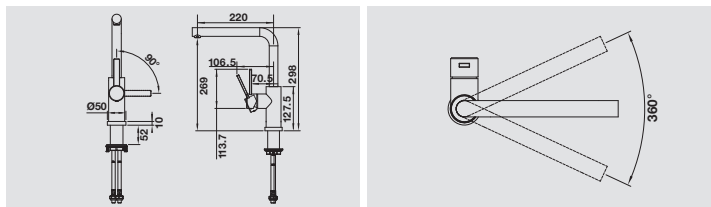

- Escursione della leva comando: 90° in avanti rispetto la mezzeria della canna
- Miscelatore abbattibile
- Girevole sino a 360°
- Diametro foro per miscelatore: 35 mm
- Dotato di cartuccia in ceramica
- Flessibili da 985 mm con dado da 3/8" per una facile installazione
- Rompigetto brevettato per una marcata riduzione dei depositi di calcare
- Contropiastra di rinforzo per una maggiore stabilità
- Certificato LGA e DVGW

MISCELATORI

**NUOVO**

# BLANCO LANORA-S-F



- Miscelatore per installazione sottofinestra
- Design e materiali di alta qualità
- A canna alta, per agevolare il riempimento anche dei contenitori più ingombranti
- Più libertà di movimento per l'installazione a ridosso della parete grazie alla leva di comando con posizione verticale neutra
- Dotato di doccetta estraibile



Dettagli Colore / Finitura	Codice	Euro
Acciaio Massiccio Spazzolato	1526180	789,00

**N.B.:** Altezza minima tra lavello e finestra: 4,5 cm



Impostazione di partenza della leva di comando a freddo

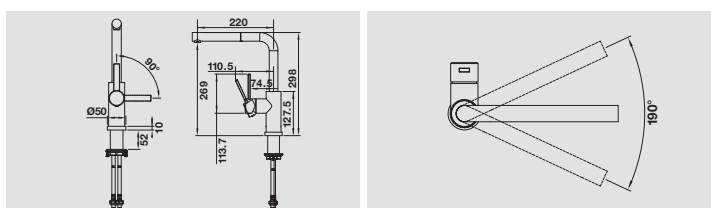

- Escursione della leva comando: 90° in avanti rispetto la mezzeria della canna
- Miscelatore abbattibile
- Girevole sino a 190°
- Diametro foro per miscelatore: 35 mm
- Dotato di cartuccia in ceramica
- Flessibili da 985 mm con dado da 3/8" per una facile installazione
- Rompigetto brevettato per una marcata riduzione dei depositi di calcare
- Dotato di valvola di non-ritorno certificata EN 1717
- Contropiastra di rinforzo per una maggiore stabilità
- Certificato LGA e DVGW





## BLANCO LINUS-F

- Miscelatore abbattibile per installazione sottofinestra
- Funzionamento semplicissimo: si solleva e si ripone a lato
- Design minimalista
- Doccetta girevole in metallo di alta qualità
- A canna alta per agevolare il riempimento di vasi o contenitori particolarmente ingombranti



Dettagli Colore / Finitura	Codice	Euro
Cromato	1514025	398,00

**N.B.:** Altezza minima tra lavello e finestra: 2,5 cm



Impostazione di partenza della leva di comando a freddo

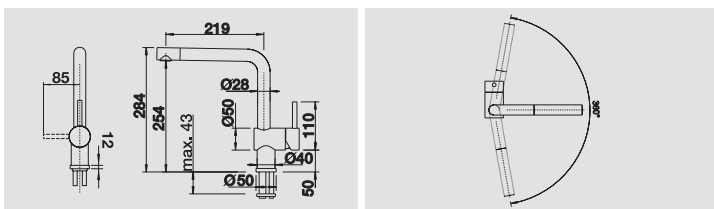

- Escursione della leva comando: 85 mm rispetto la mezzeria della canna
- Miscelatore abbattibile
- Girevole sino a 360°
- Diametro foro per miscelatore: 35 mm
- Dotato di cartuccia in ceramica
- Flessibili da 750 mm con dado da 3/8" per una facile installazione
- Rompigetto brevettato per una marcata riduzione dei depositi di calcare
- Contropiastra di rinforzo per una maggiore stabilità
- Certificato LGA e DVGW



## BLANCO LINUS-S-F

- Miscelatore per installazione sottofinestra
- Funzionamento semplicissimo: si solleva e si ripone a lato
- Design essenziale per un'ottima praticità
- Dotato di doccetta estraibile
- A canna alta per agevolare il riempimento di vasi o contenitori particolarmente ingombranti



Dettagli Colore / Finitura	Codice	Euro
Cromato	1514023	562,00

**N.B.:** Altezza minima tra lavello e finestra: 4,5 cm



Impostazione di partenza della leva di comando a freddo

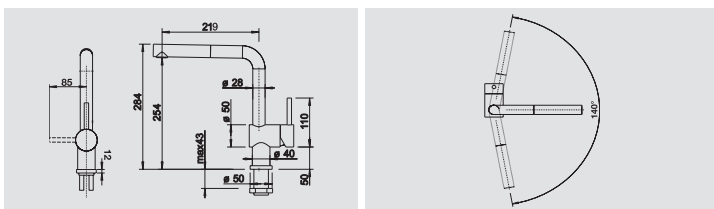

- Escursione della leva comando: 85 mm rispetto la mezzeria della canna
- Miscelatore abbattibile
- Girevole sino a 140°
- Diametro foro per miscelatore: 35 mm
- Dotato di cartuccia in ceramica
- Flessibili da 750 mm con dado da 3/8" per una facile installazione
- Rompigetto brevettato per una marcata riduzione dei depositi di calcare
- Contropiastra di rinforzo per una maggiore stabilità
- Dotato di valvola di non-ritorno certificata EN 1717
- Certificato LGA e DVGW



## BLANCO CORESSA-F

- Miscelatore pieghevole per installazione sottofinestra con meccanismo
- Disponibile con leva destra o sinistra
- A canna alta per agevolare il riempimento di vasi o contenitori particolarmente ingombranti



Dettagli Colore / Finitura	Codice	Euro
Cromato - Leva DX	1521543	505,00
Cromato - Leva SX	1521544	505,00

**N.B.:** Altezza minima tra lavello e finestra: 6,5 cm

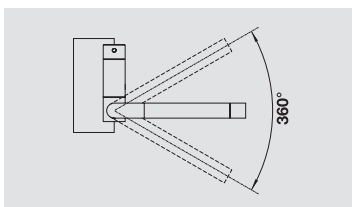
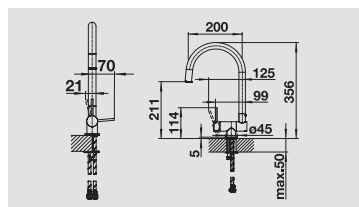

- Miscelatore pieghevole
- Girevole sino a 360°
- Diametro foro per miscelatore: 35 mm
- Dotato di cartuccia in ceramica
- Flessibili da 450 mm con dado da 3/8" per una facile installazione
- Rompigetto brevettato per una marcata riduzione dei depositi di calcare
- Contropiastra di rinforzo per una maggiore stabilità
- Certificato LGA e DVGW



## BLANCO LARESSA-F

- Con un solo gesto, BLANCO LARESSA-F si piega in avanti per consentire l'apertura della finestra
- Leva comandi a destra per lavelli con vasca a sinistra
- Leva comandi a sinistra per lavelli con vasca a destra



Dettagli Colore / Finitura	Codice	Euro
Cromato - Leva comandi a DX	1521545	505,00
Cromato - Leva comandi a SX	1521546	505,00

**N.B.:** Altezza minima tra lavello e finestra: 6,5 cm

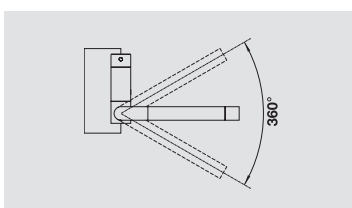
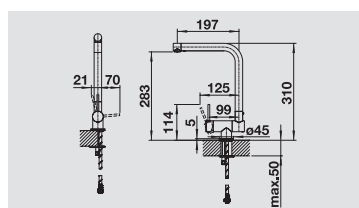

- Miscelatore pieghevole
- Girevole sino a 360°
- Diametro foro per miscelatore: 35 mm
- Dotato di cartuccia in ceramica
- Flessibili da 500 mm con dado da 3/8" per una facile installazione
- Rompigetto brevettato per una marcata riduzione dei depositi di calcare
- Contropiastra di rinforzo per una maggiore stabilità
- Certificato LGA e DVGW



## BLANCO DARAS-F

- Miscelatore per installazione sottofinestra
- Funzionamento semplicissimo: si solleva e si ripone a lato
- Adatto ai lavelli di dimensioni ridotte



Dettagli Colore / Finitura	Codice	Euro
Cromato	1521751	255,00

**N.B.:** Altezza minima tra lavello e finestra: 3 cm.

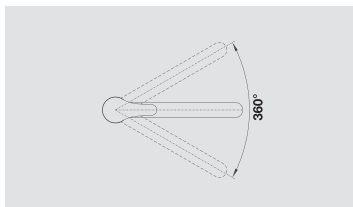
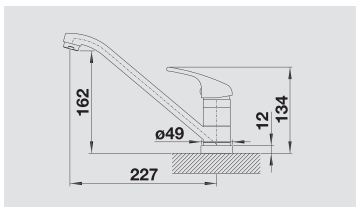

- Miscelatore abbattibile
- Girevole sino a 360°
- Diametro foro per miscelatore: 35 mm
- Dotato di cartuccia in ceramica
- Flessibili da 750 mm con dado da 3/8" per una facile installazione



## BLANCO DARAS-S-F

- Miscelatore per installazione sottofinestra
- Funzionamento semplicissimo: si solleva e si ripone a lato
- Adatto ai lavelli di dimensioni ridotte
- Dotato di doccetta estraibile



Dettagli Colore / Finitura	Codice	Euro
Cromato	1521752	408,00

**N.B.:** Altezza minima tra lavello e finestra: 4 cm.

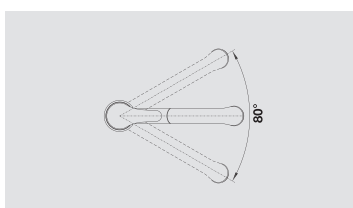
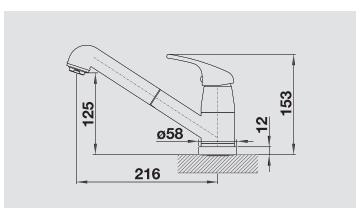

- Miscelatore abbattibile
- Girevole sino a 80°
- Diametro foro per miscelatore: 35 mm
- Dotato di cartuccia in ceramica
- Flessibili da 750 mm con dado da 3/8" per una facile installazione
- Dotato di valvola di non-ritorno certificata EN 1717



# Dispenser di sapone BLANCO YANO BLANCO TIGA BLANCO TANGO BLANCO PIONA

- Facile ricarica dall'alto
- Massima funzionalità
- È necessario un foro aggiuntivo da 35 mm di diametro

Per il corretto funzionamento, i dispenser vanno riempiti con il 50% di acqua e il 50% di sapone liquido.

Dispenser BLANCO YANO	Dettagli / Finitura	Codice	Euro	dimensioni in mm
	Cromato Capacità: 300 ml	1524256	63,00	
Dispenser BLANCO TIGA	Dettagli / Finitura	Codice	Euro	dimensioni in mm
	Cromato Capacità: 250 ml	1510769	68,00	
Dispenser BLANCO TANGO	Dettagli / Finitura	Codice	Euro	dimensioni in mm
	Cromato Capacità: 300 ml	1511266	147,00	
Dispenser BLANCO PIONA	Dettagli / Finitura	Codice	Euro	dimensioni in mm
	Cromato Acciaio Massiccio Satinato Opaco Capacità: 500 ml	1517667 1515992	335,00 482,00	

PER IL CORRETTO FUNZIONAMENTO DI TUTTI I DISPENSER, PREMERE LA PARTE PIATTA SUPERIORE  
(NON PREMERE SUL BECCUCCIO)!

Non è possibile l'installazione dei dispenser di sapone dietro il troppopieno dei lavelli con fascia miscelatore (-IF/A)





## Dispenser di sapone BLANCO TORRE

- Facile ricarica dall'alto
- Massima funzionalità
- È necessario un foro addizionale da 35 mm di diametro

Per il corretto funzionamento, i dispenser vanno riempiti con il 50% di acqua e il 50% di sapone liquido.

Dispenser BLANCO TORRE	Dettagli / Finitura	Codice	Euro
	Cromato	1512593	181,00
	Effetto Inox	1512594	222,00
Capacità: 300 ml			

dimensioni  
in mm

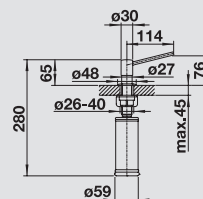

PER IL CORRETTO FUNZIONAMENTO DI TUTTI I DISPENSER, PREMERE LA PARTE PIATTA SUPERIORE  
(NON PREMERE SUL BECCUCCIO)!

Non è possibile l'installazione dei dispenser di sapone dietro il troppopieno dei lavelli con fascia miscelatore (-IF/A)

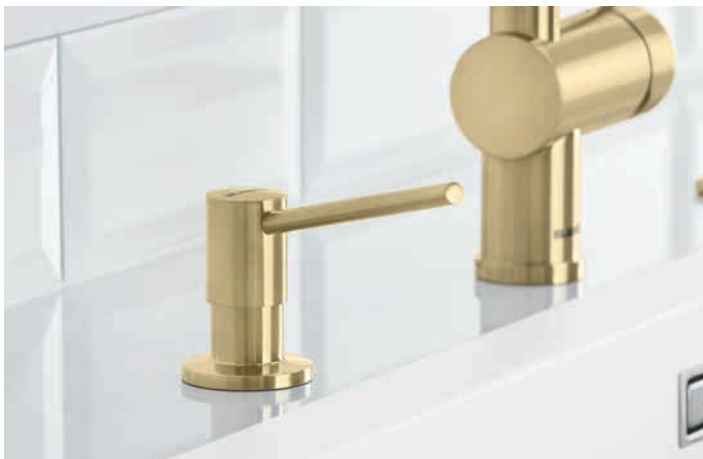

## Dispenser di sapone BLANCO TORRE Satin Gold

**NUOVO**

- Facile ricarica dall'alto
- Massima funzionalità
- È necessario un foro addizionale da 35 mm di diametro

Per il corretto funzionamento, i dispenser vanno riempiti con il 50% di acqua e il 50% di sapone liquido.

Dispenser BLANCO TORRE Satin Gold	Dettagli / Finitura	Codice	Euro
	PVD Satin Gold	1526700	222,00
	Capacità: 300 ml		

dimensioni  
in mm

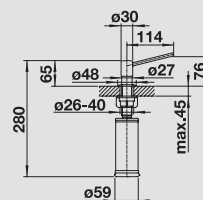

PER IL CORRETTO FUNZIONAMENTO DI TUTTI I DISPENSER, PREMERE LA PARTE PIATTA SUPERIORE  
(NON PREMERE SUL BECCUCCIO)!

Non è possibile l'installazione dei dispenser di sapone dietro il troppopieno dei lavelli con fascia miscelatore (-IF/A)

MISCELATORI



## Dispenser di sapone BLANCO LIVIA

- Facile ricarica dall'alto
- Massima funzionalità
- È necessario un foro aggiuntivo da 35 mm di diametro
- Perfetto abbinamento con il miscelatore e il comando saltarello della stessa serie

Per il corretto funzionamento, i dispenser vanno riempiti con il 50% di acqua e il 50% di sapone liquido.

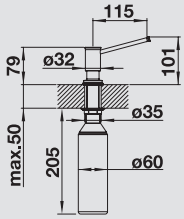
Dispenser BLANCO LIVIA	Dettagli / Finitura	Codice	Euro	dimensioni in mm
	Cromato	1521291	289,00	
	Grigio manganese	1521293	448,00	
	Capacità: 500 ml			
<p>PER IL CORRETTO FUNZIONAMENTO DI TUTTI I DISPENSER, PREMERE LA PARTE PIATTA SUPERIORE (NON PREMERE SUL BECCUCCIO)!</p> <hr/> <p>Non è possibile l'installazione dei dispenser di sapone dietro il troppopieno dei lavelli con fascia miscelatore (-IF/A)</p>				



## Dispenser di sapone BLANCO LIVIA Satin Gold

**NUOVO**

- Facile ricarica dall'alto
- Massima funzionalità
- È necessario un foro aggiuntivo da 35 mm di diametro
- Perfetto abbinamento con il miscelatore e il comando saltarello della stessa serie

Per il corretto funzionamento, i dispenser vanno riempiti con il 50% di acqua e il 50% di sapone liquido.

Dispenser BLANCO LIVIA Satin Gold	Dettagli / Finitura	Codice	Euro	dimensioni in mm
	PVD Satin Gold	1526698	408,00	
	Capacità: 500 ml			
<p>PER IL CORRETTO FUNZIONAMENTO DI TUTTI I DISPENSER, PREMERE LA PARTE PIATTA SUPERIORE (NON PREMERE SUL BECCUCCIO)!</p> <hr/> <p>Non è possibile l'installazione dei dispenser di sapone dietro il troppopieno dei lavelli con fascia miscelatore (-IF/A)</p>				



## Dispenser di sapone BLANCO LATO Nero Opaco

- Dispenser di sapone dal design moderno
- Elegante finitura nera opaca in linea con i trend attuali
- Funzionamento semplice e dosaggio preciso
- Dimensioni ridotte
- Facile ricarica dall'alto
- Perfetto abbinamento con gli altri prodotti in Nero Opaco

Per il corretto funzionamento, i dispenser vanno riempiti con il 50% di acqua e il 50% di sapone liquido.

Dispenser BLANCO LATO	Dettagli Colore / Finitura	Codice	Euro
--------------------------	-------------------------------	--------	------



Nero Opaco

1525789

176,00

dimensioni  
in mm

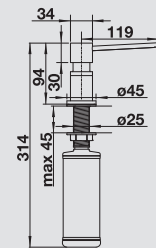

Ø foro intaglio:  
min. 27 mm  
max 35 mm

PER IL CORRETTO FUNZIONAMENTO DI TUTTI I DISPENSER, PREMERE LA PARTE PIATTA SUPERIORE  
(NON PREMERE SUL BECCUCCIO)!

Non è possibile l'installazione dei dispenser di sapone dietro il troppopieno dei lavelli con fascia miscelatore (-IF/A)



## Dispenser di sapone BLANCO LATO

- Dispenser di sapone per piatti dal design moderno
- Funzionamento semplice e dosaggio preciso
- Dimensioni ridotte
- Facile ricarica dall'alto
- Disponibile nella versione cromata e nella finitura PVD Steel
- Disponibile anche nei colori SILGRANIT (v. pag. 242)

Per il corretto funzionamento, i dispenser vanno riempiti con il 50% di acqua e il 50% di sapone liquido.

Dispenser BLANCO LATO	Dettagli Colore / Finitura	Codice	Euro
--------------------------	-------------------------------	--------	------



Cromato  
Finitura PVD Steel

1525808

142,00

1525809

164,00

dimensioni  
in mm

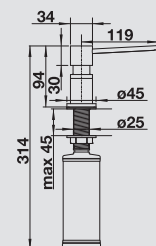

Ø foro intaglio:  
min. 27 mm  
max 35 mm

PER IL CORRETTO FUNZIONAMENTO DI TUTTI I DISPENSER, PREMERE LA PARTE PIATTA SUPERIORE  
(NON PREMERE SUL BECCUCCIO)!

Non è possibile l'installazione dei dispenser di sapone dietro il troppopieno dei lavelli con fascia miscelatore (-IF/A)



## Dispenser di sapone BLANCO LATO Satin Gold

**NUOVO**

- Dispenser di sapone dal design moderno
- Funzionamento semplice e dosaggio preciso
- Dimensioni ridotte
- Facile ricarica dall'alto
- Perfetto abbinamento con gli altri prodotti nella medesima finitura

Per il corretto funzionamento, i dispenser vanno riempiti con il 50% di acqua e il 50% di sapone liquido.

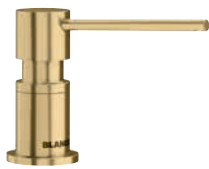
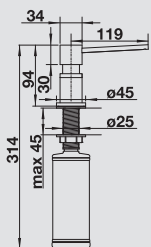
Dispenser BLANCO LATO	Dettagli Colore / Finitura	Codice	Euro	dimensioni in mm
	PVD Satin Gold	1526699	164,00	

PER IL CORRETTO FUNZIONAMENTO DI TUTTI I DISPENSER, PREMERE LA PARTE PIATTA SUPERIORE  
(NON PREMERE SUL BECCUCCIO)!

Non è possibile l'installazione dei dispenser di sapone dietro il troppopieno dei lavelli con fascia miscelatore (-IF/A)

Ø foro intaglio:  
min. 27 mm  
max 35 mm



## Dispenser di sapone BLANCO LATO

- Dispenser di sapone per piatti dal design moderno
- Funzionamento semplice e dosaggio preciso
- Dimensioni ridotte
- Facile ricarica dall'alto
- Disponibile nei colori Silgranit/cromato per un perfetto abbinamento coi lavelli e i miscelatori Silgranit

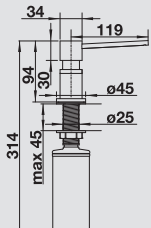
Dispenser BLANCO LATO	Dettagli Colore / Finitura	Codice	Euro	dimensioni in mm
	Cromato/Nero Cromato/Antracite Cromato/Grigio Roccia Cromato/Alumetallic Cromato/Grigio Vulcano Cromato/Bianco Cromato/Soft White Cromato/Tartufo Cromato/Caffè	1526177 1525810 1525817 1525811 1526954 1525814 1526955 1525816 1525815	159,00 159,00 159,00 159,00 159,00 159,00 159,00 159,00 159,00	

PER IL CORRETTO FUNZIONAMENTO DI TUTTI I DISPENSER, PREMERE LA PARTE PIATTA SUPERIORE  
(NON PREMERE SUL BECCUCCIO)!

Non è possibile l'installazione dei dispenser di sapone dietro il troppopieno dei lavelli con fascia miscelatore (-IF/A)

Ø foro intaglio:  
min. 27 mm  
max 35 mm





## Comando saltarello BLANCO COMFORT

Nero Opaco

- Comando a saltarello COMFORT
- Elegante finitura nera opaca
- Adatto per scarico InFino® e scarico standard
- Abbinamento ideale con miscelatori e dispenser della stessa finitura

Comando saltarello  
BLANCO COMFORT

Dettagli  
Colore / Finitura

Codice

Euro

dimensioni  
in mm



Nero Opaco

1238688

181,00

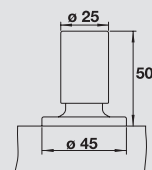

Ø foro intaglio:  
min. 14 mm  
max 35 mm



## Comando saltarello BLANCO COMFORT

- Funzionante anche con il nuovo sistema InFino
- Disponibile in 6 differenti versioni

Comando saltarello  
BLANCO COMFORT

Dettagli / Finitura

Codice

Euro

dimensioni  
in mm



Materiale sintetico cromato  
Cromato  
Effetto Inox  
Acciaio Satinato Opaco  
Acciaio Satinato Lucido  
Acciaio Spazzolato

1225112 74,00  
1221339 125,00  
1221336 142,00  
1222118 181,00  
1222115 181,00  
1226540 181,00

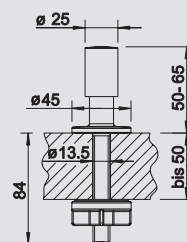

Ø foro intaglio:  
min. 14 mm  
max 35 mm



## Comando saltarello BLANCO LIVIA

- Adatto al sistema InFino e standard
- Ideale abbinamento con il miscelatore e il dispenser di sapone della stessa finitura

Comando saltarello BLANCO LIVIA	Dettagli / Finitura	Codice	Euro	dimensioni in mm
	Cromato	1521294	125,00	 <p>Ø foro intaglio: min. 14 mm max 35 mm</p>
	Ottone Satinato	1521295	171,00	
	Grigio Manganese	1521296	232,00	



## Comando saltarello BLANCO LIVIA Satin Gold

**NUOVO**

- Adatto al sistema InFino e standard
- Ideale abbinamento con il miscelatore e il dispenser di sapone della stessa finitura

Comando saltarello BLANCO LIVIA	Dettagli / Finitura	Codice	Euro	dimensioni in mm
	PVD Satin Gold	1526701	205,00	 <p>Ø foro intaglio: min. 14 mm max 35 mm</p>

# RACCOGLIERE, SEPARARE, METTERE IN ORDINE.

I sistemi per la raccolta differenziata di BLANCO



La base sottolavello gioca un ruolo importante nella progettazione della cucina. È il posto in cui si raccolgono i rifiuti, si conservano i prodotti per la pulizia e che è spesso limitato nello spazio a causa dei tubi di scarico, una caldaia o un filtro. Qui in particolare è importante disporre di un sistema di raccolta differenziata, che sfrutti in modo ottimale lo spazio e possa adattarsi alle esigenze più specifiche.

BLANCO offre il sistema giusto per la maggior parte delle basi sottolavello e per le ante estraibili. Se lo spazio nel mobile base è limitato, le nostre soluzioni come SELECT II o FLEXON II Low offrono la massima versatilità e flessibilità.



Una raccolta differenziata ben organizzata significa ordine e pulizia in cucina e contribuisce all'ambiente.



I sistemi di raccolta differenziata BLANCO soddisfano le esigenze di praticità e design e sono adatti a tutte le cucine.



I sistemi BLANCO per la raccolta differenziata scompaiono elegantemente nella base sottolavello. Che l'anta sia scorrevole o con cerniera, c'è sempre una soluzione per qualsiasi esigenza.



# BLANCO SELECT II Orga

**NUOVO**







- Sistemi con guida, per ante estraibili
- Utilizzo ottimale dello spazio nella base sottolavello
- Vasta gamma di soluzioni per dimensioni delle basi
- Massima flessibilità nella separazione e suddivisione dei contenitori
- Cassetto superiore scorrevole in dotazione per una migliore organizzazione degli strumenti di uso quotidiano
- Design moderno in alluminio di alta qualità
- Altezza installazione 456 mm, profondità d'installazione 400 mm, richiesta dimensione interna del mobile di 450 mm

BLANCO SELECT II 60/2 Orga	Codice	Euro	60 cm Misura del mobile	
  <p><b>Incluso in fornitura:</b> cassetto superiore scorrevole</p>	1526208	686,00	12 L  49 L 	
BLANCO SELECT II 60/3 Orga	Codice	Euro	60 cm Misura del mobile	
  <p><b>Incluso in fornitura:</b> cassetto superiore scorrevole</p>	1526209	703,00	12 L  45 L 	
BLANCO SELECT II XL 60/3 Orga	Codice	Euro	60 cm Misura del mobile	
  <p><b>Incluso in fornitura:</b> cassetto superiore scorrevole e coperchio per un contenitore da 8 L</p>	1526210	726,00	12 L  46 L 	
BLANCO SELECT II 60/4 Orga	Codice	Euro	60 cm Misura del mobile	
  <p><b>Incluso in fornitura:</b> cassetto superiore scorrevole e coperchio per un contenitore da 6 L</p>	1526211	738,00	12 L  42 L 	

### PER TUTTI I MODELLI BLANCO SELECT II, SELECT II Orga:

- Le ante non devono avere cerniere o fori. Tenere in considerazione la posizione della maniglia.
- Può essere installato anche in mobili con ante telaio da 40 mm, di peso non superiore ai 10 Kg; portata massima, anta inclusa: 45 Kg.
- Adatte per fianchi di spessore di 16, 18 e 19 mm.
- In fase di progettazione, considerare l'altezza del sistema di raccolta differenziata, la profondità del lavello e il conseguente spazio utile disponibile nella base sottolavello.
- Altezza minima dello zoccolino per l'installazione di MOVEX: 100 mm

### Accessori opzionali

BLANCO SELECT Automove	BLANCO SELECT Clip	Protezione flessibile per i flessibili miscelatore	Coperchio per contenitore da 15 L	Universalbox	BLANCO MOVEX Controllo a piede per SELECT II
					
Cod. 1521301 Euro 851,00	Cod. 1521300 Euro 74,00	Cod. 1511920 Euro 51,00	Cod. 1229338 Euro 51,00	Cod. 1229342 Euro 46,00	Cod. 1519357 Euro 51,00



# BLANCO SELECT II

**NUOVO**

- Sistemi con guida, per ante estraibili
- Utilizzo ottimale dello spazio nella base sottolavello
- Vasta gamma di soluzioni per dimensioni delle basi
- Massima flessibilità nella separazione e suddivisione dei contenitori
- “Frame Bar” disponibile come accessorio per personalizzare il numero dei contenitori (v. pag. 257) in dotazione di serie per i modelli XL 60/3 e 60/4
- Design moderno in alluminio di alta qualità
- Altezza installazione 361 mm, profondità d’installazione 400 mm, richiesta dimensione interna del mobile di 450 mm
- Ulteriori dettagli per l’installazione a pag. 247



BLANCO SELECT II 45/2	Codice	Euro	45 cm Misura del mobile
 	1526200	482,00	32 L  
BLANCO SELECT II 60/2	Codice	Euro	60 cm Misura del mobile
 	1526203	522,00	49 L  
BLANCO SELECT II 60/3	Codice	Euro	60 cm Misura del mobile
 	1526204	533,00	45 L  
BLANCO SELECT II XL 60/3	Codice	Euro	60 cm Misura del mobile
  <b>Incluso in fornitura:</b> coperchio per contenitore da 8 L e “Frame Box”	1526205	545,00	46 L  
BLANCO SELECT II 60/4	Codice	Euro	60 cm Misura del mobile
  <b>Incluso in fornitura:</b> coperchio per contenitore da 6 L e “Frame Box”	1526206	572,00	42 L  

## Accessori opzionali

**BLANCO SELECT Automove**



Cod. 1521301  
Euro 851,00

**BLANCO SELECT Clip**



Cod. 1521300  
Euro 74,00

**Protezione flessibile per i flessibili miscelatore**



Cod. 1511920  
Euro 51,00

**Coperchio per contenitore da 15 L**



Cod. 1229338  
Euro 51,00

**Universalbox**



Cod. 1229342  
Euro 46,00

**BLANCO MOVEX Apertura a piede per SELECT II**



Cod. 1519357  
Euro 51,00

# RACCOGLIERE, SEPARARE, METTERE IN ORDINE.

BLANCO FLEXON II - il massimo dallo spazio sotto al lavello



La famiglia BLANCO FLEXON II offre contenitori per rifiuti con un telaio di alta qualità, è facile da installare nei cestoni estraibili standard. Grazie all'ampia scelta di modelli con cestini di diverse dimensioni, FLEXON II offre la massima libertà di progettazione. Indipendentemente dal fatto che il mobile sia largo 30 o 90 cm, con cassetti singoli o divisi, BLANCO FLEXON II può essere facilmente adattato ai cassetti della cucina esistenti. Il telaio è posizionato nel cassetto, rendendo i cestini facilmente accessibili ed estremamente facili da pulire.

Ma FLEXON II offre molto di più: la versione Low può essere installata direttamente sotto il piano di lavoro. Questo per garantire la massima ergonomia. BLANCO FLEXON II è inoltre perfettamente adatto anche per riporre spugne, detersivi, etc.



FLEXON II Low sfrutta al massimo lo spazio del mobile sottolavello inserendo rifiuti e materiali riciclabili direttamente sotto il piano di lavoro o il lavello.



FLEXON II Low è la soluzione perfetta per la raccolta differenziata e anche per riporre spugne, detersivi, etc.



Ideale per i cassetti esistenti: si inserisce perfettamente in cassetti da 30 a 60 cm di larghezza.







# BLANCO FLEXON II

- Il telaio viene semplicemente fissato al cestone estraibile
- Facile accesso per agevolare la pulizia del sistema
- Il bordo dei contenitori inclinato verso l'interno impedisce il deposito di residui di rifiuti
- Il ripiano estraibile funge da coperchio per i contenitori
- Altezza installazione 355 mm dalla base del cestone (325 mm senza ripiano), profondità d'installazione 400 mm, altezza massima del telaio 250 mm
- Accessori alle pagg. 254-255



reddot award  
winner

BLANCO FLEXON II 30/1	Codice	Euro	30 cm Misura del mobile
 	1521542	222,00	19 L  
BLANCO FLEXON II 30/2	Codice	Euro	30 cm Misura del mobile
  <p>Incluso in fornitura: 1 coperchio per contenitore da 8 L</p>	1521467	249,00	16 L  
BLANCO FLEXON II 45/2	Codice	Euro	45 cm Misura del mobile
 	1521468	255,00	32 L  







# BLANCO FLEXON II

- Il telaio viene semplicemente fissato al cestone estraibile
- Facile accesso per agevolare la pulizia del sistema
- Il bordo dei contenitori inclinato verso l'interno impedisce il deposito di residui di rifiuti
- Il ripiano estraibile funge da coperchio per i contenitori
- Altezza installazione 355 mm dalla base del cestone (325 mm senza ripiano), profondità d'installazione 400 mm, altezza massima del telaio 250 mm
- Accessori alle pagg. 254-255



reddot award  
winner

BLANCO FLEXON II 60/2	Codice	Euro	60 cm Misura del mobile
 	1521471	295,00	49 L  
BLANCO FLEXON II 60/3	Codice	Euro	60 cm Misura del mobile
 	1521472	312,00	45 L  
BLANCO FLEXON II XL 60/3	Codice	Euro	60 cm Misura del mobile
 	1521473	335,00	46 L  
<b>Coperchio per 1 contenitore da 8 L incluso nella fornitura.</b>			
BLANCO FLEXON II 60/4	Codice	Euro	60 cm Misura del mobile
 	1521474	357,00	42 L  

## Accessori opzionali

BLANCO  
SELECT Clip



Cod. 1521300  
Euro 74,00

Universalbox



Cod. 1229342  
Euro 46,00

Coperchio  
per contenitore da 15 L



Cod. 1229338  
Euro 51,00



# BLANCO FLEXON II Low

**NUOVO**



- Il telaio viene semplicemente fissato al cestone estraibile
- Facile accesso per agevolare la pulizia del sistema
- Il bordo dei contenitori inclinato verso l'interno impedisce il deposito di residui di rifiuti
- Installazione semplice senza marcatura o preforatura
- Design moderno con alluminio di alta qualità
- Gli accessori opzionali migliorano il sistema per creare una soluzione individuale
- Altezza installazione 325 mm dalla base del cestone (325 mm senza ripiano), profondità d'installazione 400 mm, altezza massima del telaio 250 mm

BLANCO FLEXON II Low	Codice	Euro	60 cm
60/2			Misura del mobile
 	1526641	222,00	49 L 
			
BLANCO FLEXON II Low	Codice	Euro	60 cm
60/3			Misura del mobile
 	1526642	239,00	45 L 
			
BLANCO FLEXON II Low	Codice	Euro	60 cm
XL 60/3			Misura del mobile
 	1526643	266,00	46 L 
			
BLANCO FLEXON II Low	Codice	Euro	60 cm
60/4			Misura del mobile
 	1526644	284,00	42 L 
			
BLANCO FLEXON II Low	Codice	Euro	90 cm
90/4			Misura del mobile
 	1521475	379,00	73 L 
			

Ripiano estraibile non disponibile.

## Accessori opzionali

BLANCO SELECT Clip



Cod. 1521300  
Euro 74,00

Universalbox



Cod. 1229342  
Euro 46,00

Coperchio per contenitore da 15 L





Cod. 1229338  
Euro 51,00



## BLANCO BOTTON Pro Manuale

- Installazione sul fondo della base sottolavello semplice e veloce
- Migliore rapporto prezzo/performance
- Perfetto connubio di design e solidità
- Guide completamente estensibili montate su cuscinetti a sfera
- Maniglia funzionale, per una maggiore maneggevolezza
- Ottimizzazione dello spazio per basi sottolavello da 45 e 60 cm
- Facili da pulire, i contenitori sono dotati di maniglia ergonomica
- Grande capacità di raccolta (26 l - 39 l)

BLANCO BOTTON Pro 45/2 Manuale	Codice	Euro	45 cm Misura del mobile	
 	1517467	210,00	26 L	
BLANCO BOTTON Pro 60/3 Manuale	Codice	Euro	60 cm Misura del mobile	
 	1517469	266,00	39 L	





### Note per l'installazione di BLANCO BOTTON Pro Manuale:

- Considerare la larghezza della cerniera delle antine
- Profondità di installazione 400 mm
- Altezza di installazione 350 mm



# BLANCO BOTTON Pro Automatica

- Installazione sul fondo della base sottolavello semplice e veloce
- Migliore rapporto prezzo/performance
- Estrazione dei contenitori a traino dell'anta
- Guide completamente estensibili montate su cuscinetti a sfera
- Ottimizzazione dello spazio per basi sottolavello da 45 e 60 cm
- Facile da pulire, i secchi sono dotati di maniglia ergonomica
- Grande capacità (26 l - 39 l)

BLANCO BOTTON Pro 45/2 Automatica	Codice	Euro	45 cm Misura del mobile	
 	1517468	255,00	26 L	
BLANCO BOTTON Pro 60/3 Automatica	Codice	Euro	60 cm Misura del mobile	
 	1517470	312,00	39 L	



## Note per l'installazione di BLANCO BOTTON Pro Automatica:

- Utilizzare antine con apertura min. di 100°.
- Considerare la larghezza della cerniera delle antine (massimo 35 mm).
- Profondità di installazione 400 mm
- Altezza di installazione 350 mm



# BLANCO SOLON-IF

## Soluzione integrata nel piano di lavoro

- Permette di lavorare direttamente nel contenitore
- Completamente in acciaio inox di alta qualità e facile da pulire
- Evita di doversi chinare verso i contenitori sottostanti
- Riempimento del contenitore direttamente dal piano di lavoro
- Igiene e solidità grazie al contenitore in acciaio inox
- Per installazione sopratop e a filotop

Tipologia  
di incasso:



BLANCO SOLON	Codice	Euro	30 cm Misura del mobile
--------------	--------	------	----------------------------



Montaggio a filotop/sopratop    1512471    1.129,00

**Incluso in fornitura:** 1 contenitore da 20 l, coperchio

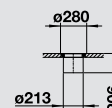



# BLANCO SINGOLO XL

**NUOVO**

- Sistema compatto per installazione sull'anta del mobile
- Grande capacità per rifiuti
- Si apre comodamente aprendo l'anta del mobile
- Il cestino interno può essere facilmente rimosso sollevandolo verso l'alto
- Stabile e duraturo grazie al corpo in acciaio
- Può essere montato sia sul lato sinistro, sia sul lato destro



BLANCO SINGOLO XL

Codice Euro

1526377 181,00

**40 cm**  
Misura del mobile



**Incluso in fornitura:** 1 contenitore da 20 l, coperchio

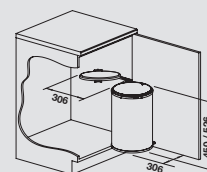

# Accessori per i sistemi BLANCO per la raccolta differenziata

## BLANCO SELECT Clip

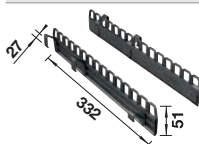

- Sistema di aggancio del sacchetto facile e sicuro
- Adatto per tutti i contenitori BLANCO SELECT II e FLEXON II a partire da 15 Lt e ogni misura di sacchetto
- Soluzione per ottimizzare la capacità e l'utilizzo dei contenitori SELECT II e FLEXON II

	Codice	Euro
	1521300	74,00

## BLANCO SELECT AutoMove



- Delicato supporto per l'apertura delle ante estraibili, con il tocco di un dito
- Maggiore libertà: ottima soluzione anche per ante senza maniglie
- Installazione facile e veloce
- Raccomandato scarico con il sifone di tipo salva spazio
- Non adatto ad ante con guarnizione perimetrale

	Codice	Euro
	1521301	851,00

## BLANCO Movex



- Soluzione semplice e pratica per l'apertura frontale degli sportelli. Inserito alla base dell'anta, ne permette l'apertura col piede
- Il montaggio è semplice grazie alla dima, non richiede modifiche del mobile
- Esclusivo rivestimento in acciaio inox

	Codice	Euro
	1519357	51,00

# Accessori per i sistemi BLANCO per la raccolta differenziata

## Universal box



- Adatto ai contenitori da 8 L, 15 L o 19 L
- Ideale anche per la raccolta dell'umido
- Lavabile in lavastoviglie
- Incluso nel modello BLANCO SELECT Orga





	Codice	Euro
	1229342	46,00

## Coperchi per contenitori SELECT II e FLEXON II



- Coperchi per coprire i contenitori e raccogliere piccoli oggetti
- Perfettamente abbinabile a BLANCO SELECT
- Coperchio per contenitori da 8 L incluso in BLANCO SELECT 50/3, XL 60/3 e XL 60/3 Orga

	Codice	Euro
	Coperchio per contenitore da 15 LT (incluso nei modd. SELECT II e FLEXON II 60/3 e 60/4)	1229338 51,00
	Coperchio per contenitore da 6 LT (incluso nei modd. SELECT II e FLEXON II 60/4)	1231974 46,00
	Coperchio per contenitore da 8 LT (1 pz. incluso nei modd. SELECT II e FLEXON II 30/2, XL 60/3)	1231975 39,00

## Frame Bar per BLANCO SELECT II



- Massima flessibilità per riconfigurare i contenitori dei sistemi BLANCO SELECT II
- Consente una semplice modifica dei contenitori: il mod. 60/2 con due contenitori può diventare un XL 60/3 con tre contenitori

**NUOVO**

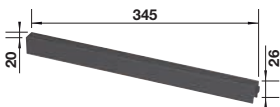
	Codice	Euro
	1239913	34,00

# DISSIPATORI DI RIFIUTI ALIMENTARI BLANCO

NUOVO

Igienici, pratici, semplici da usare.



BLANCO UNIT è la soluzione integrata per l'area del lavello. Semplifica il design della cucina e agevola le operazioni quotidiane. Combina miscelatore, lavello e accessori adattandosi a qualsiasi stile, qualsiasi spazio e qualsiasi esigenza. BLANCO ha ora aggiunto i dissipatori di rifiuti alimentari alla sua gamma di prodotti, in modo da poter creare una soluzione completa da un'unico fornitore, con la qualità BLANCO che i clienti conoscono e amano. Tutti e tre i modelli FWD sono perfettamente progettati per adattarsi ai lavelli e alle vasche BLANCO, includono un potente motore a induzione CA di alta qualità, sono semplici da installare e la camera interna di dissipazione è in acciaio inossidabile. Creare una cucina perfettamente coordinata con flussi di lavoro fluidi è sempre stato semplice con BLANCO UNIT, e da oggi puoi anche aggiungere la dissipazione dei rifiuti alimentari, rendendone la gestione un'esperienza facile, igienica e conveniente.



La nostra gamma di dissipatori BLANCO FWD, Lite, Medium e Max, si adatta a tutti i lavelli e alle vasche BLANCO.



Il comodo pulsante pneumatico può essere installato sulla fascia miscelatore del lavello, oppure sul piano di lavoro.



FWD Lite



FWD Medium



FWD Max





# BLANCO FWD Max

**NUOVO**

- Modello più avanzato, adatto per nuclei familiari medi
- Potente motore a induzione CA
- Installazione semplificata grazie al sistema con 3 sole viti di fissaggio
- Componenti della camera di dissipazione in acciaio inox
- 3 fasi di dissipazione per la riduzione in particelle extra fini
- Capacità della camera di dissipazione: 1200 ml
- 1 HP/ 230 V/50 Hz/ 12 A

CE



DESIGN  
AWARD  
2022



BLANCO FWD Max  
Motore a induzione CA

**NUOVO**

Dissipatore FWD Max

Codice

Euro

1526648

1.248,00

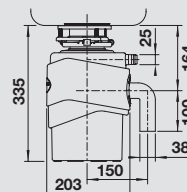

## Inclusi in fornitura



Set pulsante pneumatico



Ghiera per pulsante pneumatico



Guarnizione in gomma



Tappo a cestello



Connessione troppopieno



Chiave a brugola



Tubazione di scarico a gomito

- Diaframma antispruzzo removibile
- Tappo per la chiusura dello scarico
- Interruttore pneumatico cromato e in finitura PVD Steel
- Tubazione a gomito per collegamento del troppopieno e della lavastoviglie
- Chiave a brugola di sbloccaggio
- Adatto a vasche con scarico da 3 1/2" di diametro
- Peso netto: 11 kg
- Cavo di connessione elettrica da 90 cm con spina schuko
- Spegnimento automatico di protezione dopo 10 min.
- Tasto di ripristino sul fondo del dissipatore
- Rumorosità: < 60dB
- Assorbimento: 750 W

## Accessori opzionali

Ghiera in SATIN GOLD  
per pulsante pneumatico



Cod. 1526769  
Euro 46,00

Ghiera in NERO OPACO  
per pulsante pneumatico



Cod. 1526770  
Euro 46,00

Kit di collegamento  
per la seconda vasca



Cod. 1526772  
Euro 46,00

**NUOVO**

# BLANCO FWD Medium



- Modello più avanzato, adatto per nuclei familiari medi
- Potente motore a induzione CA
- Installazione semplificata grazie al sistema con 3 sole viti di fissaggio
- Componenti della camera di dissipazione in acciaio inox
- 3 fasi di dissipazione per la riduzione in particelle extra fini
- Capacità della camera di dissipazione: 1200 ml
- 3/4 HP/ 230 V/50 Hz/ 12 A



**BLANCO FWD Medium**  
Motore a induzione CA

**NUOVO**

Dissipatore FWD Medium

Codice

Euro

1526647

965,00

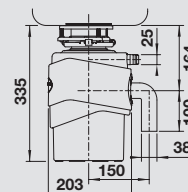

## Inclusi in fornitura



Set pulsante pneumatico



Ghiera per pulsante pneumatico



Guarnizione in gomma



Tappo a cestello



Connessione troppopieno



Chiave a brugola



Tubazione di scarico a gomito

- Diaframma antispruzzo removibile
- Tappo per la chiusura dello scarico
- Interruttore pneumatico cromato e in finitura PVD Steel
- Tubazione a gomito per collegamento del troppopieno e della lavastoviglie
- Chiave a brugola di sbloccaggio
- Adatto a vasche con scarico da 3 1/2" di diametro
- Peso netto: 10,6 kg
- Cavo di connessione elettrica da 90 cm con spina schuko
- Spegnimento automatico di protezione dopo 25 min.
- Tasto di ripristino sul fondo del dissipatore
- Rumorosità: < 60/70dB
- Assorbimento: 550 W

## Accessori opzionali

**Ghiera in SATIN GOLD**  
per pulsante pneumatico



Cod. 1526769  
Euro 46,00

**Ghiera in NERO OPACO**  
per pulsante pneumatico



Cod. 1526770  
Euro 46,00

**Kit di collegamento**  
per la seconda vasca



Cod. 1526772  
Euro 46,00

# BLANCO FWD Lite **NUOVO**

- Modello base, adatto ai piccoli nuclei familiari
- Potente motore a induzione CA con funzione autoreverse
- Installazione semplificata grazie al sistema con 3 sole viti di fissaggio
- Ripristino sovraccarico manuale a protezione del motore
- Componenti della camera di dissipazione in acciaio inox
- 2 fasi di dissipazione per la riduzione in particelle extra fini
- Capacità della camera di dissipazione: 900 ml
- 0.5 HP/ 230 V/50 Hz/ 10 A



BLANCO FWD Lite  
Motore a induzione CA

**NUOVO**

Dissipatore FWD Lite

Codice

Euro

1526646

642,00

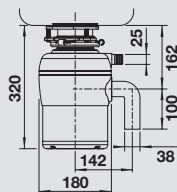

## Inclusi in fornitura



Kit pulsante pneumatico



Diaframma antispruzzo



Tappo



Connessione troppopieno



Chiave a brugola



Tubazione di scarico a gomito

- Diaframma antispruzzo removibile
- Tappo per la chiusura dello scarico
- Interruttore pneumatico cromato
- Tubazione a gomito per collegamento del troppopieno e della lavastoviglie
- Chiave a brugola di sbloccaggio
- Adatto a vasche con scarico da 3 1/2" di diametro
- Peso netto: 7,4 kg
- Cavo di connessione elettrica da 90 cm con spina schuko
- Spegnimento automatico di protezione dopo 25 min.
- Tasto di ripristino sul fondo del dissipatore
- Rumorosità: < 70dB
- Assorbimento: 370 W

## Accessori opzionali

Ghiera in NERO OPACO  
per pulsante pneumatico



Cod. 1526770  
Euro 46,00

Ghiera e tasto PVD STEEL  
per pulsante pneumatico



Cod. 1526768  
Euro 46,00

Ghiera in SATIN GOLD  
per pulsante pneumatico



Cod. 1526769  
Euro 46,00

Kit di collegamento  
per la seconda vasca



Cod. 1526772  
Euro 46,00

# FACILITARE LE OPERAZIONI IN CUCINA

Accessori abbinabili e funzionali per le vasche e i lavelli BLANCO



Un lavello può essere molto di più di un posto in cui preparare il cibo e lavare i piatti. Grazie agli accessori appositamente studiati, si trasforma una postazione di lavoro multifunzionale. Un flusso di lavoro semplificato rende la preparazione del cibo un gioco da ragazzi. Gli accessori offrono un vantaggio aggiuntivo molto pratico, soprattutto nelle cucine di piccole dimensioni.



Le vaschette forate sono un pratico accessorio per ogni lavello. Una volta inserite, possono essere utilizzate per tenere da parte la frutta o verdura risciacquata, o per far scolare piatti e bicchieri.



Un tagliere amplia la superficie di lavoro, e può essere sistemato nel punto più comodo della vasca oppure farlo scorrere lungo bordi.



La griglia in acciaio può essere utilizzata per creare un livello aggiuntivo nella vasca. Ideale per esempio, per far sgocciolare le stoviglie oppure per risciacquare frutta e verdura.





# Accessori per le vasche e i lavelli BLANCO

## Griglia pieghevole in acciaio inox



- Può essere posizionato sul gocciolatoio, sulla vasca e sul piano di lavoro
- Aggiunge versatilità alla zona del lavaggio, per es. quando impiegata come gocciolatoio, sopra o accanto al lavello utilizzata per riempire d'acqua le pentole
- Poiché pieghevole, è facile da riporre

	Codice	Euro
 Per vasche da 400 mm	1238482	181,00
 Per vasche da 420 mm	1238483	193,00

## Vaschetta angolare multifunzione



Vaschetta angolare utile non solo per il lavaggio e il risciacquo di frutta e verdura, ma anche come pratico porta-spugnette, posate e utensili.

- Posizionamento angolare con parete posteriore in gomma per una perfetta aderenza

	Codice	Euro
 Raccomandato per BLANCO DALAGO, METRA e PLEON	1235866	96,00

## Barre multiuso in acciaio inox



Posizionate sul bordo della vasca, le barre in acciaio inox con estremità in gomma antiscivolo formano un "ponte" sopra la vasca, permettendo di lavorare su due livelli.

- In acciaio inox di alta qualità
- Uso pratico e versatile sulla vasca e sul piano di lavoro

	Codice	Euro
 Raccomandato per BLANCO SUBLINE e PLEON in Silgranit®, ANDANO, SUPRA, CLARON, ZEROX	1235906	205,00

# Accessori per le vasche e i lavelli BLANCO

## Griglia in acciaio inox



Posizionata in sospensione nella vasca, la griglia crea un ulteriore livello di lavoro, utile per il risciacquo delle stoviglie, il lavaggio di frutta e verdura, etc.; può essere usata anche come sottopentola.

- Maggiore funzionalità in un piccolo ingombro
- In acciaio inox di alta qualità

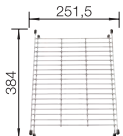
	Codice	Euro
 <p>Raccomandato per BLANCO PLEON e SUBLINE in Silgranit® e ceramica</p>	1234795	205,00

## Capflow



- Elegante copertura per lo scarico
- Lo scarico rimane perfettamente funzionante
- Adatto per tutti i lavelli con scarico da 3 1/2"
- Non compatibile con lo scarico InFino®

	Codice	Euro
	1517666	39,00

## Gocciolatoio in materiale sintetico nero

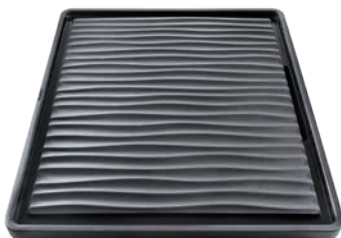

- Design attraente
  - Elevato livello di funzionalità grazie all'eccellente drenaggio e all'appoggio sicuro per le stoviglie
  - Complemento ideale per vasche sottotop e vasche con bordo -IF
- L'acqua gocciola direttamente nella vasca, grazie alla fessura presente sul lato lungo

	Codice	Euro
	1230734	85,00

# Accessori per le vasche e i lavelli BLANCO

## Vassoio sintetico con ripiano forato inox

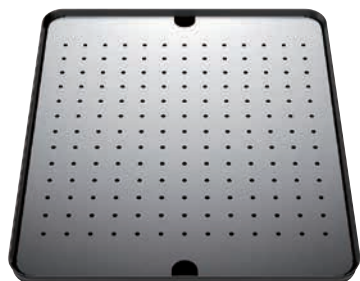

- Posizionato sul piano di lavoro, sostituisce il gocciolatoio
- Ampia superficie per riporre le stoviglie
- Realizzato in materiale sintetico di alta qualità con inserto in acciaio inox
- Ideale in combinazione con vasche singole o doppie

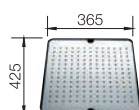

	Codice	Euro
	1513485	253,00

## Cestello inox multifunzione



- Pratica vaschetta supplementare per vasche
- Particolarmente adatto per lavare frutta o verdura
- Adatto a vasche con profondità 400 mm
- Realizzato in acciaio inossidabile di alta qualità e di facile manutenzione

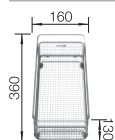

	Codice	Euro
	1223297	215,00

## Cestello inox con griglia per piatti



- Può essere posizionato sia nella vasca, sia sul gocciolatoio e sul piano di lavoro
- Con griglia per piatti (removibile)
- In acciaio inox di alta qualità

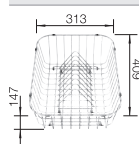

	Codice	Euro
	1507829	239,00

# Accessori per le vasche e i lavelli BLANCO

## Vaschette multifunzione



- Il complemento perfetto per vasche e lavelli
- Per lavare e preparare la frutta e la verdura
- Realizzate in acciaio di alta qualità, facile da mantenere pulito

	Codice	Euro
	Raccomandato per BLANCO ETAGON in ceramica, da posizionare sul gradino integrato della vasca	1226189 159,00
	Raccomandato per BLANCO ETAGON e SUBLINE in SILGRANIT da posizionare sulla vasca	1227689 147,00
	Raccomandato per BLANCO ETAGON in acciaio inox, ANDANO e SUPRA da posizionare sulla vasca	1227692 136,00
	Raccomandato per BLANCO ETAGON in acciaio inox, da posizionare sul gradino integrato della vasca	1231396 222,00

## Taglieri per lavelli con installazione sopratop



- Disponibili per vasche e lavelli con il classico incasso sopratop
- Tenuti a lato del lavello, consentono di lavorare senza intralciare le operazioni nello stesso

	Codice	Euro
	Tagliere a ponte in materiale sintetico bianco, per vasche e lavelli con profondità 510 mm	1210521 181,00
	Tagliere a ponte in materiale sintetico bianco, per vasche e lavelli con profondità 500 mm	12177611 142,00
	Tagliere a ponte in legno massello di faggio, per vasche e lavelli con profondità 500 mm	1218313 136,00
	Tagliere in legno massello di faggio, per vasche e lavelli con profondità 510 mm	1225362 181,00



# Accessori per le vasche e i lavelli BLANCO

## Taglieri per lavelli con installazione -U e -IF



- Adatti alle vasche per incasso sottotop -U e per le vasche con bordo piatto -IF (sopratop/filotop)
- I taglieri possono essere posizionati sia sul piano di lavoro, sia all'interno della vasca, aumentandone la funzionalità
- Adatti per vasche con profondità di 400 mm o 396 mm

	Codice	Euro
	Tagliere in cristallo temperato silver Per BLANCO ETAGON-U in acciaio inox e Silgranit, ANDANO, SUPRA, SUBLINE in Silgranit (non adatto ad ANDANO ed ETAGON -IF/A)	1227697 205,00
	Tagliere in cristallo temperato silver Adatto per vasche SUBLINE in ceramica	1227699 205,00
	Tagliere in legno multistrato Adatto per vasche BLANCO ETAGON in acciaio e SILGRANIT, ANDANO, SUPRA, SUBLINE in SILGRANIT	1230700 352,00
	Tagliere in legno massello Adatto per SUBLINE in ceramica	1514544 181,00
	Tagliere in legno di bambù Adatto per ETAGON, SOLIS, ANDANO	1239449 136,00

**NUOVO**

# LA CURA PERFETTA, IN MODO SEMPLICE

Prodotti per la cura e pulizia delle vasche, dei lavelli e dei miscelatori BLANCO



Le superfici dei lavelli e dei miscelatori BLANCO sono resistenti e attrattive. Dovrebbero essere puliti regolarmente per garantire che rimangano così nel tempo. I prodotti per la pulizia e la cura BLANCO CARE ti consentono di raggiungere questo obiettivo. I prodotti sono facili da usare e sono stati formulati appositamente per le superfici BLANCO. I materiali BLANCO sono stati sottoposti a test intensivi da parte del nostro dipartimento di ricerca e sviluppo.



DailyClean+ è l'anticalcare professionale per tutte le vasche, i lavelli e i miscelatori BLANCO.



Il panno in microfibra è adatto a ogni superficie BLANCO.

# BLANCO CARE. Prodotti per la cura e manutenzione

## DailyClean+



- Anticalcare professionale per tutte le superfici di lavelli e miscelatori.
- Delicato, adatto per l'uso quotidiano.
- Non utilizzare su superfici sensibili agli acidi. Seguire le istruzioni per la cura del produttore.
- In caso di dubbio, testare il prodotto preventivamente su una piccola superficie nascosta.

**NUOVO**

	Codice	Euro
	1526305	34,00

## Deep Clean Acciaio Inox



- Per la pulizia profonda dei lavelli in acciaio inox
- Per la rimozione dello sporco più ostinato
- Aiuta a rimuovere piccoli graffi, ruggine e macchie
- Lascia scorrere l'acqua, previene le impronte digitali e lo sporco
- Non adatto per superfici in acciaio inox Durinox, Dark Steel, superfici cromate e miscelatori

**NUOVO**

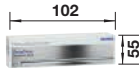
	Codice	Euro
	1526306	51,00

## Deep Clean Ceramica



- Per la pulizia profonda dei lavelli in ceramica
- Per la rimozione dello sporco più ostinato
- Rimuove grasso, macchie di calcare e abrasioni metalliche
- Lucida e mantiene luminosa la superficie

**NUOVO**

	Codice	Euro
	1526308	39,00

## Steel Cleaner Spray



- Detergente speciale per una pulizia profonda delle superfici in acciaio inox
- Rimuove lo sporco ostinato
- Rimuove i depositi di calcare, facilitando la pulizia giornaliera

	Codice	Euro
	1768780	57,00

## Panno in microfibra









- Per la pulizia quotidiana
- Adatto a tutte le superfici

	Codice	Euro
	1126999	63,00

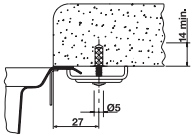
# Accessori per le vasche e i lavelli BLANCO

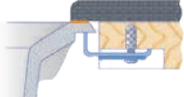





Maggiori informazioni sul sito [www.blanco.com/it](http://www.blanco.com/it) (menu "service", "ricambi e schemi di installazione")

Descrizione	Codice	Euro
 <p><b>Ganci per lavelli inox</b> Per piani di lavoro di spessore ridotto (da 15 a 30 mm)</p>	1223742	15,00
 <p><b>Tappo copriforo</b> di 48 mm di diametro in ottone cromato</p>	1137164	a richiesta
 <p><b>Ganci per marmo</b> per l'installazione di lavelli SILGRANIT® nei piani di lavoro in marmo</p>	1214697	25,00
 <p><b>Kit di fissaggio per installazione lavelli inox sottotop</b></p>	1212330	34,00
 <p><b>Chiave in gomma per smontaggio sifoni</b></p>	1139181	a richiesta
 <p><b>Set ganci di fissaggio (14 pz.)</b> per lavelli inox sopratop con spessore piano di lavoro da 28 a 4 mm</p>	1220311	a richiesta
 <p><b>Set di montaggio</b> per lavelli in SILGRANIT® per installazione sottotop</p>	1212596	a richiesta
 <p><b>Foratore per lavelli inox</b> Diametro 35 mm</p>	1137001	a richiesta
 <p><b>Fresa a tazza</b> Per effettuare fori da 35 mm di diametro nei lavelli in Silgranit®</p>	1122071	a richiesta



# Accessori per i miscelatori BLANCO

Maggiori informazioni sul sito [www.blanco.com/it](http://www.blanco.com/it) (menu "service", "ricambi e schemi di installazione")

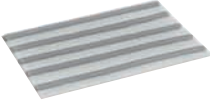
Descrizione	Codice	Euro
 <p>Chiave smontaggio rompigitto adatta ai modelli M 22x1, M 24x1, M 28x1</p>	1511324	20,00
 <p>Protezione sottolavello per i flessibili dei miscelatori</p>	1511920	51,00
 <p>Supporto supplementare per fissaggio miscelatori su lavelli inox Fornitura: Kit stabilizzatore con placca a spigolo, placca di fissaggio, 4 bulloni di fissaggio (2xM5x40 + 2xM5x70), 3 viti per legno per il fissaggio nella parte inferiore del piano di lavoro. Kit disponibile in 2 misure: Placca a spigolo da 60 mm Placca a spigolo da 75 mm</p>	1513383 1513384	51,00 51,00
 <p>Filtro per miscelatori</p>	1128434	46,00
 <p>Chiave per anello di copertura della cartuccia dei miscelatori (per es. BLANCO ALTA/-S Compact, BLANCOCULINA-S, BLANCO LINEE/-S, BLANCO LINUS/-S/-F)</p>	1139219	a richiesta
 <p>Chiave a brugola 2,5 mm per la vite di fissaggio della leva-comandi del miscelatore</p>	1139188	a richiesta
 <p>Chiave per smontaggio cartuccia dei miscelatori SW44 SW30 e SW36</p>	1127432 1127433	a richiesta a richiesta
 <p>Nastro sigillante flessibile Per l'installazione di miscelatori, saltarelli, dispenser di sapone nei piani di lavoro in laminato, con lavelli senza fascia miscelatore o in ceramica. 3 x 150 mm Istruzioni incluse.</p>	1120055	17,00

# Schemi tecnici TROPPOPIENO

## Schema montaggio troppopieno per i modelli CLARON -IF, ZEROX -IF

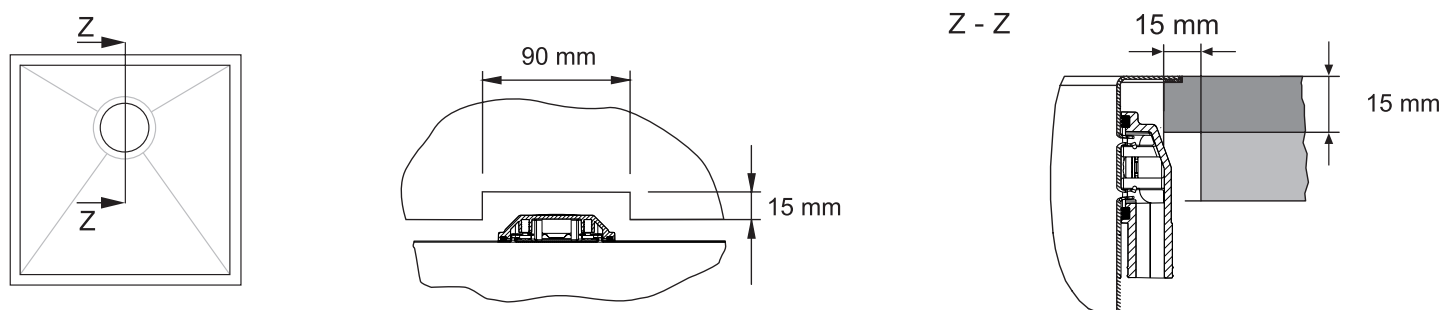

## Schema montaggio troppopieno, da considerarsi per i modelli BLANCO ANDANO -IF, SOLIS -IF, SUPRA -IF

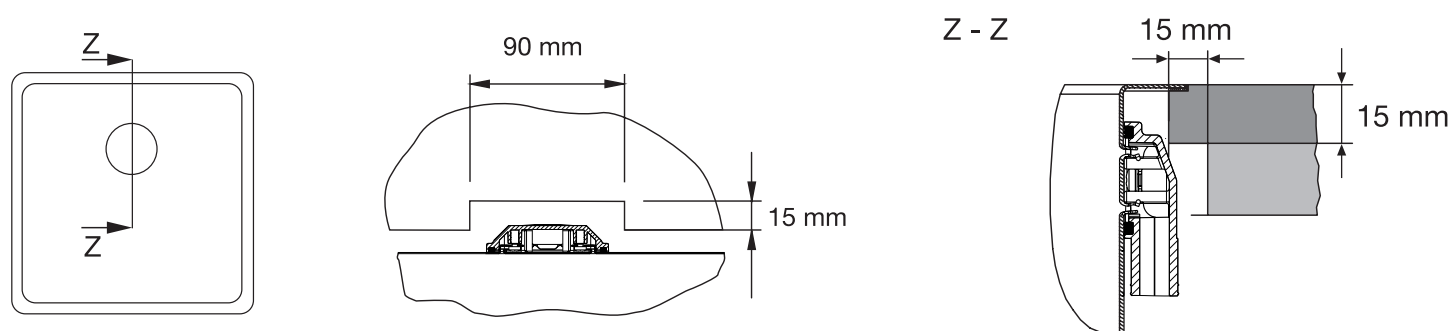

Per tutti i modelli qui sopra elencati, è necessario effettuare uno scanso nello spessore del piano di lavoro, in corrispondenza del troppopieno, per l'alloggiamento dello stesso:

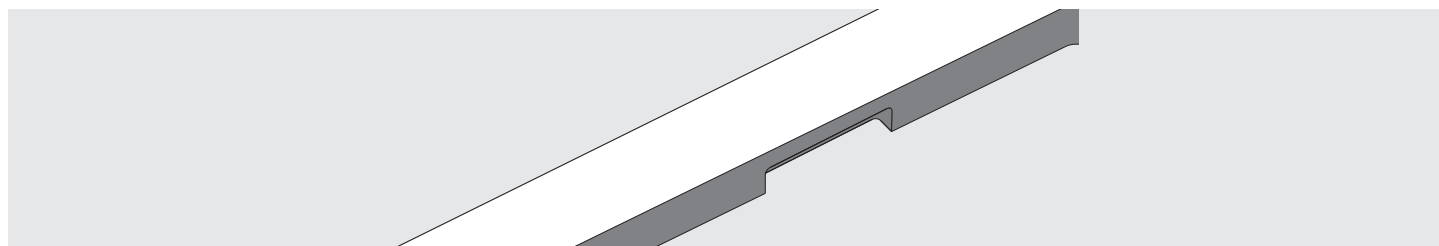

**ATTENZIONE!** I seguenti modelli **non** possono essere installati dietro il troppopieno dei modelli -IF/A (con fascia miscelatore): miscelatore BLANCO ELOSCOPE-F II, tutti i modelli di dispenser di sapone.

# PER TUTTE LE ESIGENZE.

Soluzioni di installazione BLANCO



## Installazione sopratop

Classica installazione da sopra con bordo rialzato.

- Ampia selezione di lavelli in acciaio, SILGRANIT® e ceramica
- Adatto a tutti i materiali dei piani di lavoro
- Installazione facile e veloce



BLANCO ETAGON 6 Black Edition



## Installazione -IF sopratop/filotop

Estetica elegante e moderna grazie al look semifilo.

- Ampia gamma di prodotti di lavelli in acciaio inox con bordo ribassato -IF
- L'opzione di installazione sopratop -IF è ideale per i piani di lavoro in laminato
- Un modello, due opzioni di installazione:
  - Installazione sopratop, incasso da sopra (montaggio rapido e sicuro)
  - Installazione a filotop



BLANCO LEMIS XL 6 S-IF, stainless steel



## Installazione -F filotop

Continuità visiva tra lavello e piano di lavoro, senza "gradini".  
Soluzione funzionale e contemporanea.

- Consigliato per piani di lavoro in pietra naturale o artificiale
- Collegamento permanente e sicuro tra lavello e piano di lavoro grazie ai ganci di fissaggio e alla giunzione con sigillante

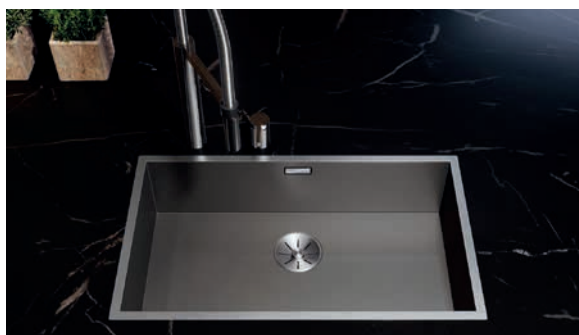

BLANCO ZEROX 700-IF Dark Steel

# PER TUTTE LE ESIGENZE.

Soluzioni di installazione BLANCO



## Installazione sottotop

Installazione fluida e continua di vasche e lavelli.

- Vasta gamma di vasche per installazione sottotop in acciaio inox, Silgranit e ceramica.
- Adatto per piani di lavoro in pietra naturale o artificiale, ceramica o vetro
- Appositi ganci di fissaggio vengono utilizzati per fissare il lavello alla parte inferiore del piano di lavoro, quindi viene fissato con il sigillante (non in dotazione).



BLANCO ANDANO 450-U in acciaio inox

## Video “Come fare a” con consigli pratici

Come si installa un lavello sottotop?

Come posso curare e mantenere nel tempo un lavello BLANCO?

Come fare un foro aggiuntivo in un lavello Silgranit?

Le risposte a queste e ad altre domande nei nostri video dimostrativi, disponibili in Internet.





# ESEMPI DI INSTALLAZIONE.

Opzioni di montaggio BLANCO



## Installazione sopratop

In questo tipo di installazione, il lavello è inserito nel foro d'incasso dall'alto.

I lavelli in acciaio inox BLANCO con bordo smussato sono dotati di guarnizione termosaldata; lavelli in SILGRANIT® o ceramica necessitano di sigillante al momento dell'installazione.

I lavelli in SILGRANIT® e in acciaio inox sono fissati al piano di lavoro da sotto tramite ganci; i lavelli in ceramica sono semplicemente appoggiati sopra di esso.

**Acciaio inox**

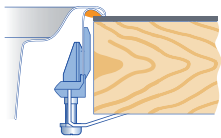

**SILGRANIT®**

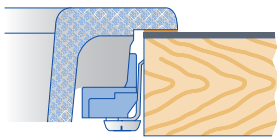

**Ceramica**

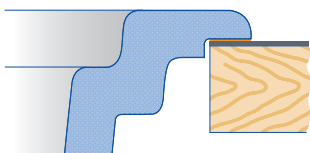

## Installazione sopratop/filotop -IF

In questo metodo d'installazione, il lavello è posto nell'intaglio da sopra. Uno strato di sigillante è applicato sotto il bordo del lavello prima della sua installazione.

I lavelli sono assicurati alla parte inferiore del piano di lavoro tramite ganci di fissaggio.

L'installazione a filotop dei lavelli -IF viene effettuata con il tradizionale metodo.

**Acciaio inox: installazione sopratop, bordo 1 mm**

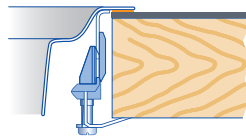

**Acciaio inox: installazione filotop**

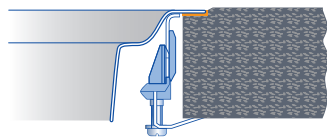

## Installazione filotop

Per l'installazione a filotop, il lavello è inserito da sopra. Abbiamo diverse tipologie di design con bordi specifici per questa installazione.

È necessaria una fresata sul piano di lavoro, riempita di sigillante.

Il lavello viene appoggiato sul sigillante, e assicurato alla parte inferiore del piano di lavoro tramite ganci di fissaggio.

**Acciaio inox**

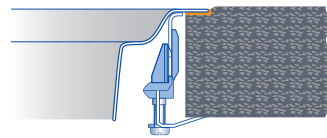

**SILGRANIT**

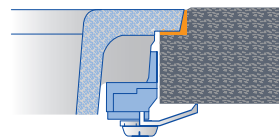

## Installazione sottotop

La speciale installazione sottopiano delle vasche BLANCO può essere effettuata nei piani di lavoro idrofughi, in materiale sintetico e pietra naturale. I piani di lavoro con spessore < 20 mm necessitano di uno spessore addizionale. Uno strato di sigillante è applicato tra il bordo del lavello e la parte inferiore del piano di lavoro.

Il lavello è assicurato al piano di lavoro da speciali ganci di fissaggio.

Tasselli speciali sono usati per gli attacchi a vite in piani di lavoro in pietra naturale o materiale composito.

**Acciaio inox: vasche sottotop**

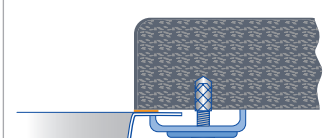

**SILGRANIT: vasche sottotop**

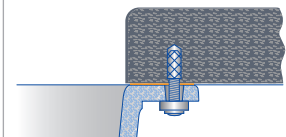

**Ceramica: vasche sottotop**

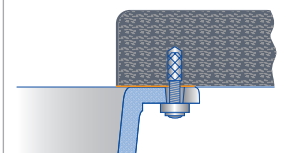

# TRE LINEE - INNUMEREVOLI POSSIBILITÀ

Comandi BLANCO per lo scarico.



**Libertà nella scelta del saltarello.** Grazie alle molte possibilità offerte dalla gamma dei comandi BLANCO, il lavello può essere ancora più personalizzato e unico.

## Comandi a saltarello ADVANCED

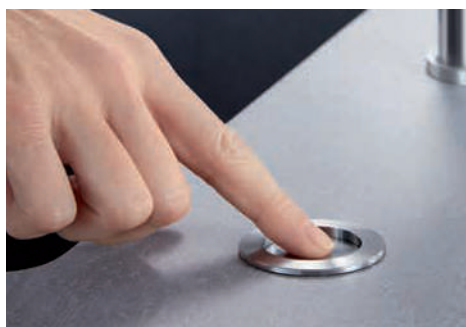

### **BLANCO PushControl**

Grazie all'intuitivo meccanismo a pressione, lo scarico è controllato con precisione e affidabilità. Il design ultra piatto da 3 mm aggiunge design, funzionalità e personalità in ogni cucina.

## Comandi a saltarello DESIGN



I comandi **DESIGN** sono la perfetta soluzione per i lavelli, in ogni cucina. La loro estetica, l'ottimale abbinamento col miscelatore e la loro funzionalità, raccontano una storia di qualità.

## Comandi a saltarello COMFORT



I saltarelli **COMFORT** sono un plus per il lavello. Forniscono un controllo affidabile dello scarico, e sono disponibili in una vasta gamma di finiture.

# COMANDI A SALTARELLO

Due passaggi per ottenere il perfetto comando dello scarico.

## Passo 1: definite lo scarico del lavello

Sistema di scarico InFino



ATTENZIONE: un tappo a cestello standard non è sostituibile da un tappo a cestello InFino®!



InFino manuale  
**SENZA** comando



InFino a saltarello  
**CON** comando

**+**

**Kit scarico a saltarello**  
Per montaggio su InFino  
1232459  
Euro 63,00



**Nessun kit retrofit necessario**  
Andare direttamente  
al punto 2 e selezionare  
un comando  
ADVANCED, DESIGN  
o COMFORT

Sistema di scarico standard



Scarico manuale  
**SENZA** saltarello

Scarico a saltarello  
**CON** comando

**+**

**Kit scarico a saltarello**  
Il codice articolo varia a seconda  
del modello di lavello  
e dalla data di fornitura  
(da comunicare al momento  
della richiesta)



**Nessun kit retrofit necessario**  
Andare direttamente  
al punto 2 e selezionare  
un comando  
DESIGN o COMFORT

## Passo 2: selezionate il comando a saltarello

### Comando saltarello ADVANCED

(solo per scarico BLANCO InFino)

BLANCO PushControl	Cod.	Euro
 Acciaio inox	1233696	85,00

\* Ø foro: 35 mm

### Comandi saltarello COMFORT

Adatti per scarico InFino e scarico standard

Comando saltarello COMFORT	Cod.	Euro
 Acciaio Satinato Opaco	1222118	181,00
Acciaio Satinato Lucido	1222115	181,00
Acciaio Spazzolato	1226540	181,00

\* Ø minimo di foratura richiesto: 14 mm

### Comando saltarello DESIGN

Adatto per scarico InFino e scarico standard

Saltarello BLANCO LIVIA	Cod.	Euro
 Cromato	1521294	125,00
Ottone satinato	1521295	171,00
Grigio Manganese	1521296	232,00
Satin Gold <b>NUOVO</b>	1526701	205,00

\* Ø minimo di foratura richiesto: 14 mm

Comando saltarello COMFORT	Cod.	Euro
 Effetto Inox	1221336	142,00
Cromato	1221339	125,00
Materiale Sintetico Cromato	1225112	74,00
Nero Opaco	1238688	181,00

\* Ø minimo di foratura richiesto: 14 mm

Comando girevole COMFORT	Cod.	Euro
 Materiale sintetico cromato	1119293	39,00

\* Ø foro: 35 mm

# Vasche e lavelli in ACCIAIO INOX 18/10

## Informativa per l'utilizzatore

La durata e l'aspetto di un lavello BLANCO in Acciaio Inox dipendono dalla qualità del suo utilizzo e da una regolare e periodica manutenzione con i prodotti BLANCO CARE consigliati.

### INFORMAZIONI GENERALI

Desideriamo informarVi relativamente alle inevitabili modifiche a cui saranno sottoposte le superfici del Vostro lavello BLANCO in acciaio inossidabile AISI 304 (18/10) e alle opportune manutenzioni. Infatti, questo materiale primeggia per lunga durata, igienicità e facilità di pulizia, ma si graffia facilmente (tranne l'acciaio inox Durinox®).

Il lavello è l'area della cucina ove avvengono la maggior parte delle azioni necessarie per la preparazione dei pasti e le successive operazioni di sbarazzo di pentole e stoviglie. Questo complesso lavoro comporta l'inevitabile modifica della "finitura di fabbrica" delle superfici del lavello, come normale usura e graduale formazione di una "patina", poi mantenuta inalterata per tutti gli anni del suo utilizzo e che dona al lavello un positivo aspetto vissuto.

Questo periodo di trasformazione varia in base al tipo di "finitura di

FINITURA DI FABBRICA	TRASFORMAZIONE	PERIODO INDICATIVO
SATINATA STEELART	RAPIDA	0-12 MESI
OPACA DA DECAPAGGIO	MEDIA	1-2 ANNI
SPAZZOLATA	MEDIA	1-2 ANNI
LUCIDATA	LENTA	2-3 ANNI
DURINOX®	LENTA	NON DEFINITO

fabbrica", alla quantità e qualità del lavoro svolto quotidianamente.

La tabella sottostante ne prospetta un'indicativa valutazione nel tempo:

### ISOLE DI ACQUA

I lavelli con finitura satinata hanno una maggiore resistenza allo "scivolamento" dell'acqua: nei primi mesi di utilizzo si formeranno delle "isole d'acqua" eliminabili con l'uso di uno strofinaccio. Queste "anomalie" sono infatti attribuibili alla viscosità dell'acqua, causata dai legami interni mobili che formano un insieme di agglomerati polimerici

a grappolo in equilibrio dinamico, denominata "tensione superficiale". Questa si traduce, nel nostro caso, in "forza adesiva" sul fondo in acciaio del lavello, ancor più pronunciata in presenza di un addolcitore nell'impianto.

### AVVERTENZE E PRECAUZIONI

La formazione di piccoli punti di ruggine, macchie e alonature, che eventualmente si possono evidenziare sulla superficie dei nostri lavelli, è da imputare a:

- Depositidi calcare che fissano lo sporco.
- Impurità presenti nella rete idrica dell'abitazione.
- Tracce di pagliette abrasive rimaste sul lavello, dopo la pulizia delle stoviglie.
- Utilizzo di prodotti contenenti cloro e fosforo come candeggina, soda caustica, stura lavandini, etc. Questi, se non ben dilavati e risciacquati, possono intaccare anche l'Acciaio inossidabile.
- Messa a bagno di alimenti sotto sale (acciughe, capperi, ...) senza un abbondante risciacquo e successiva meticolosa asciugatura con uno strofinaccio pulito.
- Se la fiorecenza di ruggine si è formata nel sottolavello, questa è causata dall'evaporazione e successiva condensa dei detersivi e dei detersivi lasciati casualmente aperti o dagli strofinacci ancora bagnati posti nel vano.
- Normale utilizzo dei detersivi, unito alla dimenticanza di un successivo buon risciacquo e asciugatura con uno strofinaccio.

### MANUTENZIONE E CURA

Tutte le eventualità sopra descritte non sono "difetti in origine", ma attribuibili a normale usura e a una non corretta manutenzione; esse sono però eliminabili con la regolare applicazione di un buon prodotto come il nostro BLANCO DeepClean, che abbina alla capacità di pulizia, una modesta azione abrasiva; utilizzato con una spugna Spontex e un panno in microfibra è sufficiente ad eliminare l'inconveniente estetico e a donare alla superficie una gradevole finitura vissuta lasciando inalterate le doti specifiche dell'Acciaio Inossidabile.

Altre eventuali informazioni si possono avere al **Numero verde 800.43.00.78** (lun.- ven. ore 9.00 - 16.00)



# Vasche e lavelli in SILGRANIT

## Informativa per l'utente

La durata e l'aspetto di un lavello Blanco in SILGRANIT dipendono dalla qualità del suo utilizzo e da una regolare e periodica manutenzione con i prodotti BLANCO CARE consigliati.

### INFORMAZIONI GENERALI:

I lavelli in SILGRANIT non scolorano, non assorbono, sono resistenti ai graffi e alle abrasioni e sopportano molto bene, e per molti anni, ogni shock termico caldo/freddo.

Il SILGRANIT è un materiale composito, in maggior percentuale sono granuli di quarzo naturale (80%) combinati con altri componenti di sintesi (acrilico e coloranti), preparato in miscele pre-colorate direttamente iniettate a caldo e con forte pressione in appositi stampi. BLANCO GmbH osserva procedure e tempi di lavorazione per garantire il completamento dei processi di solidificazione (99,9%), a tutela della salubrità delle superfici di contatto, per evitare ogni eventuale trasmigrazione dei componenti volatili di sintesi e la contaminazione dei cibi sopra posati. La formula di protezione Hygiene Plus brevettata è inoltre uno scudo contro la proliferazione batterica sulle superfici.

Le norme di produzione sono conformi a DIN EN ISO 9001:2000, DIN EN ISO 14001/2005 e EN 13310:2003 e l'inizio della produzione risale al 1979. Il materiale è assimilabile agli inerti utilizzati in edilizia e deve essere smaltito a fine vita secondo le procedure previste dalle leggi.

### AVVERTENZE E PRECAUZIONI

Il SILGRANIT ha una resistenza "critica" agli urti: se ad esempio una grossa pentola piena d'acqua, pesante diversi chili, dovesse colpire in caduta un punto qualsiasi della superficie, si causerà una frattura, così come la caduta di oggetti e barattoli dai pensili o di attrezzi appuntiti possono rovinare il lavello. Questi urti "critici", superiori al limite di rottura del materiale, possono provocare crepe subito visibili, oppure micro-crepe che si renderanno visibili dopo diversi giorni e/o settimane dall'impatto.

Queste crepe hanno come caratteristica un andamento "tremolante, a una o più direzioni," e presentano quasi sempre un punto di impatto più o meno visibile, a volte con asportazione di piccole parti di SILGRANIT,® e sono molto dissimili da crepe riconducibili a shock termico che sono invece unidirezionali e a bordi netti. Così come si possono presentare altre crepe rese visibili nei primi giorni di utilizzo in cui si è infiltrato dello sporco, che sono riconducibili a urti avvenuti per incauto maneggiamento durante le fasi di trasporto e/o montaggio in cui si è infiltrato dello sporco.

**Se inavvertitamente l'utente ponesse sopra una delle superfici del lavello una stoviglia con temperatura superiore a +200°C senza alcuna protezione, in corrispondenza si possono formare schiarimenti del colore della superficie del lavello, questo sarà più evidente nei colori più scuri della nostra gamma e nei casi più gravi l'alta temperatura può imprimere il fondo della pentola sulla superficie del lavello.**

Questo serio inconveniente può essere ridotto e, nei casi meno gravi, eliminato con un'azione abrasiva che può riportare il lavello al suo aspetto originale; il risultato ottenuto dipende dalla effettiva temperatura della pentola posta sopra alla superficie del lavello e per quanto tempo vi è rimasta. L'utilizzo di disotturanti per scarichi intasati deve essere molto prudente e attento per evitare ristagni di questi prodotti sul fondo vasca. L'alta concentrazione di cloro e fosforo, uniti all'alta temperatura che si sviluppa durante la reazione chimica, danneggerà irrimediabilmente il colore del lavello.

### MANUTENZIONE E CURA:

#### MANUTENZIONE ORDINARIA

La macchia, che si può formare sul fondo della vasca in corrispondenza dell'area colpita dal getto d'acqua del miscelatore, è causata da un sottile deposito (strato) di calcare. L'inconveniente si elimina con la manutenzione periodica, ogni settimana con prodotti anticalcare come il nostro BLANCO Dailyclean+ uniti all'azione della spugna Spontex. Per la pulizia quotidiana si consiglia l'uso di normali detersivi e spugnette abrasive non metalliche unite a un anticalcare liquido in confezione spray abbinato a una successiva azione con un detersivo in polvere per superfici dure.

#### MANUTENZIONE STRAORDINARIA

È necessaria nei casi in cui non si è praticata la manutenzione periodica sopra descritta e si è conseguentemente formato uno strato di calcare duro ed esteso sul fondo del lavello. Procedere quindi come segue:

- usare un prodotto anticalcare e lasciare agire; utilizzare poi un detersivo in polvere per superfici dure abbinato a una spugna Spontex e, con movimento rotatorio, grattare con forza la superficie, quindi dilavare con abbondante acqua ed asciugare.

- Se necessario ripetere l'operazione 1-2 volte.

Nei casi di modificazione della superficie del lavello causato da temperature superiori a 200°C, procedere come segue:

- utilizzare una carta vetrata da falegname, grana 80 o 100, e scarteggiare sino alla completa cancellazione del danno quando possibile o, almeno, sino alla sua attenuazione.

- successivamente scarteggiare il fondo e tutta la rimanente superficie del lavello con carta 300 o 500 (da carrozziere) sino a ripristinare la gradevolezza iniziale del SILGRANIT® al tatto in modo uniforme;

- ripassare infine con poche gocce di olio da cucina tutta la superficie del lavello con un panno in microfibra per rigenerare lo strato superficiale. Lavare e asciugare bene. Se il danno sulla superficie rimane visibile, il lavello dovrà essere sostituito per "negligenza d'uso".

Graffiature superficiali si possono in parte risolvere adottando la procedura sopra indicata per danni da temperature oltre +200°C.

Tutti questi casi, macchie, rotture e graffi, sono esclusi dalla Garanzia poiché successivi all'installazione e non riconducibili a difetti in origine ma a palese mancata manutenzione secondo le regole di una normale pulizia o a negligenza d'uso.

È consigliabile che l'utente presti la massima attenzione a non lasciar cadere oggetti pesanti o appuntiti sulla superficie del lavello.

# Vasche e lavelli in CERAMICA PuraPlus

## Informativa per l'utilizzatore

La durata e l'aspetto di un lavello Blanco in ceramica PuraPlus dipendono dalla qualità del suo utilizzo e da una regolare e periodica manutenzione con i prodotti BLANCO CARE consigliati.

### INFORMAZIONI GENERALI

I lavelli in ceramica PuraPlus hanno processi industriali di produzione di elevata qualità e sono disponibili in due diverse finiture e in una gamma di colori, non scolorano, sono moderatamente resistenti ai graffi, agli urti e al calcare, sono antimacchia e resistenti alle sostanze acide normalmente usate in cucina e alle soluzioni alcaline.

### AVVERTENZE E PRECAUZIONI

La resistenza ai graffi e tagli non deve essere intesa come assoluta ma limitatamente a tutte le azioni che la normale diligenza suggerisce come possibili sopra un lavello in ceramica.

La resistenza agli urti è anch'essa limitata e non assoluta in quanto se un oggetto pesante oltre il carico di rottura cade da una certa altezza sopra la superficie provocherà danni irreversibili con distacco di parti.

La resistenza al calore è anch'essa relativa, infatti, se una pentola tolta dal piano di cottura è subito posata sul lavello senza precauzione alcuna, si verificheranno fenomeni di craquelé, non più riparabili.

### MANUTENZIONE E CURA

Il lavello in ceramica PuraPlus BLANCO sono facili da pulire, la superficie è dura, non porosa, perfettamente lucida; caratteristiche che impediscono ogni assorbimento di liquidi e sporco.

La manutenzione ordinaria deve effettuarsi mediante i normali prodotti liquidi consigliati per i piatti, risciacquati, asciugati, per impedire depositi di calcare che possono catturare lo sporco e manifestarsi con macchie ed aloni antiestetici.

- La cura si effettua con i seguenti Prodotti BLANCO CARE (chiedere informazioni):
- BLANCO DailyClean+
- BLANCO DeepClean Ceramica

È consigliabile che l'utente presti la massima attenzione a non lasciar cadere oggetti pesanti o appuntiti sulle superfici del lavello.

Altre eventuali informazioni si possono avere al **Numero verde 800.43.00.78** (lun.- ven. ore 9.00 - 16.00)

# Miscelatori

## Informativa per l'utente

La durata e l'aspetto dei miscelatori Blanco dipendono dalla qualità del suo utilizzo e da una regolare e periodica manutenzione.

### INFORMAZIONI GENERALI

I miscelatori BLANCO sono disponibili in una vasta gamma; in maggior parte hanno il corpo in ottone pressofuso e, per alcune serie di alta qualità, il corpo interamente in acciaio inox.

Sono disponibili in differenti finiture: cromate, spazzolate, lucide e verniciate a caldo nei colori SILGRANIT® e ceramica.

Le doccette estraibili hanno il corpo in plastica pressofusa, in metallo cromato o interamente in acciaio inox con flessibili in diverse tipologie.

### AVVERTENZE E PRECAUZIONI

Estrarre la doccetta con il flessibile in asse con la canna del miscelatore, evitando di piegarlo a raggi stretti. Queste negligenze causano usura del flessibile con conseguenti perdite non contemplate dalla garanzia.

È indispensabile montare rubinetti d'arresto con filtro (v. foto nr. 2) per evitare il passaggio delle impurità presenti nell'impianto idrico che danneggiano i dischi ceramici della cartuccia del miscelatore, rigandoli irrimediabilmente e perdendo così la perfetta tenuta.

È molto importante eseguire una completa pulizia delle tubazioni e dei flessibili prima del collegamento al miscelatore facendo scorrere acqua per almeno due minuti in un secchio (spurgo - v. foto nr. 1)

Mal funzionamenti causati dalla mancata osservanza delle ns. avvertenze escludono ogni richiesta di garanzia.

Il montaggio della doccetta al flessibile deve essere eseguito con esperienza e cautela: inserire la guarnizione nella boccola metallica, avvitare al corpo doccetta con le mani, procedere al serraggio finale con una chiave appropriata evitando di strappare la filettatura o il corpo in plastica.

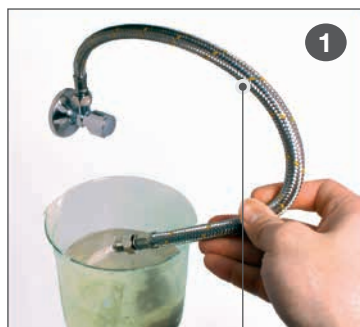

Flessibile di carico



Filtro meccanico

Rubinetto di arresto

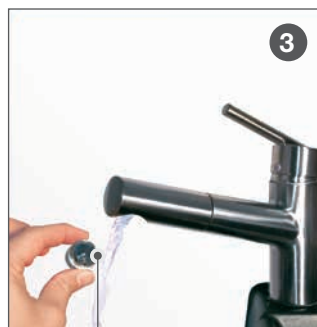

Filtro rompigitto e/o aereatore

Alcune doccette hanno la funzione "getto a doccia" che si attiva con l'apposito pulsante; per ritornare all'erogazione normale non deve essere riutilizzato il pulsante ma si deve chiudere e riaprire il monocomando.

**Le cartucce a miscelazione caldo/freddo e i filtri rompigitto sono componenti sottoposti a usura e quindi esclusi dalla garanzia.**

### MANUTENZIONE E CURA

Le acque potabili contengono diverse tipologie di impurità e di sali disciolti. Questi, pur in presenza di filtri, depuratori ed accessori, formano depositi nei dischi in ceramica, nelle doccette e nel filtro rompigitto.

**È necessario procedere quindi periodicamente alla pulizia di:**

filtro rubinetto d'arresto:	ogni 3-6 mesi
dischi in ceramica:	ogni 6-12 mesi
filtro rompigitto:	ogni 2-3 settimane (con apposita chiave)

La mancata manutenzione provocherà l'usura dei dischi in ceramica e delle guarnizioni di tenuta causando perdite e gocciolamenti nelle diverse giunzioni del corpo dei miscelatori e delle doccette (v. foto nr. 3) resi evidenti con formazione e depositi di calcare.

### PULIZIA

Rubinetti colorati, verniciati: pulire esclusivamente con un panno in microfibra utilizzando acqua o liquido per stoviglie molto diluito. Lucidare come per i rubinetti cromati, con il set DailyClean+ e panno in microfibra.

Rubinetti cromati: utilizzare esclusivamente detersivi liquidi o acqua saponata. Evitare l'uso di sostanze anticalcare se non ben diluite, spugne abrasive o acidi. Lucidare con un panno morbido in microfibra.

**Si raccomanda di non utilizzare detersivi abrasivi.**

Altre eventuali informazioni si possono avere al **Numero verde 800.43.00.78** (lun.- ven. ore 9.00 - 16.00)

# CONDIZIONI GENERALI DI VENDITA

## TRASPORTO

LOCALITÀ	TARIFFA IN %	MIN. ADDEBITO (EURO)
AREA 1		
Liguria, Piemonte, Valle D'Aosta, Lombardia, Veneto, Trentino A.A., Friuli V. G., Emilia e Romagna.	4%	n.d.
AREA 2		n.d.
Toscana, Umbria, Marche, Lazio, Abruzzo, Molise	5%	n.d.
AREA 3		n.d.
Campania, Calabria, Puglia, Basilicata, Sicilia e Sardegna	6%	n.d.
AREA 4		n.d.
Località disagiate, Isole minori, Venezia città e Laguna	trippla tariffa	n.d.

L'INVIO DI SINGOLI ACCESSORI COMPORTA L'ADDEBITO DEL TRASPORTO AL COSTO.

UN DANNO DA TRASPORTO NON DEVE ESSERE UN VOSTRO O NOSTRO DANNO!

Come comportarsi nel modo corretto.

DANNO EVIDENTE AGLI IMBALLI E/O ALLA MERCE CONTENUTA - Il destinatario deve respingere al momento della consegna la merce, indicando sul Ddt del trasportatore la dicitura "merce danneggiata".

DANNI ALL'IMBALLO - Procedere alla verifica e seguire la procedura sopra descritta. Nel caso la verifica non sia possibile in contemporanea alla consegna, apporre sui due documenti (di trasporto e di consegna) la dicitura "riserva di controllo per danni all'imballo". Il controllo dello stato della merce deve avvenire entro tre giorni dalla consegna. Questo è un dovere previsto dalla legge. In caso di avaria, parziale o totale, deve esserne data comunicazione per e-mail al trasportatore e, in copia conoscenza, via mail alla venditrice, indicando se il danno è totale o parziale.

AVARIA NON RICONOSCIBILE: DANNI OCCULTI - In questo caso il DL 286/2005 prevede l'ammissione al rimborso purché il danno sia denunciato appena conosciuto con e-mail al trasportatore e, via mail, in copia alla venditrice e comunque entro e non oltre 8 giorni dal ricevimento.

Quando non respinta al momento della consegna, la merce riconosciuta danneggiata deve essere rispedita immediatamente al magazzino di Villasanta della venditrice con la causale "reso per danni da trasporto" e con modalità di consegna "trasporto in conto servizio", completa di ogni accessorio, nessuno escluso e con lo stesso trasportatore della consegna, convenzionato con I&D. In mancanza di quanto sopra precisamente indicato, non saranno accettati reclami tardivi o incompleti. La merce sarà considerata regolarmente consegnata ed accettata senza riserve, liberando il trasportatore dei suoi obblighi, ciò in conformità ai doveri del ricevente.

Le merci a noi segnalate via mail inserite nelle procedure descritte, verranno rispedito ai clienti che ne faranno richiesta, sempre e solo in vendita.

La venditrice procederà alla emissione di "nota di accredito" a compensazione, parziale o totale, della merce danneggiata solo dopo aver verificato il rispetto delle procedure pretese dal DL 286/2005 e dopo aver ricevuto al proprio magazzino di Villasanta la merce in causa ed aver verificato con il perito del trasportatore la veridicità della denuncia contenuta nella e-mail inviata dal cliente.

## CORRETTA PROCEDURA:

Leggere il punto 5 (Trasporto) delle CONDIZIONI GENERALI DI VENDITA e procedere come sotto specificato:

- eseguire il controllo entro 3 giorni
- spedire la comunicazione al trasportatore entro 8 giorni via mail
- la comunicazione deve essere anche spedita in copia a noi via mail
- rispedito la merce danneggiata a noi con il medesimo trasportatore della consegna nel più breve tempo possibile
- trasporto a spese del trasportatore con in Ddt indicato: "TRASPORTO IN CONTO SERVIZIO"

## FAC-SIMILE E- MAIL:

Vs. intestazione	Spett.le .....
	(indirizzo del trasportatore)
Oggetto: SPEDIZIONE N° .....	del .....
Ricevuta il .....	
Mittente: I&D Srl	Peso Kg .....
	(indicare il peso totale su ns. Ddt)
Vi rendiamo noto che la merce in Ddt sopra specificata è risultata irrimediabilmente danneggiata durante il trasporto.	
Vi invitiamo a riprendere nel più breve tempo possibile il collo dal ns. magazzino e riconsegnarlo a I&D Srl a Vs. spese per le necessarie verifiche.	
Distinti saluti.	
.....	
(Firma)	

Senza questo documento non è possibile il rimborso della compagnia di assicurazione.

Inviare via mail al trasportatore e al ns. ufficio di Villasanta. I ns. uffici compileranno le pratiche, null'altro è a Voi richiesto.

Grazie per la preziosa collaborazione.

NOTE: Desideriamo informarVi che personale specializzato nostro, del trasportatore e della compagnia di assicurazione esamineranno nel dettaglio il danno denunciato e copie dei verbali saranno archiviate ai fini del DL 286/2005. In passato alcuni hanno utilizzato questa procedura in modo non corretto (danni successivi alla consegna o da incauto montaggio) rischiando serie denunce penali del perito assicurativo.



# CONDIZIONI GENERALI DI VENDITA

- 1. PRODOTTI** - I prodotti elencati corrispondono alle caratteristiche specificate nel listino distribuito ed in vigore al momento dell'ordine, integrate dal corrispondente catalogo. L'acquirente non potrà muovere obiezioni nel caso di modifiche apportate dalla venditrice ai prodotti in corso di evasione e ritenute necessarie, per esigenze costruttive e commerciali. L'acquirente riconosce che il listino è di proprietà della venditrice e, pertanto, si rende garante del suo corretto utilizzo anche da parte di terzi cui dovesse venir ceduto in uso; si rende inoltre responsabile di ogni modifica, manomissione, correzione o riproduzione anche parziale che non siano state preventivamente autorizzate per iscritto dalla proprietà.
- 2. RISERVATO DOMINIO** - Il compratore acquista la proprietà dei prodotti solo con l'integrale pagamento del prezzo, secondo le disposizioni degli articoli 1463 ss. Cod. Civ.
- 3. PREZZI** - I prezzi indicati a listino sono al netto di IVA e di Eco-contributo Erion WEEE, si intendono per consegna franco magazzino della venditrice, non comprendono il trasporto. La fornitura avviene sempre ai prezzi di listino in vigore al momento della conferma d'ordine. Nel caso di variazione dei cambi (Euro/\$) superiori al +/- 2% gli aumenti per i prodotti importati made in USA decorreranno per intero dal giorno successivo alla variazione stessa, anche nel caso Vi fossero ordini in corso di evasione. Il presente listino annulla e sostituisce ogni precedente listino, offerta o comunicazione prezzo, sia verbale che scritta e rimane valido fino al prossimo.
- 4. CONSEGNA** - Gli ordini sono evasi secondo le possibilità e le spedizioni possono anche essere parziali. Eventuali termini di consegna inseriti nella conferma d'ordine non hanno valore tassativo, ma solo indicativo. Fatte salve le ipotesi di ritardo per caso fortuito o forza maggiore, viene accordato dall'acquirente, in ogni caso, un termine di tolleranza di 45 giorni lavorativi (9 settimane).
- 5. TRASPORTO** - Fatto salvo quanto previsto al successivo punto per il trasporto in porto franco, la merce viaggia a rischio e pericolo dell'acquirente che si assume anche i rischi delle manipolazioni conseguenti alle varie operazioni di carico e scarico. La scelta del vettore, se non direttamente effettuata dall'acquirente, sarà rimessa alla venditrice senza che essa assuma responsabilità di sorta. Il prezzo del trasporto in tal caso verrà addebitato in fattura con copertura "All Risks". Nel caso l'acquirente intenda servirsi del proprio trasportatore dovrà anche provvedere personalmente all'avviso di ritiro dopo la nostra comunicazione di merce pronta. La venditrice declina ogni responsabilità al riguardo. Il servizio proposto di "porto franco" è addebitato in fattura applicando le tariffe sotto specificate, escludendo ogni sconto extra e abbuoni a qualunque titolo concessi. Il servizio addebitato si intende per consegna piano strada, fronte ingresso numero civico destino indicato in bolla. Sino a un peso limite di qt. 0,5, per pesi superiori e per colli voluminosi e pallettizzati, il destinatario dovrà prevedere allo scarico con proprio carrello elevatore o richiedere la consegna con automezzo munito di sponda idraulica.
- 6. DANNI DA TRASPORTO** - Nella sola condizione di "porto franco" la venditrice procederà al rimborso, parziale o totale, con "nota di accredito" nell'unico caso in cui il destinatario abbia proceduto alla contestazione al momento della consegna nei modi indicati nelle pagine seguenti ed in conformità al Decreto Legislativo 286/2005 dei trasporti, per quanto compete alla responsabilità del ricevente.
- 7. MANCATO RITIRO** - Nei casi di mancato ritiro della merce al momento della consegna, il maggior costo del trasporto dovuto per gli interessi di riconsegna e deposito sarà addebitato con fattura successiva, al costo richiesto dal trasportatore, se non pagato direttamente al trasportatore dal destinatario.
- 8. RECLAMI** - Eventuali contestazioni alla fornitura devono essere fatte per iscritto entro 8 giorni dal ricevimento dei prodotti dopo che gli stessi sono stati visionati, controllati e collaudati a spese dell'acquirente.
- 9. RESI** - Non si accettano resi in nessun caso
- 10. PARTI DI RICAMBIO** - La fornitura delle parti di ricambio è garantita per il periodo di anni 5 a decorrere dall'ultimo listino di vendita in cui l'apparecchio è proposto. "Nel caso in cui le merci restino esposte presso le sale esposizione o conservate nei magazzini dei nostri clienti per un periodo superiore ai 5 anni indicati, l'acquirente s'impegna a garantire alla venditrice il rimborso di quanto la stessa fosse tenuta, a sua volta, a risarcire al cliente finale per l'impossibilità di reperire parti di ricambio non più disponibili presso il produttore".
- 11. PRODOTTI ESPOSTI** - Queste vendite sono effettuate da I&D Srl praticando un extra-sconto e accettate dall'acquirente che s'impegna a tenerle esposte almeno 12 mesi e a venderle all'utilizzatore entro 24 mesi e non oltre. Qualora tale procedura non venga rispettata dall'acquirente, la venditrice declina ogni responsabilità di assistenza nei modi indicati al punto 10.
- 12. GARANZIA** - v. pag. 297-298
- 13. PAGAMENTO** - I pagamenti dovranno essere effettuati presso la sede della venditrice o presso la banca da essa delegata. L'acquirente non avrà in alcun caso il diritto di sospendere i pagamenti. In caso di ritardato pagamento, senza necessità di messa in mora, saranno addebitati, di diritto, gli interessi al tasso ufficiale di sconto, maggiorato di 4 punti, che decorreranno dal giorno della scadenza delle singole fatture. Per forniture di "rilevante importo", i pagamenti dovranno preventivamente essere concordati per iscritto. L'indicazione di eventuale banca di appoggio per il pagamento a mezzo tratte o cambiali non comporta modifiche né del rapporto causale né del foro competente. Per le vendite in contrassegno sarà applicato uno sconto extra del 2% (due per cento) del prezzo di listino con trasporto "franco di provvigioni, assegni e bolli". Per importi inferiori a 250,00 Euro (duecentocinquanta/00 Euro), l'invio sarà fatto esclusivamente in contrassegno.
- 14. CAUTELE E DECADENZE** - In caso di ritardo nei pagamenti o quando intervengano fatti che modificano la situazione finanziaria dell'acquirente o ne rendano dubbia la solvibilità, sarà in facoltà della venditrice di annullare l'ordinazione o sospendere le consegne in corso, nonché pretendere il pagamento immediato di quanto dovuto anche se non ancora scaduto.
- 15. FORO COMPETENTE** - Per ogni controversia derivante dalla interpretazione o esecuzione dei contratti di vendita stipulati in conformità alle presenti condizioni generali di vendita, sarà esclusivamente competente il foro di Monza in cui ha sede operativa la venditrice o in alternativa il foro di Milano in cui ha sede legale la venditrice.
- 16. CONDIZIONI DI VENDITA** - Il semplice inoltro dell'ordine sottintende l'attenta lettura e l'accettazione senza riserve delle condizioni sopra elencate.

# Condizioni di garanzia convenzionale e assistenza post-vendita per il programma **lavelli** e **lavelli filotop** BLANCO

Tutti i lavelli compresi nel programma BLANCO in Acciaio Inox sono prodotti esclusivamente con coil di 1<sup>a</sup> scelta - titolo 18/10 - e vengono sottoposti a rigida procedura di controllo qualità prima della loro spedizione.

Le condizioni di Garanzia Convenzionale per il programma LAVELLI e LAVELLI FILOTOP BLANCO, non prevedono interventi di assistenza post-vendita presso l'abitazione del cliente finale in quanto - e in ogni caso - eventuali difetti di materiale o di produzione sono facilmente rilevabili dal montatore che, nel caso, ne eviterà l'installazione.

Ciò premesso, qualora per cause diverse si dovesse rendere necessaria la sostituzione del lavello dopo la sua messa in opera, per vizi occulti, negligenza d'uso o altro, contattare il ns. **Numero Verde 800.43.00.78**, oppure +39 039 20.57.528/29.

In presenza dei requisiti necessari al riconoscimento del periodo di Garanzia Convenzionale e solo per difetti inequivocabilmente riconducibili alla produzione, provvederemo a istruire la pratica di sostituzione nei modi consentiti dalle leggi in vigore.

In nessun caso potranno esserci addebitati costi relativi al tecnico idraulico, elettricista, falegname o marmista eventualmente richiesti per procedere alla sostituzione del lavello.

# Condizioni di garanzia convenzionale e assistenza post-vendita per il programma **miscelatori** BLANCO

Tutti i miscelatori compresi nel programma BLANCO sono sottoposti a un rigido protocollo di controllo qualità in ogni fase della loro produzione e a un controllo finale prima della loro spedizione.

Le condizioni di Garanzia Convenzionale per il programma MISCELATORI, non prevedono interventi di assistenza post-vendita presso l'abitazione del cliente finale in quanto - e in ogni caso - eventuali difetti di materiale o di produzione sono facilmente rilevabili dal tecnico idraulico che, nel caso, ne eviterà l'installazione.

Ciò premesso, qualora per cause diverse si dovesse rendere necessaria la sostituzione del miscelatore dopo la sua messa in opera, per vizi occulti, negligenza d'uso o altro, contattare il ns. **Numero Verde 800.43.00.78**, oppure +39 039 20.57.528/29.

In presenza dei requisiti necessari al riconoscimento del periodo di Garanzia Convenzionale e solo per difetti inequivocabilmente riconducibili alla produzione, provvederemo a istruire la pratica di sostituzione nei modi consentiti dalle leggi in vigore.

In nessun caso potranno esserci addebitati costi relativi al tecnico idraulico, elettricista, falegname o marmista eventualmente richiesti per procedere alla sostituzione del miscelatore o di interventi di manutenzione per imperfetta chiusura (gocciolamento) della cartuccia in ceramica imputabili a calcare, sabbia o altro e di rottura dei flessibili/doccetta - questi imputabili a negligenza d'uso o imperfetto montaggio.

## Assistenza tecnica e post-vendita



dal lunedì al venerdì,  
dalle ore 9:00 alle ore 16:00



e-mail:  
[service@iedsrl.it](mailto:service@iedsrl.it)

oppure

**039.20.57.528/29**

Per le chiamate da cellulare, le tariffe saranno applicate dall'operatore di telefonia mobile.

# QUALITÀ CERTIFICATA.

La qualità e le certificazioni ottenute da BLANCO



BLANCO ha ottenuto la certificazione internazionale ISO 50001 per i suoi prodotti e per i suoi servizi, incrementando la soddisfazione del cliente, tenendo sempre sotto controllo l'impatto ambientale a tutela delle risorse naturali, al fine di ridurlo ulteriormente, e la certificazione per il miglioramento costante dell'efficienza energetica.

## ECO CONTRIBUTI RAEE dal 1° Febbraio 2023

TIPOLOGIA	EURO / PEZZO (IVA esclusa)*
DISSIPATORI FWD Lite	0,11
DISSIPATORI FWD Medium, Max	0,22

\*Contributo addebitato direttamente in fattura, non compreso nei prezzi indicati in questo listino

# INFORMAZIONI SUL REGOLAMENTO (CE) N. 1907/2006 (REACH)

Il REGOLAMENTO (CE) N. 1907/2006 DEL PARLAMENTO E DEL CONSIGLIO EUROPEI (REACH) del 18 dicembre 2006 disciplina la registrazione, la valutazione, l'approvazione e la restrizione delle sostanze chimiche all'interno dell'UE. Comprende anche disposizioni per la divulgazione di informazioni sulle sostanze all'interno della catena di approvvigionamento. Le sostanze particolarmente rilevanti sono specificate nell'SVHC (Substances of very high Concern - Sostanze di particolare Interesse) dell'Agenzia europea per le sostanze chimiche (ECHA) (<https://echa.europa.eu/candidatelist-table>). Il regolamento REACH è stato emanato con l'obiettivo di proteggere al meglio le persone e l'ambiente dai pericoli e dai rischi che le sostanze chimiche possono comportare. Prendiamo molto sul serio gli obblighi che ne derivano.

Lavoriamo a stretto contatto con i nostri fornitori, effettuando indagini regolari e assicurandoci conferme per garantire la conformità con i requisiti richiesti dal Regolamento (CE) n. 1907/2006 (REACH). Ciò è documentato anche in continue verifiche interne. Inoltre, i requisiti richiesti dal regolamento REACH costituiscono disposizioni vincolanti per lo sviluppo e l'approvazione dei nostri prodotti. In linea con l'articolo 33 del regolamento (CE) n. 1907/2006 (REACH), possiamo affermare che i nostri prodotti sono regolarmente controllati per le sostanze elencate nell'SVHC dell'ECHA. Se questi test rivelano sostanze che superano le quantità consentite, i nostri clienti ne verranno di conseguenza avvertiti.

I nostri miscelatori soddisfano tutti i requisiti della Direttiva CE sull'acqua potabile. I nostri sistemi per la raccolta di rifiuti soddisfano tutti i requisiti per un uso sicuro con i nostri lavelli da cucina. Ai sensi del regolamento REACH, siamo obbligati a segnalare che i nostri miscelatori, dispenser di sapone e kit pilette contengono prodotti realizzati con leghe con livelli di piombo (numero CE: 231-100-4, numero CAS: 7439-92-1) che superano la proporzione specificata dello 0,1%.



# PRECISAZIONI

- **Cartone perimetrale per lavelli** in Acciaio Inox: il cartone perimetrale consiste in un foglio di cartone posto a protezione della superficie superiore delavello con bordo scatolato salva-perimetro. È adatta a spedizioni multiple impilate su pallet. Non comprende il sifone.
- **Confezione in cartone per lavelli** in Acciaio Inox: questa confezione prevede, oltre al cartone perimetrale sopra descritto, una scatola di cartone molto robusta e completa d'inserti per rendere l'imballo il più protettivo possibile. Il sifone è sempre compreso, salvo nei pochi casi segnalati all'interno del listino.
- I lavelli in SILGRANIT® sono sempre consegnati in singole confezioni scatolate (cartone perimetrale + scatola in cartone), comprendono il sifone ma non il sigillante per il top.
- Il sifone in dotazione è del tipo salvaspazio.

## GARANZIA CONVENZIONALE

Offerta da I&D S.R.L.

L'elenco dei **Centri Assistenza autorizzati (CAT)** è soggetto a frequenti variazioni, conseguentemente è necessario contattare, **da telefono fisso**, il **Numero verde 800.43.00.78** (oppure 039.2057.528/29) disponibile tutti i giorni lavorativi **dalle ore 9:00 alle ore 16:00**.

**ATTENZIONE:** Tutte le isole minori, località montane disagiate **sono escluse dal servizio di assistenza in Garanzia Convenzionale**.

**IMPORTANTE:** è necessario che la Vostra segnalazione sia inoltrata direttamente al nostro personale, presso la nostra sede, che provvederà a ricercare la soluzione più opportuna sul piano tecnico-economico in modo e comunque di assicurare la Vostra soddisfazione di utente.

La nostra trentennale esperienza ci ha insegnato che 9 volte su 10 il Vostro problema può essere risolto al telefono con il nostro aiuto.

**PRIMA DI TELEFONARE, MUNIRSI DEI DATI - RIPORTATI IN ULTIMA PAGINA DEL LIBRETTO DI ISTRUZIONI ALLEGATO ALL'ELETTRODOMESTICO - CHE VI SARANNO SUBITO RICHIESTI DAL NOSTRO PERSONALE POST- VENDITA.**

## Testo della garanzia convenzionale allegata a ogni elettrodomestico

La Garanzia Convenzionale allegata al prodotto deve essere letta con attenzione e conservata con cura ed esibita al tecnico autorizzato ad ogni intervento tecnico.

Le avvertenze e le istruzioni per l'installazione, l'uso e la manutenzione devono essere lette e rispettate.

Le Unità sono progettate esclusivamente per un utilizzo domestico; sono pertanto esclusi tutti gli impieghi del prodotto per qualsiasi attività imprenditoriale e/o professionale pena la decadenza dei termini di garanzia.

Sono escluse dal servizio di assistenza in Garanzia Convenzionale:

- tutte le isole minori
- località montane disagiate

### PREMESSA

Questa Garanzia è offerta da I&D Srl quale "Garanzia Convenzionale" e senza in alcun modo limitare o escludere i diritti attribuiti ai consumatori dal vigente ordinamento giuridico. Tale garanzia, pertanto, è esclusa per l'uso del prodotto offerto nel listino del distributore con finalità imprenditoriale, professionale o altre collocazioni diverse da una cucina domestica e per

tutti gli elettrodomestici non "nuovi di fabbrica" e con manomissioni di qualsiasi natura, che lo rendano non conforme da quanto illustrato nel listino in vigore o sul dépliant del produttore.

1. **OGGETTO:** Il distributore garantisce la qualità ed il funzionamento dei prodotti indicati nel proprio listino con i diversi marchi commerciali. Pertanto, in caso di difetti originari del processo di fabbricazione del prodotto o dei suoi componenti, il distributore s'impegna ad eliminare i suddetti difetti con la riparazione o sostituzione del prodotto o dei suoi componenti. La riparazione o, se del caso, la sostituzione non prolungano il periodo di Garanzia convenzionale che si estinguerà in ogni caso al termine del periodo previsto di 30 mesi dalla data di consegna del prodotto acquistato.

Il prodotto deve essere utilizzato in una cucina domestica.

La presente garanzia è condizionata al rispetto da parte dell'utente delle istruzioni e delle avvertenze che sono fornite dal distributore in accompagnamento a tutti i prodotti al fine di assicurarne la corretta installazione, utilizzazione e manutenzione. È pertanto necessario che l'acquirente controlli prima dell'uso e dell'installazione la

# Testo della garanzia convenzionale allegata a ogni elettrodomestico

presenza e l'integrità della suddetta documentazione in modo da evitare ogni forma di uso improprio o di mancato rispetto di norme di legge che possano escludere le prestazioni in garanzia. In particolare è condizione di prestazione della garanzia il rispetto di tutte le disposizioni della Legge 248 02.12.2005 + D.L. 37 22.01.2008 per tutti i prodotti offerti nel listino del distributore la cui installazione e/o manutenzione rientri nell'ambito di applicazione di questa legge. Gli interventi di riparazione o di sostituzione devono essere effettuati in via esclusiva da uno dei Centri Assistenza Autorizzati che utilizzano parti di ricambio originali. È possibile contattare il più vicino Centro di Assistenza Tecnica rivolgendosi al ns. recapito di Villasanta per mezzo di richiesta telefonica o, in alternativa e per Vostra necessità di conferma, tramite invio di una e-mail.

2. DURATA E LIMITI: Il consumatore può esercitare i diritti previsti dalla presente garanzia producendo documentazione fiscalmente valida che attesti in modo inequivoco la data e l'oggetto dell'acquisto. Tale documento costituisce condizione per l'esercizio dei diritti del consumatore quale acquirente del prodotto offerto nel listino del distributore. La presente garanzia dura per un periodo di 30 mesi dalla consegna del prodotto al consumatore finale ed è soggetta alla condizione che tale consegna avvenga entro tre anni dalla data riportata sul documento di garanzia. Pertanto, le consegne di prodotto che avverranno successivamente alla data-limite sopra specificata saranno escluse da questa Garanzia Convenzionale e potranno, alle condizioni e nei termini di legge, essere oggetto eventualmente di esercizio dei diritti del consumatore secondo la legislazione vigente. Le vendite e le consegne che avverranno oltre tale termine saranno escluse dall'ambito di questa Garanzia Convenzionale, con la conseguenza che gli interventi tecnici eventualmente necessari – se richiesti al distributore - non potranno essere considerati gratuiti e saranno, pertanto, posti a carico dell'acquirente anche i costi per materiali di ricambio o di sostituzione.

3. ESTENSIONE TERRITORIALE: Il prodotto è proposto in un catalogo destinato ad una vendita e utilizzo nel Territorio Italiano e conseguentemente la Garanzia Convenzionale è valida sul territorio italiano con esclusione delle regioni: TUTTE LE ISOLE MINORI e le LOCALITÀ MONTANE DISAGIATE.

4. CAUSE DI ESCLUSIONE DALLA PRESENTE GARANZIA CONVENZIONALE:

Non sono coperti da questa Garanzia convenzionale le prestazioni e gli interventi conseguenti a:

- tecnico installatore non abilitato secondo Legge 248 02.12.2005 + D.L. 37 22.01.2008
- errata installazione
- difetti dovuti ai materiali impiegati negli allacciamenti
- difetti originati dalla non conformità alle norme vigenti degli impianti di alimentazione (elettrico, gas, acqua, canna fumaria e tubazioni di scarico) di proprietà del consumatore
- difetti originati dal non corretto dimensionamento degli allacciamenti
- mancanza del rispetto delle norme per la sicurezza degli impianti elettrici previste dalla legge 46/90
- danni da fenomeno elettrico (sbalzi di tensione)
- errata procedura di montaggio
- errata procedura di utilizzo
- negligenza d'uso
- mancata manutenzione periodica
- riparazioni eseguite da personale non autorizzato
- utilizzo di ricambi non originali
- danni da trasporto o da manipolazione
- unità usate
- mancanza del Certificato di Garanzia Convenzionale posto sull'ultima di copertina e allegato al Documento di Trasporto (DdT) in origine

I&D S.r.l. non si assume nessun obbligo di assistenza oltre il periodo previsto di 30 mesi.

Sono, inoltre, esclusi dalla presente garanzia i difetti dovuti a:

- difformità dalla descrizione fatta dal venditore
- mancanza delle qualità vantate dal venditore
- non corrispondenza alle richieste speciali fatte dal consumatore al venditore
- caratteristiche che il consumatore non poteva ignorare con l'ordinaria diligenza
- Il distributore risponde, invece, di tutte le descrizioni risultanti dai propri documenti stampati e pubblicati a propria cura.

5. LIMITAZIONI DI RESPONSABILITÀ: Il distributore declina ogni responsabilità per eventuali danni a persone, animali, cose o all'ambiente derivanti dalla mancata osservanza delle prescrizioni d'installazione, uso e manutenzione indicate sulla documentazione di istruzioni e avvertenze allegata al prodotto, sul listino e sui cataloghi in vigore al momento della vendita.

6. CONDIZIONI DI GARANZIA CONVENZIONALE I&D Srl: Le condizioni di Garanzia Convenzionale sono completate dal "Certificato", datato, da noi apposto al momento della spedizione dal nostro magazzino, nell'apposito spazio sull'ultima pagina di copertina. Questo certificato deve essere conservato sempre a Vostra cura ed esibito ad ogni intervento tecnico sia nel periodo di garanzia sia dopo, durante tutta la sua durata in esercizio. La garanzia non ha valore e decadrà qualora l'indicazione del modello e del numero di matricola riportati sul prodotto siano stati modificati, cancellati, asportati e resi comunque illeggibili. Sono esclusi anche gli interventi di manutenzione periodica, e la normale usura o logoria di utilizzo del prodotto.

I&D S.r.l. è consorziata Erion WEEE (ex Ecodom) per il ritiro a "fine vita" dell'elettrodomestico.

7. QUANDO E COME SI PUÒ USARE QUESTA "GARANZIA": Leggere le "Condizioni di Garanzia Convenzionale offerte dal distributore". Per ogni evenienza è a disposizione un servizio telefonico in grado di aiutarVi a risolvere al meglio ogni Vostro dubbio. Per accedere a questo servizio è sufficiente menzionare la Garanzia Convenzionale che Vi identifica inequivocabilmente come ns. clienti e si provvederà, se necessario, ad inviarVi il personale specializzato ed autorizzato presente nella Vs. provincia.

La durata del periodo di Garanzia Convenzionale è di 30 mesi, nei limiti previsti. Differenti promesse che prevedano una maggiore o minore durata come indicato nei dépliant del produttore, non impegnano né possono modificare le "condizioni di Garanzia Convenzionale offerte da I&D Srl". È necessario che la Vostra segnalazione sia inoltrata direttamente al nostro personale, presso la nostra sede di Villasanta, che provvederà a ricercare la soluzione più opportuna sul piano tecnico-economico in modo e comunque di assicurare la Vostra soddisfazione di utente.

- Numero Verde 800.43.00.78. Questo numero di telefono è attivo solo nei giorni feriali dalle ore 9:00 alle ore 16:00, ovvero non è disponibile nei fine settimana, nelle interruzioni per festività e nelle chiusure per i periodi feriali disposti lungo l'anno lavorativo.

- E-mail: assistenza@iedsrl.it

- È quindi Vostro interesse richiedere i riferimenti del C.A.T. locale subito dopo l'installazione dell'elettrodomestico, per evitare l'impossibilità di comunicazioni in caso di eventuali urgenze.

- Assistenza oltre il periodo di Garanzia Convenzionale (30 mesi) - Il distributore cessa ogni obbligo legale oltre il periodo previsto ed è quindi consigliabile un Vostro accordo di assistenza con il C.A.T. locale.

**OCCORRE LEGGERE E APPLICARE LE AVVERTENZE E ISTRUZIONI PER L'INSTALLAZIONE, L'USO E LA MANUTENZIONE.**

Ogni condizione proposta in questa Garanzia Convenzionale si riferisce esclusivamente ad un utilizzo in ambito domestico. Sono pertanto esclusi tutti gli impieghi dei prodotti per qualsiasi attività imprenditoriale e/o professionale.











**I&D S.r.l.**

via Cristina Trivulzio di Belgioioso, 11  
20852 Villasanta (MB)  
Tel. 039.20.57.501 r.a. - [info@iedsrl.it](mailto:info@iedsrl.it)  
[www.blanco.com/it](http://www.blanco.com/it)

